



GRP combination signal – 110 db(A)/ 5 joules, flameproof

Series YL6S

Contents

1	General information	3
1.1	Manufacturer	3
1.2	Information regarding the operating instructions.....	3
1.3	Further documents.....	3
1.4	Conformity with standards and regulations.....	3
2	Explanation of symbols	3
2.1	Symbols used in these operating instructions.....	3
2.2	Warning notes.....	4
2.3	Symbols on the device.....	5
3	Safety notes	5
3.1	Operating instructions storage	5
3.2	Personnel qualification.....	5
3.3	Safe use.....	6
3.4	Modifications and alterations	6
4	Function and device design	7
4.1	Function	7
5	Technical data.....	8
6	Transport and storage.....	10
7	Mounting and installation	11
7.1	Dimensions/fastening dimensions	11
7.2	Mounting/dismounting, operating position	12
7.3	Installation.....	13
8	Commissioning	21
9	Operation	22
9.1	Troubleshooting	22
10	Maintenance, overhaul, repair	22
10.1	Maintenance and overhaul.....	22
10.2	Repairs.....	23
10.3	Returning the device	23
11	Cleaning.....	23
12	Disposal	23
13	Accessories and spare parts.....	24

1 General information

1.1 Manufacturer

R. STAHL Schaltgeräte GmbH
Business Unit Lighting & Signalling
Nordstr. 10
99427 Weimar
Germany

Tel.: +49 3643 4324
Fax: +49 3643 4221-76
Internet: r-stahl.com
E-mail: info@r-stahl.com

R. STAHL Schaltgeräte GmbH
Am Bahnhof 30
74638 Waldenburg
Germany

Tel.: +49 7942 943-0
Fax: +49 7942 943-4333
Internet: r-stahl.com
E-mail: info@r-stahl.com

1.2 Information regarding the operating instructions

ID no.: 221664 / YL6S60300010
Publication code: 2022-03-14-BA00-III-en-05

The original instructions are the English edition.
They are legally binding in all legal affairs.

1.3 Further documents



- Data sheet
- For documents in other languages, see r-stahl.com.









1.4 Conformity with standards and regulations

IECEX, ATEX, EU Declaration of Conformity and further national certificates can be downloaded via the following link: <https://r-stahl.com/en/global/support/downloads/>.
IECEX is also available at: <http://iecex.iec.ch/>

2 Explanation of symbols

2.1 Symbols used in these operating instructions



Symbol	Meaning
	Tips and recommendations on the use of the device
	General danger
	Danger due to explosive atmosphere

-  = Flashing beacon
-  = Signal
-  = Earth connection
-  = Signal level 1
-  = Signal level 2
-  = Signal level 3
-  = Signal sound
-  = Telephone connection
-  = Volume controller





2.2 Warning notes

Warning notes must be observed under all circumstances, in order to minimise the risk resulting from design engineering and operation. The warning notes have the following structure:

- Signalling word: DANGER, WARNING, CAUTION, NOTICE
- Type and source of danger/damage
- Consequences of danger
- Taking countermeasures to avoid the danger or damage

	DANGER
	Danger to persons Non-compliance with the instruction results in severe or fatal injuries to persons.
	WARNING
	Danger to persons Non-compliance with the instruction can result in severe or fatal injuries to persons.
	CAUTION
	Danger to persons Non-compliance with the instruction can result in light injuries to persons.
NOTICE	
Avoiding material damage Non-compliance with these instructions can result in material damage to the device and/or its surroundings.	

2.3 Symbols on the device

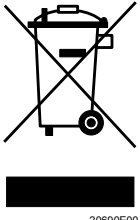
Symbol	Meaning
 0158 05594E00	CE marking according to the current applicable directive.
 02198E00	Device certified for hazardous areas according to the marking.
 15649E00	Input
 15648E00	Output
 11048E00	Safety notes that must always be observed: The corresponding data and/or safety-related instructions contained in the operating instructions must be followed for devices with this symbol!
 20690E00	Marking according to WEEE Directive 2012/19/EU

3 Safety notes

3.1 Operating instructions storage

- Carefully read the operating instructions.
- Store the operating instructions at the mounting location of the device.
- Observe applicable documents and operating instructions of the devices to be connected.

3.2 Personnel qualification

Qualified specialist personnel is required to perform the activities described in these operating instructions. This primarily applies to work in the following areas

- Project engineering
- Mounting/dismounting the device
- (Electrical) installation
- Commissioning
- Maintenance, repair, cleaning

Specialists who perform these activities must have a level of knowledge that meets applicable national standards and regulations.

Additional knowledge is required for any activity in hazardous areas!

R. STAHL recommends having a level of knowledge equal to that described in the following standards:

- IEC/EN 60079-14 (Project engineering, selection and construction of electrical systems)
- IEC/EN 60079-17 (Electrical Installations Inspection and Maintenance)
- IEC/EN 60079-19 (Equipment repair, overhaul and reclamation)

3.3 Safe use

Before mounting

- Read and observe the safety notes in these operating instructions!
- Ensure that the contents of these operating instructions are fully understood by the personnel in charge.
- Use the device in accordance with its intended and approved purpose only.
- Always consult R. STAHL Schaltgeräte GmbH if using the device under operating conditions which are not covered by the technical data.
- Make sure that the device is not damaged.
- We cannot be held liable for damage to the device caused by incorrect or unauthorised use or non-compliance with these operating instructions.



For mounting and installation

- Have mounting and installation performed only by qualified and authorised persons (see chapter "Personnel qualification").
- The device is only to be installed in areas for which it is suited based on its marking.
- During installation and operation, observe the information (characteristic values and rated operating conditions) on the rating, data and information plates located on the device.
- Before installation, make sure that the device is not damaged.

Commissioning, maintenance, repair

- Only have commissioning and repairs performed by qualified and authorised persons (see chapter "Personnel qualification").
- Before commissioning, make sure that the device is not damaged.
- Perform only maintenance work described in these operating instructions.

3.4 Modifications and alterations

	DANGER
	<p>Explosion hazard due to modifications and alterations to the device! Non-compliance results in severe or fatal injuries.</p> <ul style="list-style-type: none"> • Do not modify or change the device.
	<p>No liability or warranty for damage resulting from modifications and alterations.</p>

4 Function and device design

	DANGER
	<p>Explosion hazard due to improper use! Non-compliance results in severe or fatal injuries.</p> <ul style="list-style-type: none"> • Use the device only according to the operating conditions described in these operating instructions. • Use the device only for the intended purpose specified in these operating instructions.

4.1 Function

Application range

The YL6S product series provides both an audible and visual alarm which can be used to alert, warn or draw attention to a machine malfunction/start-up or any number of safety related issues. The audible and visual signals can be operated independently or in combination. Corrosion resistance is a key feature of the device; it is therefore ideally suited for applications in the harshest of environments, both onshore and offshore. In hazardous areas, the devices feature explosion protection for ATEX/IECEx Zones 1 & 2 for gas and 21 & 22 for dust. The device covers gas groups IIB & IIC, as well as dust protection for IIIC.

Mode of operation

The flashing beacon is considered to be an additional alarm when used for alerting/evacuating in buildings and systems.

The device is not suitable for continuous operation.

The service life of the xenon flash tubes is guaranteed for the following number of flashes:

Variant	Number of flashes
5 J	2 million

5 Technical data

Explosion protection

Global (IECEX)

Gas and dust

IECEX BAS 14.0064
 IEC 60079-0: 2011 / IEC 60079-1: 2007 / IEC 60079-31: 2013
 Ex d IIB T* Ta -** ... +** °C Gb
 Ex d IIC T* Ta -** ... +** °C Gb
 Ex tb IIIC T*** °C Ta -** ... +** °C Db IP66

Europe (ATEX)

Gas and dust

Baseefa14ATEX0126
 EN 60079-0: 2012 / EN 60079-1: 2007 / EN 60079-31: 2009
 (IEC 60079-31: 2013)
 Ⓢ II 2 G Ex d IIB T* Ta -** ... Ta +** °C Gb
 Ⓢ II 2 G Ex d IIC T* Ta -** ... Ta +** °C Gb
 Ⓢ II 2 D Ex tb IIIC T*** °C Ta -** ... +** °C Db IP66

Product variant table

Certified for temperatures in hazardous areas

Flash energy and voltage	Temperature class *	Max. Surface temperature ***	approved ambient temperature range **
5 J 24 V DC	T5	T95 °C	-60 to +40 °C
	T4	T110 °C	-60 to +55 °C
5 J 48 V DC	T5	T95 °C	-60 to +40 °C
	T4	T110 °C	-60 to +55 °C
5 J 115 V AC	T5	T95 °C	-60 to +40 °C
	T4	T110 °C	-60 to +55 °C
5 J 230 V AC	T5	T95 °C	-60 to +40 °C
	T4	T110 °C	-60 to +55 °C

Certifications and certificates

Certifications

IECEX, ATEX, Kazakhstan, Russia, Belarus

Technical data

Electrical data

Rated operational voltage	24 or 48 V DC 115 or 230 V AC					
Start-up current	24 V / 48 V DC		115 V AC		230 V AC	
	I_{max}	Duration	I_{max}	Duration	I_{max}	Duration
	17.7 A	220 μ s	21 A	500 μ s	33 A	310 μ s
Current consumption	Calculated values. Combination signal consists of two separate electrical circuits.					
	24 V DC	600 mA				
	48 V DC	420 mA				
	115 V AC	280 mA				
	230 V AC	115 mA				
Operational parameters	* Sound 1 $\pm 10\%$					
Line monitoring	Yes					

Ambient conditions

Functional ambient temperature range	24 V DC / 48 V DC: -50 to +XX* °C
	115 V AC: -40 to +XX* °C
	230 V AC: -40 to +XX* °C
	XX* max. ambient temperature see certificate

Mechanical data

Degree of protection	IP66 / IP67 (IEC/EN 60529)
Material	
Enclosure	Glass fibre reinforced polyester
Horn and trumpet	ABS, flame retardant
Lens cover	Polycarbonate
Protective grid	Stainless steel
Assembly parts	Stainless steel
Bracket	Stainless steel
Labels	Polyester foil, self-adhesive

Technical data

Acoustic data

Volume	max. 110 dB(A)	
Volume control	18 dB(A) adjustment	
Sound stages	24 / 48 V DC	3
	115 / 230 V AC	2
Tone selection	Via DIL switch	

Luminous characteristics

Light source	Xenon flash tubes	
Flash energy	5 J	
Flash rate	1/s	
Luminous intensity	Effective luminous intensity (cd)	Luminous flux (lm)
	clear	62
Lens colour	amber, red, green, opal, blue, clear, yellow, magenta	

Mounting/installation

Connection	2.5 mm ² Terminals
------------	-------------------------------

For further technical data, see r-stahl.com.

6 Transport and storage

- Transport and store the device only in the original packaging.
- Store the device in a dry place (no condensation) free of vibrations.
- Do not drop the device.

7 Mounting and installation

7.1 Dimensions/fastening dimensions

Dimensional drawings (all dimensions in mm [inch]) – Subject to change

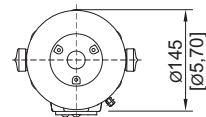
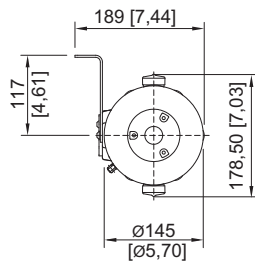
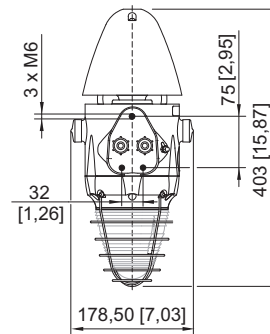
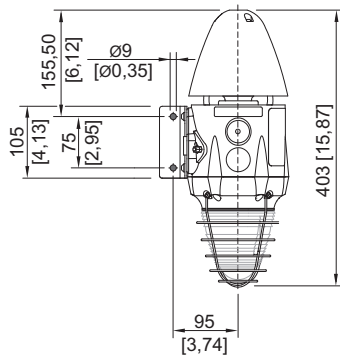

17148E00

GRP combination signal series YL6S with L-bracket

17151E00

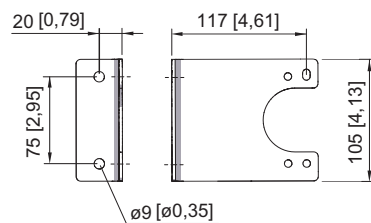

GRP combination signal series YL6S without L-bracket



17159E00

L-bracket

7.2 Mounting/dismounting, operating position

	<p style="text-align: center;">DANGER</p> <p>Explosion hazard due to improper mounting! Non-compliance results in severe or fatal injuries.</p> <ul style="list-style-type: none"> • Only operate the device if it is not damaged. If the thread is damaged, replace the device immediately. • Only install the device in a clean and dry operating environment. • Only mount the device on a wall or on a suitable surface. • Carefully protect exposed joint surfaces from damage, dust and dirt. • Install end flanges without applying force (without hammer and tool) in straight alignment. • If necessary, fit core end sleeves gas-tight and using a suitable tool.
	<p style="text-align: center;">DANGER</p> <p>Explosion hazard due to electrostatic discharge! Non-compliance results in severe or fatal injuries.</p> <p>Do not use the device in strong charge-generating environments!</p> <p>The following processes/activities should be avoided:</p> <ul style="list-style-type: none"> • Accidental friction • Particle flows
	<p style="text-align: center;">DANGER</p> <p>Explosion hazard due to open drilled holes, unused cable entries and cable glands! Non-compliance results in severe or fatal injuries.</p> <ul style="list-style-type: none"> • Only use cable entries and stopping plugs that have been separately checked and certified in accordance with Directive 2014/34/EU (ATEX) and IECEx (CoC), and which technically correspond to the state of technology given in the certificate. • The IP level of protection of the cable entries and stopping plugs must at least correspond to the IP level of protection of the device (see marking on the device). • When selecting cable entries, observe the type of thread and thread size in the component documentation. • Seal the thread with non-curing thread sealant in order to guarantee the IP66 degree of protection. • Always close unused drilled holes, cable entries and cable glands using approved stopping plugs or plugs. Observe IEC/EN 60079-14 for this. • Installation of the cable gland must be performed in accordance with the manufacturer's instructions. • The cable entry temperature may exceed 70 °C.

- Mount the device on a flat surface suitable for its weight.
- Direct the tone output towards the area to be covered.
- Insert the electrical lines using a certified and flameproof cable entry which is suitable for the gas group.
- Close unused entries using certified, flameproof stopping plugs.

7.3 Installation

The electrical installation and configuration of the device is performed in the following sequence:

- Dismounting the device (see chapter 7.3.1)
- Electrical connections (see chapter 7.3.2)
- Configuration (see chapter 7.3.3)
- Mounting the device (see chapter 7.3.4)
- Mounting the earth connection (see chapter 7.3.5)
- Adjusting the volume (see chapter 7.3.6)

7.3.1 Dismounting the device

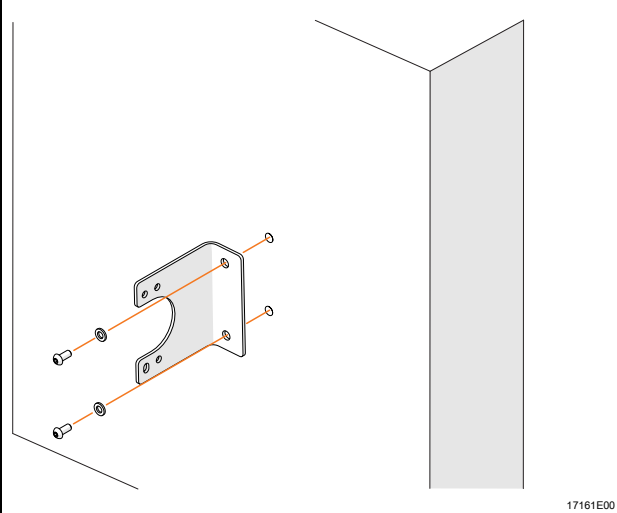
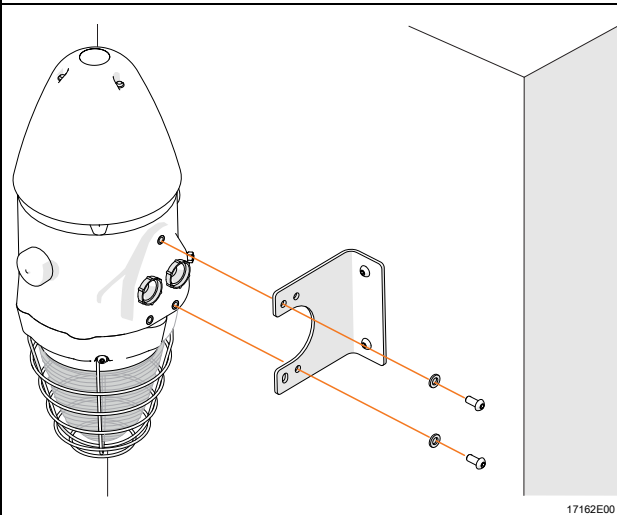
 <p>17161E00</p>	<ul style="list-style-type: none"> • Fix the bracket to the wall.
 <p>17162E00</p>	<ul style="list-style-type: none"> • Mount the device.

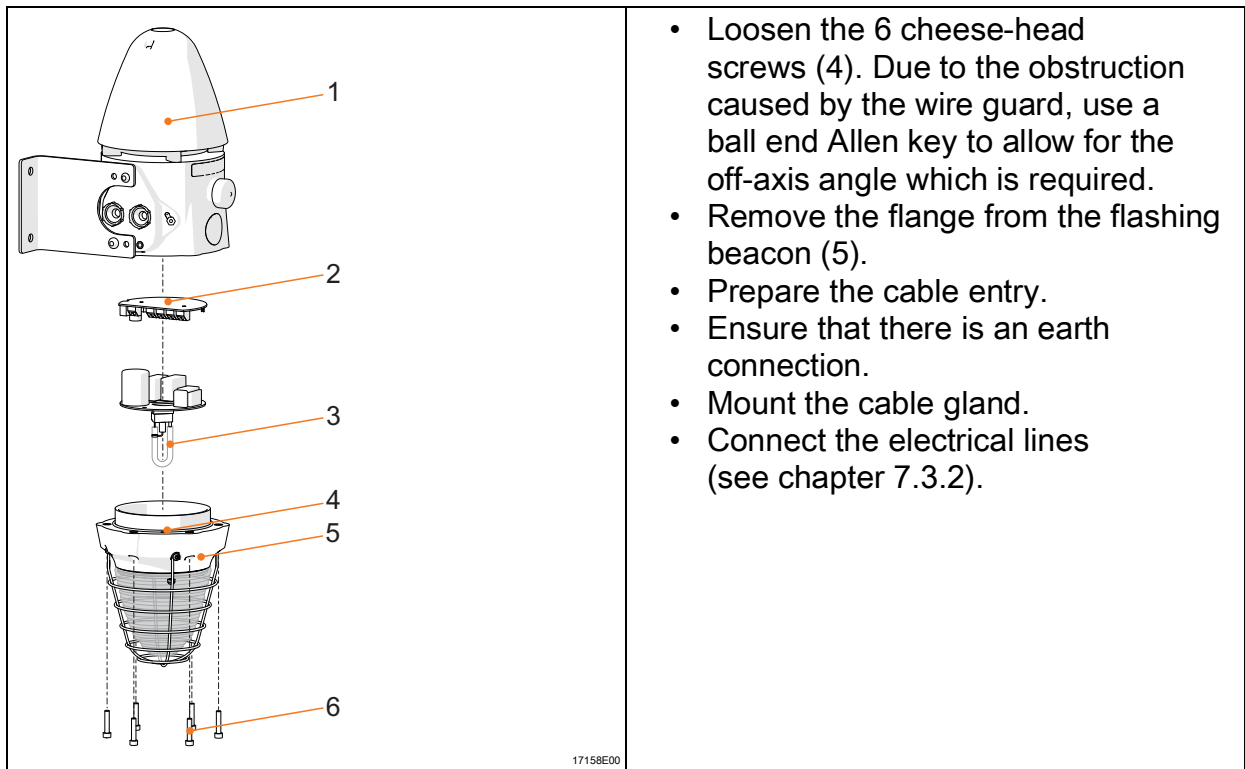

- Loosen the 6 cheese-head screws (4). Due to the obstruction caused by the wire guard, use a ball end Allen key to allow for the off-axis angle which is required.
- Remove the flange from the flashing beacon (5).
- Prepare the cable entry.
- Ensure that there is an earth connection.
- Mount the cable gland.
- Connect the electrical lines (see chapter 7.3.2).

- 1 Horn
- 2 PCB
- 3 Xenon flash tubes

- 4 Seal
- 5 Flashing beacon flange
- 6 M5 x 25 cheese-head screws

7.3.2 Electrical connections

i	<ul style="list-style-type: none"> Do not touch the xenon flash tubes when installing/mounting the device.
----------	---

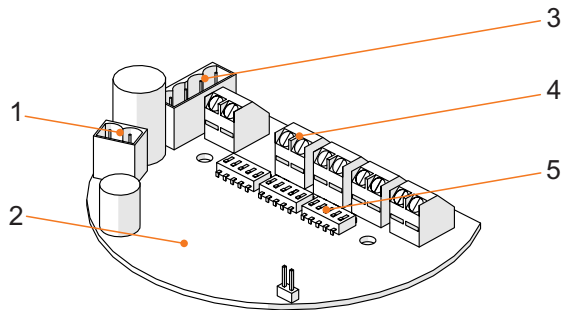

17163E00

YL6S

- | | | | |
|---|-----------------------------------|---|---|
| 1 | Connector for horn | 4 | Terminal blocks |
| 2 | PCB termination board | 5 | Sound selection switch
(see sound table) |
| 3 | Connector for flash circuit board | | |

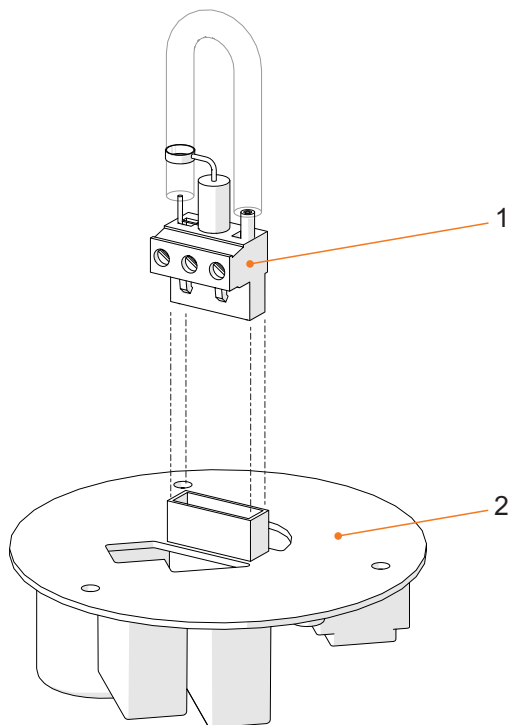

17164E00

YL6S

- | | | | |
|---|-------------------|---|---------------------|
| 1 | Xenon flash tubes | 2 | Flash circuit board |
|---|-------------------|---|---------------------|

Cable connection

i	<ul style="list-style-type: none"> The connection terminal is suitable for electrical lines with a cross section of 2.5 mm² or 14 to 18 AWG.
----------	--

Parallel connection of several devices

Up to 10 devices can be connected to a supply line in parallel.

Circuit diagrams

i	<p>Line monitoring for devices with direct voltage</p> <ul style="list-style-type: none"> Through reverse polarity By connecting an EOL resistor between 0 V and +V. The resistance value is defined by the system developer
----------	---

i	<p>Two signal levels for devices with direct voltage</p> <ul style="list-style-type: none"> Through reverse polarity By connecting a third electrical line <p>Two signal levels for devices with alternating voltage</p> <ul style="list-style-type: none"> By connecting a third electrical line
----------	--

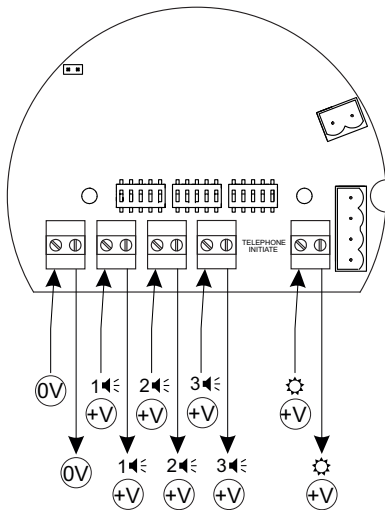

Circuit diagram for direct voltages

17194E00

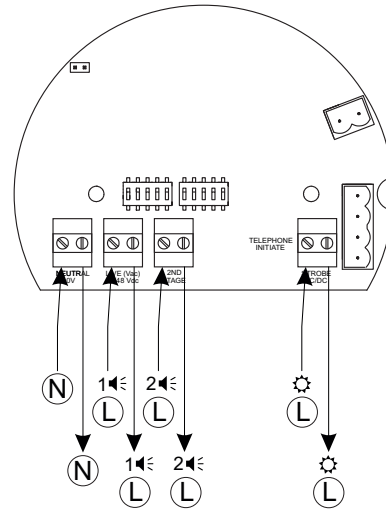

Circuit diagram for alternating voltages

17193E00

7.3.3 Configuration

i	<p>Recommendation</p> <ul style="list-style-type: none"> The signal tone selection should be set at the factory or at an approved factory.
i	<p>Do not use tone 12, 14 and 32 for AC variants.</p>

- For signal tone selection and its switch positions, refer to the table below.
- Check whether the switch positions are correct for the selected signal tones

Details of sound selection switch

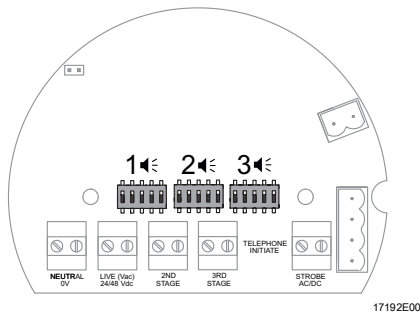

Audible settings

Sound no.	SW1/SW2					Frequency	Repetition rate	Sound description	Special application
	SW x.1	SW x.2	SW x.3	SW x.4	SW x.5				
01	0	0	0	0	0	500 to 1200 Hz	3 s	Siren	
02	1	0	0	0	0	1200 to 500 Hz	1 s	Reverse sweep	Fire alarm, Germany (DIN 33404)
03	0	1	0	0	0	500 to 1200 Hz	4.5 s	Slow wailing sound	Evacuation, Netherlands
04	1	1	0	0	0	500 to 1000 Hz	0.15 s	Fast wailing sound	
05	0	0	1	0	0	800 to 1000 Hz	As standard	ISO 8201 Evacuation	International evacuation alarm
06	1	0	1	0	0	1000 Hz	10/40/10 s	Constant rise and fall	

Sound no.	SW1/SW2					Frequency	Repetition rate	Sound description	Special application
	SW x.1	SW x.2	SW x.3	SW x.4	SW x.5				
07	0	1	1	0	0	250 to 1200 Hz	0.085 s	Fast siren	
08	1	1	1	0	0	1400 Hz	0.25 s	Interrupted, fast, rising volume	
09	0	0	0	1	0	720 Hz	0.7/0.3 s	Interrupted sound	Industrial alarm, Germany
10	1	0	0	1	0	700 Hz	0.25 s	Interrupted sound	Local warning, Sweden
11	0	1	0	1	0	700 Hz	4 s	Interrupted sound	Air-raid alarm, Sweden
12	1	1	0	1	0	1000 Hz	1 s	Interrupted sound	
13	0	0	1	1	0	700 Hz	6/12 s	Interrupted sound	Important message, Sweden
14	1	0	1	1	0	2500 Hz	0.5 s	Interrupted sound	
15	0	1	1	1	0	2500 Hz	0.25 s	Interrupted sound	
16	1	1	1	1	0	100 Hz	0.5 s	Interrupted sound	
17	0	0	0	0	1	420 Hz	1.25 s	Interrupted sound	AS2220, Australia
18	1	0	0	0	1	1000 Hz	2 s	Interrupted sound	
19	0	1	0	0	1	440 Hz	–	Continuous tone	
20	1	1	0	0	1	2300 Hz	–	Continuous tone	
21	0	0	1	0	1	1000 Hz	–	Continuous tone	

Sound no.	SW1/SW2					Frequency	Repetition rate	Sound description	Special application
	SW x.1	SW x.2	SW x.3	SW x.4	SW x.5				
22	1	0	1	0	1	1000 Hz	–	Continuous tone	
23	0	1	1	0	1	700 Hz	–	Continuous tone	All clear, Sweden (SS 031711)
24	1	1	1	0	1	440 to 554 Hz	2 s	Two alternating tones	Turn out, Sweden (SS 031711)
25	0	0	0	1	1	2500 to 3200 Hz	0.07 s	Two alternating tones	
26	1	0	0	1	1	800 to 1000 Hz	0.13 s	Two very quickly alternating tones	
27	0	1	0	1	1	430 to 470 Hz	1 s	Two alternating tones	
28	1	1	0	1	1	440 to 554 Hz	04/0.1 s	Two alternating tones	AFNOR, France
29	0	0	1	1	1	2500 to 3100 Hz	0.25 s	Two quickly alternating tones	Security deterrent
30	1	0	1	1	1	800 to 1000 Hz	0.25 s	Two quickly alternating tones	Increased urgency/ level crossing
31	0	1	1	1	1	2500 to 3100 Hz	0.5 s	Two alternating tones	Security alarms
32	1	1	1	1	1	800 to 100 Hz	0.5 s	Two alternating tones	Fire service/ level crossing

The PFEER audible signals recommended by UKOOA are:

General alarm

Audible signal 15

Interrupted tone 1000 Hz

PAPA

Audible signal 31

Reverse sweep 1200 to 500 Hz

Toxic gas

Audible signal 11

Continuous tone 1000 Hz

7.3.4 Mounting the device

- Lift the flashing beacon flange towards the device.
- Connect the PCB using the connector.
- Mount the flashing beacon flange.
- Replace the M5 x 25 cheese-head screws and tighten them to a tightening torque of 4 Nm.

i

Screws and seals

The cheese-head screws are delivered with Nyltite seals.

- Before mounting, check the seals for damage.
- Replace damaged seals.
- Use seals a maximum of 5 times.
- When using screws on a flat surface, note the seal on the screw head – see figure.

15748E00

7.3.5 Mounting the earth connection

Use of metallic cable entries

A slip on earth tag is provided for each device.

- Connect the slip on earth tag to the external earth bolt.

Device material

The GRP material used for the enclosure has electrically conductive properties.

The material is antistatic and prevents the build-up of electrical charges on its surface.

Surface resistivity <math>< 10^8 \Omega</math> according to IEC/EN 60093.

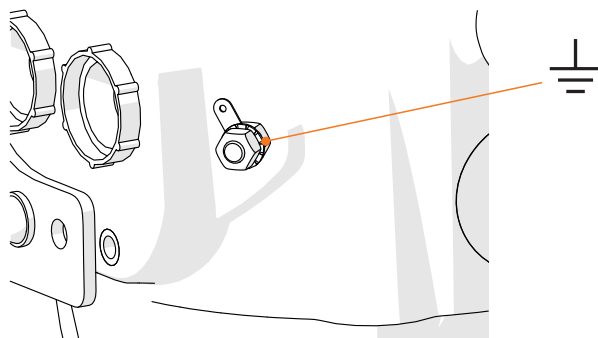

17191E00

7.3.6 Adjusting the volume

The maximum volume (depending on the selected sound) can be reduced by about 18 dB(A) using the potentiometer.

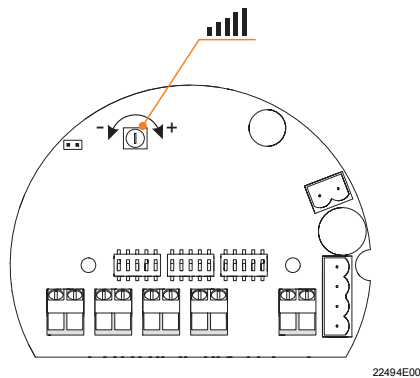

8 Commissioning

	DANGER
	<p>Explosion hazard due to incorrect installation! Non-compliance results in severe or fatal injuries.</p> <ul style="list-style-type: none"> • Check the device for proper installation before commissioning. • Comply with national regulations.

Before commissioning, ensure that:

- the device has been installed according to regulations.
- the line voltage and the rated operational voltage of the device are consistent.
- the permissible cable diameter for the cable entries has been used.
- the cable entries and stopping plugs have been securely tightened.
- the electrical lines have been inserted correctly.
- the connection has been performed correctly.
- all screws and nuts have been tightened according to regulations.
- the connection chamber is clean.
- the device is not damaged.
- there are no foreign objects inside the device.
- the device is closed according to regulations.
- the flash circuit board is inserted.

9 Operation

The device is used to warn and alert by means of

- an audible signal.
- a visual signal.

24 V DC and 48 V DC voltage variants – visual signal

i	At temperatures below -40 °C, stabilization of the flash rate may be delayed.
----------	---

9.1 Troubleshooting

If an error occurs please re-visit the earlier sections of this document.

If the error cannot be eliminated using the specified procedures:

- Contact R. STAHL Schaltgeräte GmbH.

For rapid processing, have the following information ready:

- Type and serial number of the device
- Purchase information
- Error description
- Intended purpose (especially input/output circuit)

10 Maintenance, overhaul, repair

10.1 Maintenance and overhaul

- Consult the relevant national regulations to determine the type and extent of inspections.
- Tailor inspection intervals to the operating conditions.
- Perform maintenance and repair work in accordance with IEC 60079-17 and IEC 60079-19.

i	Observe the relevant national regulations in the country of use.
----------	--

At a minimum, check the following points during maintenance on the device:

- Whether the clamping screws holding the electrical lines fit securely
- Whether the device has cracks or other visible signs of damage
- Whether the seals have aged or been damaged
- Whether the permissible temperatures are complied with (according to EN 60079)
- Whether the device is used as intended and functions properly

10.2 Repairs

	DANGER
	<p>Explosion hazard due to improper repair! Non-compliance results in severe or fatal injuries.</p> <ul style="list-style-type: none"> • Repair work on the devices must be performed only by R. STAHL Schaltgeräte GmbH.

10.3 Returning the device

- Only return or package the devices after consulting R. STAHL!
Contact the responsible representative from R. STAHL.

R. STAHL's customer service is available to handle returns if repair or service is required.

- Contact customer service personally.

or

- Go to the r-stahl.com website.
- Under "Support" > "RMA" > select "RMA-REQUEST".
- Fill out the form and send it.
You will automatically receive an RMA form via email. Please print this file off.
- Send the device along with the RMA form in the packaging to R. STAHL Schaltgeräte GmbH (refer to chapter 1.1 for the address).

11 Cleaning

- Devices located in hazardous areas may only be cleaned with a damp cloth to avoid electrostatic charge.
- When cleaning with a damp cloth, use water or mild, non-abrasive, non-scratching cleaning agents.
- Do not use abrasive cleaning agents or solvents.

12 Disposal

- Observe national, local and statutory regulations regarding disposal.
- Separate materials for recycling.
- Ensure environmentally friendly disposal of all components according to statutory regulations.

13 Accessories and spare parts

NOTICE

Malfunction or damage to the device due to the use of non-original components.
Non-compliance may lead to material damage!

- Use only original accessories and spare parts from R. STAHL Schaltgeräte GmbH.



For accessories and spare parts, see the data sheet on our homepage r-stahl.com.

EU-Konformitätserklärung
EU Declaration of Conformity
Déclaration de Conformité UE



R. STAHL Schaltgeräte GmbH • Am Bahnhof 30 • 74638 Waldenburg, Germany
 erklärt in alleiniger Verantwortung, *declares in its sole responsibility, déclare sous sa seule responsabilité,*

dass das Produkt: **Akustische und optische Signalgeräte**
that the product: *Audible and visual signalling devices*
que le produit: *Appareil de signalisation sonore et lumineux*

Typ(en), type(s), type(s): **YL6S, YA6S, FL6S**

mit den Anforderungen der folgenden Richtlinien und Normen übereinstimmt.
is in conformity with the requirements of the following directives and standards.
est conforme aux exigences des directives et des normes suivantes.

Richtlinie(n) / Directive(s) / Directive(s)	Norm(en) / Standard(s) / Norme(s)
---	-----------------------------------

2014/34/EU ATEX-Richtlinie	EN 60079-0:2012 + A11:2013
2014/34/EU <i>ATEX Directive</i>	EN 60079-1:2014
2014/34/UE <i>Directive ATEX</i>	IEC 60079-31:2013

Kennzeichnung, marking, marquage:  **II 2 G Ex d IIB/ IIC T6 ... T4 Gb** **CE 0158**
 II 2 D Ex tb IIC T73°C ... T113 °C Db

EG-Baumusterprüfbescheinigung: **Baseefa 14 ATEX 0126**
EC Type Examination Certificate: *(SGS Fimko Oy,*
Attestation d'examen CE de type: *Särkiniementie 3, P.O. Box 30, FI-00211 Helsinki, Finland)*

Produktnormen nach Niederspannungsrichtlinie: EN 60598-1:2015 + A1:2018
Product standards according to Low Voltage Directive: EN 62471:2008
Normes des produit pour la Directive Basse Tension:

2014/30/EU EMV-Richtlinie	EN 50130-4:2011 + A1:2014
2014/30/EU <i>EMC Directive</i>	EN 61000-3-2:2014
2014/30/UE <i>Directive CEM</i>	EN 61000-3-3:2013
	EN 61000-6-3:2007 + A1:2011 + AC:2012

2011/65/EU RoHS-Richtlinie	EN IEC 63000:2018
2011/65/EU <i>RoHS Directive</i>	
2011/65/UE <i>Directive RoHS</i>	

Waldenburg, 2021-02-08

Ort und Datum
Place and date
Lieu et date

i.V.

Dr. C. Chevalier
Vice President BU Lighting & Signalling
Vice-Président BU Eclairage & Appareils de signalisation

i.V.

J. Freimüller
Vice President global Quality Management
Vice-Président globale Gestion de Qualité