



**Project planning, installation and commissioning of the RS 485 field bus system
of R. STAHL for the safe and hazardous area**

**Project planning, installation and commissioning of the RS 485 field bus system
of R. STAHL for the safe and hazardous area**

R. STAHL Schaltgeräte GmbH
Am Bahnhof 30
D-74638 Waldenburg (Württemberg)
Germany

Ordering code

Version: 2.1

Date of issue: 11.12.2017

Applicable to: I.S. 1

Target group:

Trained qualified staff
(in accordance with ElexV, IEC 79-17)

Subject to change and correction without notice



Operating Instructions

Project planning, installation and commissioning of the RS 485 field bus system of R. STAHL for the safe and hazardous area



Project planning, installation and commissioning of the RS 485 field bus system of R. STAHL for the safe and hazardous area

Contents	Page
1. Introduction.....	4
2. Compatibility.....	4
3. Definitions.....	4
4. Project planning.....	5
4.1. Safe area.....	5
4.2. Hazardous area.....	5
4.3. Upgrade from RS 485 Ex i to RS 485-IS Installation.....	10
4.4. Usable components.....	11
4.5. Bus length RS 485, RS 485-IS and RS 485 Ex i.....	11
4.6. Extending the network structure.....	12
4.7. Address space of the bus protocols.....	12
4.8. Number of fieldbus devices of an RS 485 segment.....	12
4.9. Number of fieldbus devices of an intrinsically safe RS 485-IS or RS 485 Ex i bus segment.....	12
4.10. Fieldbus cable.....	13
4.11. Proof of intrinsic safety of a fieldbus installation.....	13
4.12. Maximum number of series-connected repeaters.....	18
4.13. Sub-D connector for the fieldbus.....	19
4.14. Additional terminating resistors for the RS 485 Ex i fieldbus according to the R.STAHL specification when type 9373/21 or 9372/.. fieldbus isolating repeaters are used.....	20
4.15. Earthing of the conductive shielding of an intrinsically safe fieldbus.....	21
4.16. Design of safe isolation of the fieldbus cable shielding.....	22
5. Installation.....	23
5.1. Important information on installation and project planning rules.....	23
5.2. Cable laying.....	23
5.3. Connection of the Sub-D connectors and Profibus cables.....	23
5.4. Installation location and connection of the fieldbus isolating repeaters.....	25
5.5. Measurement of the Profibus cable.....	25
6. Commissioning.....	26
6.1. Bus segment in the safe area.....	26
6.2. Bus segment in the hazardous area.....	26
6.3. Checking and setting the fieldbus devices.....	27
6.4. Commissioning the master.....	27
7. Troubleshooting.....	28
7.1. Troubleshooting with simple measuring instruments, procedure.....	29



Project planning, installation and commissioning of the RS 485 field bus system of R. STAHL for the safe and hazardous area

1. Introduction

The R. STAHL Schaltgeräte GmbH company marketed an intrinsically safe Remote I/O System as early as 1997: the VOS200.

An intrinsically safe variant of the PROFIBUS DP, developed by STAHL, was used for coupling VOS200 to automation systems. This meant that, for the first time, it was possible to achieve transfer rates of up to 1.5 Mbit/s in the hazardous area, a speed which greatly exceeds the 31.75 kbits/s used on PROFIBUS PA in the Ex i segment.

The transmission system used on VOS200 will also be used on the successor system, the Remote - I/O System I.S.1. However, owing to the EX approval, only specifically approved components of R. STAHL may be connected to such an Ex i bus segment.

The existing solution has been further developed in cooperation with other manufacturers, under the umbrella of the PNO (PROFIBUS User Organisation). The new specification named RS 485-IS was released in mid-2003 as Profibus guideline:

“Profibus RS 485-IS User and Installation Guideline; Number 2262 Rev. 1.1 ” dated June 2003. On the basis of this guideline, it will be possible to operate devices produced by different manufacturers jointly on an intrinsically safe bus segment.

2. Compatibility

Components complying with the previous RS 485 Ex i Specification in accordance with R. STAHL and components in accordance with RS485-IS Specification **cannot** be mixed in one bus segment since functional characteristics differ.

When planning an intrinsically safe RS 485 segment, it is necessary to define which of the two specifications the segment is designed to comply with.

New devices of R. STAHL comply with the RS 485-IS specification.

3. Definitions

RS 485: Fieldbus in safe areas based on a standard RS 485 interface

RS 485 Ex i: Intrinsically safe fieldbus based on the R. STAHL specification

RS 485-IS: Intrinsically safe fieldbus based on the PNO (Profibus User Organisation) specification

Project planning, installation and commissioning of the RS 485 field bus system of R. STAHL for the safe and hazardous area

4. Project planning

4.1. Safe area

The field bus must be executed as a linear system. In general the start of the bus is formed by the bus interface module of a DCS (Automation System), a repeater or an isolating repeater. The end of the bus is formed by the terminating resistor or a repeater. Fieldbus devices of the most varied types can be arranged along the bus. For example, these can be the R. STAHL remote I/O system I.S. 1, the R. STAHL VOS 200 system, R. STAHL HART multiplexer, devices from other manufacturers, repeaters or fieldbus isolating repeaters. A maximum of 32 devices may be connected to an RS 485 segment. Should a greater number of fieldbus devices be connected together by means of an RS 485 interface, a repeater must be fitted into the line after 31 devices (bus master and repeater are considered as one user or device). After the repeater, a further 31 users are allowed.

4.2. Hazardous area

Certain restrictions further to what is said above must be noted within the hazardous area.

4.2.1. The following is defined for the intrinsically safe RS 485-IS bus in accordance with the PNO Guideline

1. The number of bus users has been limited to 32 per physical segment.
2. A continuation of the intrinsically safe segment by means of a repeater is possible.
3. The RS 485-IS is terminated on both ends with matched terminating resistors (these must be approved for use in Zone 1). R. STAHL supplies corresponding connectors.
4. The bus structure may be similar to that in the safe area.
5. The bus cable used must have an L/R ratio $< 15 \mu\text{H}/\Omega$ and an effective capacitance of $< 30 \text{ pF}/\text{m}$.
6. Safety-related verification of the intrinsically safe bus segment can be provided on the basis of the L/R calculation conform to EN 60 079-11 or using the PTB 04 ATEX 2089, 1. Supplement "Intrinsically safe fieldbus system type RS 485-IS or RS 485 Ex i" system certificate.
7. Only approved Sub-D connectors can be used for this purpose. The connectors may not contain concentrated inductances or capacitances. R. STAHL provides the respective Sub-D connectors which meets these demands.



Project planning, installation and commissioning of the RS 485 field bus system of R. STAHL for the safe and hazardous area

4.2.2. The following is defined for the intrinsically safe RS 485 Ex i bus in accordance with R. STAHL Specification

1. The number of fieldbus devices is limited to 11 per physical segment (1 field bus isolating repeater and 10 fieldbus devices). An extension of the Ex i stub line segment using a fieldbus isolating repeater is not possible.
2. A segment of the RS 485 Ex i bus is always a stub line of an RS 485 segment separated via a fieldbus isolating repeater.
3. Should more than 10 Ex i field bus devices be connected to a logical bus segment, then further fieldbus isolating repeaters parallel to the RS 485 segment have to be provided.
4. The fieldbus isolating repeater always forms the start of an RS 485 Ex i bus segment.
5. The terminating resistors in an RS 485 Ex i bus segment must be connected in the fieldbus isolating repeater and at the far end of the segment.
6. The terminating resistor inside the fieldbus isolating repeater is connected internally to + and 0 V via additional resistors.
7. The terminating resistor at the far end of the segment consists of a single resistor and not 3 resistors as in a RS 485 segment.
8. The bus cable used must have an L/R ratio $< 15 \mu\text{H}/\text{Ohm}$ and an effective capacitance of $< 30 \text{ pF}/\text{m}$.
9. Safety-related verification of the intrinsically safe bus segment can be provided on the basis of the L/R calculation conform to EN 60 079-11 or using the PTB 04 ATEX 2089, 1. Supplement "Intrinsically safe fieldbus system type RS 485-IS or RS 485 Ex i" system certificate.
10. Only the Sub-D connectors provided by R.STAHL are permitted.

Project planning, installation and commissioning of the RS 485 field bus system of R. STAHL for the safe and hazardous area

4.2.3. Project planning examples

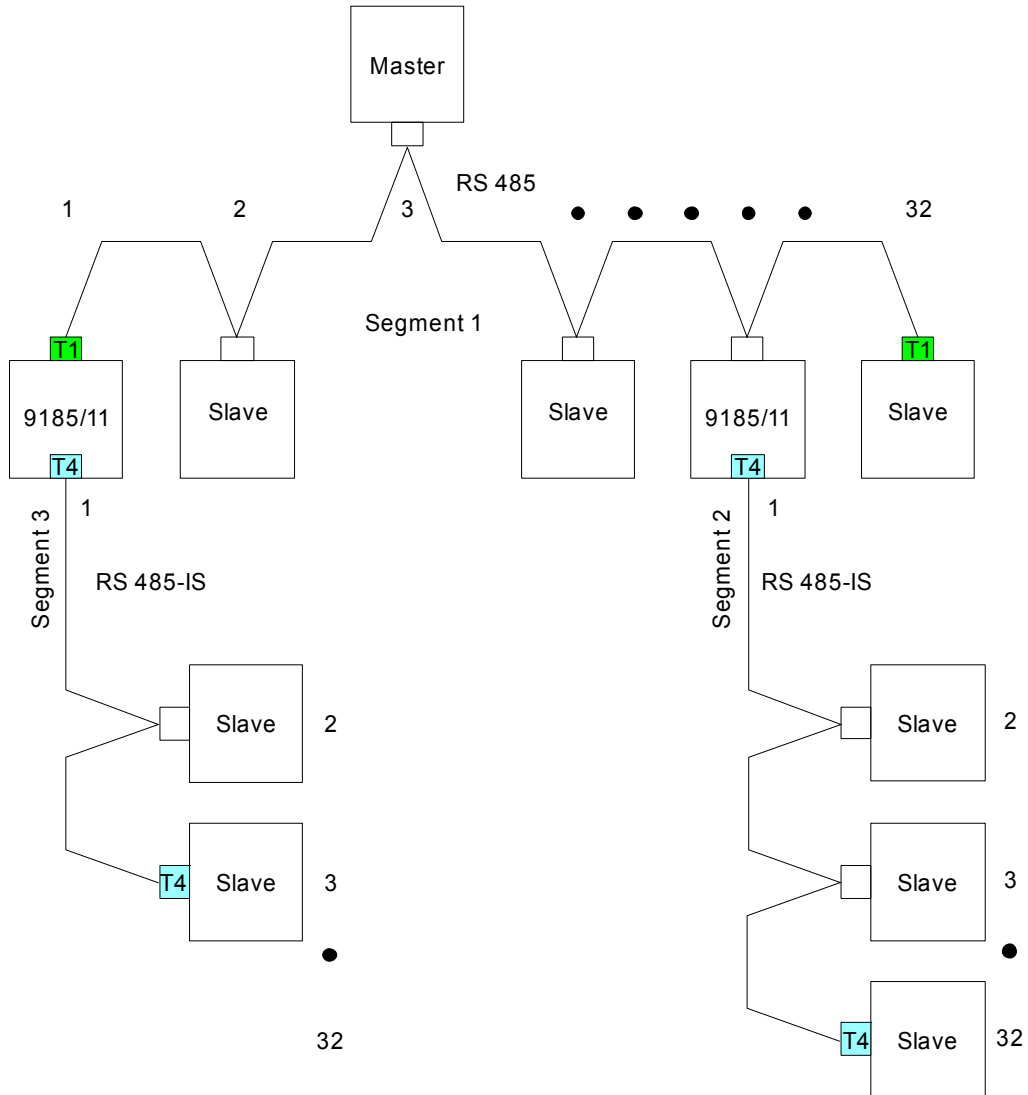

Fig 1 RS 485-IS conform to the PNO specification with fieldbus isolating repeater type 9185

Figure 1 shows the intrinsically safe RS 485-IS bus in accordance with PNO Guideline 2262. UART protocols, such as Profibus DP, Modbus, RS 485 HART or the Servicebus of R. STAHL, are used as the protocol. In this example, the 9185/11 fieldbus isolating repeater is set to RS 485-IS. Unlike in Figures 2 and 3, up to 32 field bus devices are possible on the intrinsically safe bus segments in the case of an installation conform to RS 485-IS. The 9185 fieldbus isolating repeater is a true repeater, unlike its predecessor model 9373/21, and allows cascading of several devices (see Fig 4).

The number of fieldbus devices which can be connected to a network is limited by the address space of the bus protocol used (see 4.7). The RS 485 interface limits the number of fieldbus devices per physical segment to 32 (all devices connected to the segment, such as master, slaves, repeaters and isolating repeaters etc. count as fieldbus devices.). If more than 32 fieldbus devices are used in a network, repeaters must be provided for further physical segments.

	Description, bus terminating resistor	Ordering code
T1	Sub-D connector standard RS 485, non Ex and Zone 2	105715
T4	Sub-D connector for Zone 1 CPM, in accordance with RS 485-IS	94 900 02 22 0

Project planning, installation and commissioning of the RS 485 field bus system of R. STAHL for the safe and hazardous area

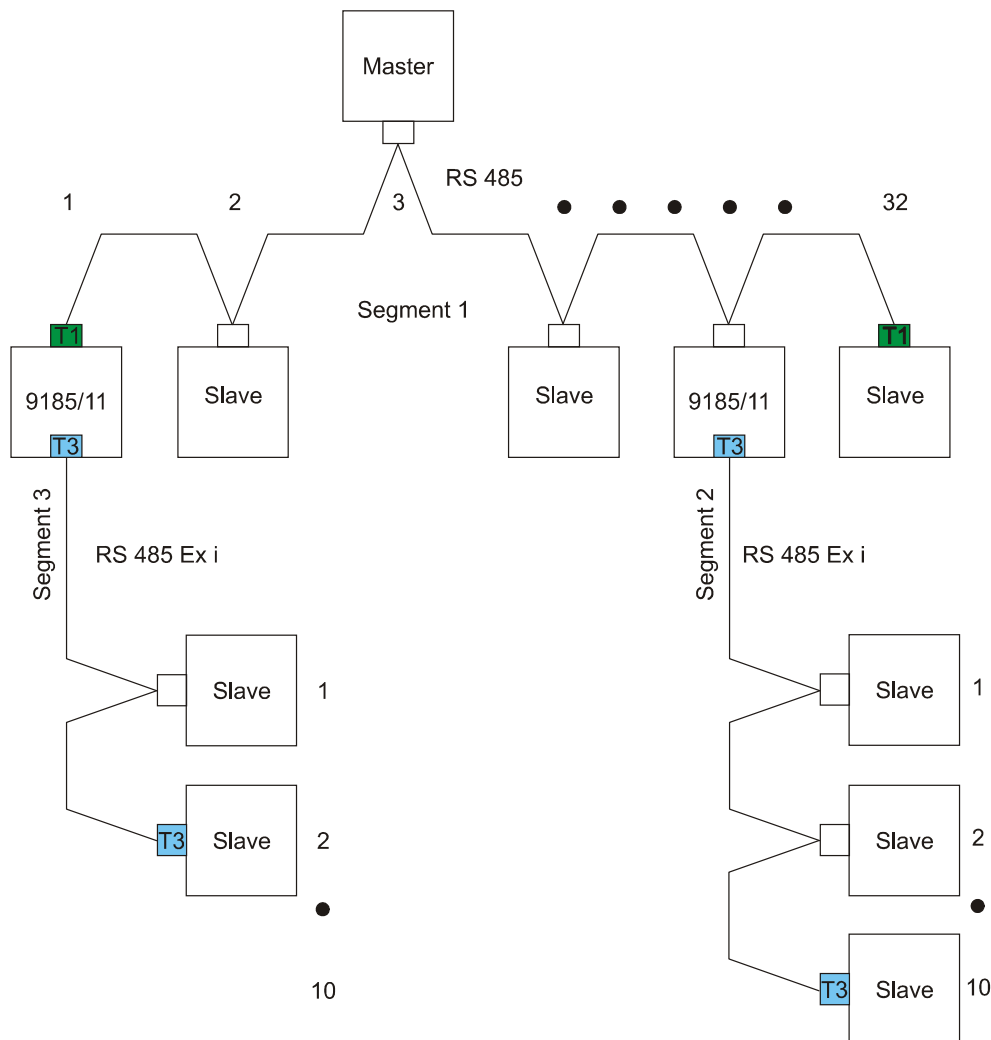

Fig 2 RS 485 Ex i conform to the R. STAHL specification with fieldbus isolating repeater type 9185

Figure 2 shows the principle structure of an RS 485 bus system with intrinsically safe RS 485 Ex i segments in accordance with R. STAHL specification and the bus terminating resistors to be installed. UART protocols, such as Profibus DP, Modbus, RS 485 HART or the Servicebus of R. STAHL, are used as the protocol. In this example, the 9185/11 fieldbus isolating repeater is set to RS 485 Ex i, in accordance with the R. STAHL specification. Furthermore, the Sub-D connector type type 94 900 03 22 0 must be used.

The number of fieldbus devices which can be connected to a network is limited by the address space of the bus protocol used (see 4.7). The RS 485 interface limits the number of fieldbus devices per physical segment to 32 (11 Ex i) (all devices connected to the segment, such as master, slaves, repeaters and isolating repeaters etc. connected to the segment are considered as fieldbus devices). If more than 32 fieldbus devices are used in a network, repeaters or isolating repeaters must be provided for further physical segments. Segment 1 is extended via 2 fieldbus isolating repeaters, Type 9185/11, with 2 intrinsically safe physical segments (2 and 3). The maximum number of fieldbus devices in an intrinsically safe segment in accordance with R. STAHL specification is 11.

	Description, bus terminating resistor	Ordering code
T1	Sub-D connector standard RS 485, non Ex and Zone 2	105715
T3	Sub-D connector for Zone 1 CPM, in accordance with RS 485 Ex i	94 900 03 22 0

Project planning, installation and commissioning of the RS 485 field bus system of R. STAHL for the safe and hazardous area

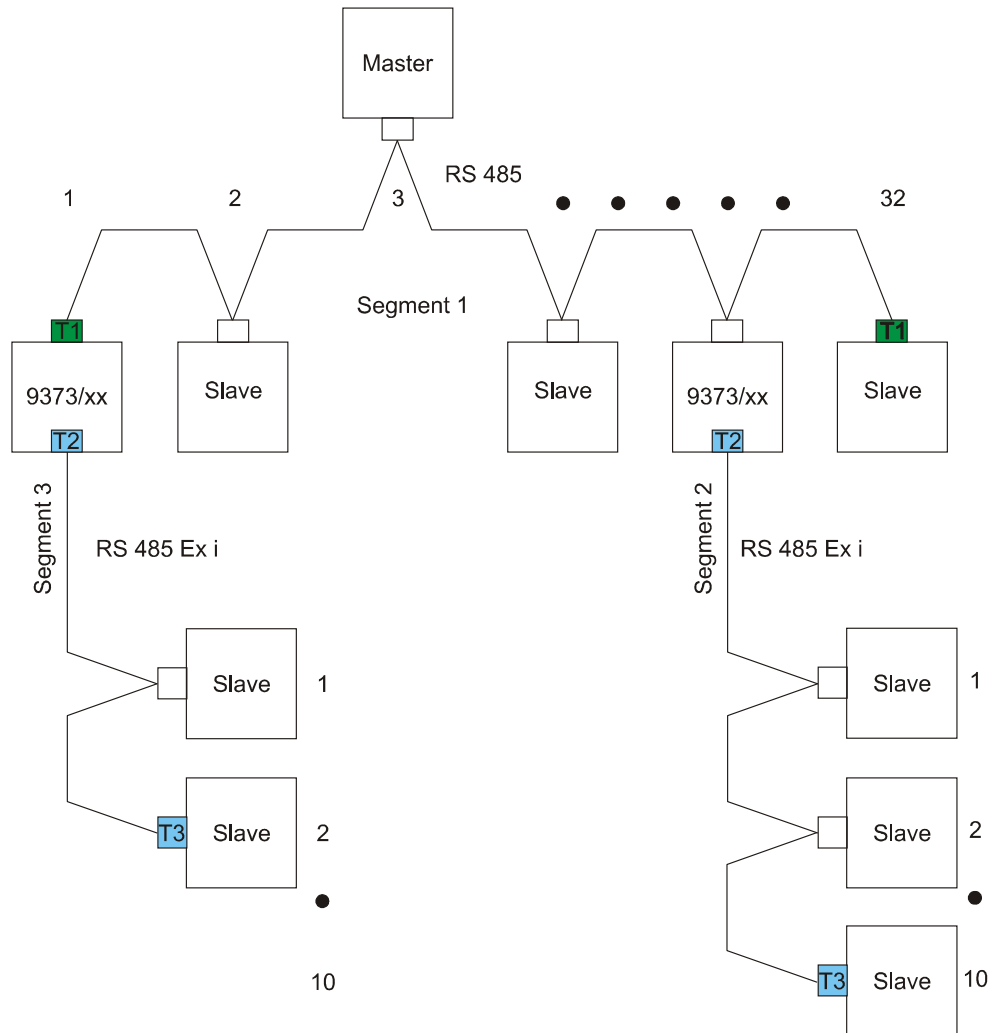

Fig 3 RS 485 Ex i conform to the R. STAHL specification with fieldbus isolating repeater type 9373

Figure 3 shows the basic structure of an RS 485 bus system with intrinsically safe RS 485 Ex i segments in accordance with R. STAHL specification and the bus terminating resistors to be installed when type 9373/xx fieldbus isolating repeaters are used. UART protocols, such as Profibus DP, Modbus, RS 485 HART or the Servicebus of R. STAHL, are used as the protocol.

The number of fieldbus devices which can be connected to a network is limited by the address space of the bus protocol used (see 4.7). The RS 485 interface limits the number of fieldbus devices per physical segment to 32 (11 Ex i) (all devices connected to the segment, such as master, slaves, repeaters and isolating repeaters etc. connected to the segment are considered as fieldbus devices). If more than 32 fieldbus devices are used in a network, repeaters or isolating repeaters must be provided for further physical segments. In Figure 1, segment 1 is extended via 2 fieldbus isolating repeaters with 2 physical segments (2 and 3). The maximum number of fieldbus devices in an intrinsically safe segment in accordance with R. STAHL specification is 11.

	Description, bus terminating resistor	Ordering code
T1	Sub-D connector standard RS 485 non Ex and Zone 2	105715
T2	Internal bus terminating resistor + 470 Ohm at terminals	
T3	Sub-D connector for Zone 1 CPM, in accordance with RS 485 Ex i	94 900 03 22 0

Not for use in new installations!



Operating Instructions

Project planning, installation and commissioning of the RS 485 field bus system of R. STAHL for the safe and hazardous area

4.3. Upgrade from RS 485 Ex i to RS 485-IS Installation

When upgrading an old installation according to RS 485 Ex i (according to STAHL specification) with CPMs type 9440/12 and 9373/21 to the new PNO specification RS 485-IS the following topics shall be accomplished.

1. The interface use towards the DCS (Profibus, Modbus) shall always be treated as one system. This mean all components connected to the Bus shall be changed at the same time.
 - a. Fieldbus-isolating repeater 9185/11-35-10
 - i. The DIP switch PNO set to ON
 - ii. Sub D-connector for zone 1 CPM, according to RS 485-IS
STAHL order-no. 94 900 02 22 0 or
Sub D-connector for zone 1, 45° version according to RS 485-IS
STAHL order-no. 201805
 - b. Exchange CPM with type 9440/22 and the socket type 9490/11-12
 - i. Sub D-connector for zone 1 CPM, according to RS 485-IS
STAHL order-no. 94 900 02 22 0
 - c. The profibus cable type A may be used for the new installation.
2. With the servicebus interface the components used may be replace partially. This allows a transition between RS 485 Ex i and RS 485-IS. For the servicebus often several IS 1 stations where to the same servicebus but to different DCS busses. If not all IS1 stations are upgraded at the same time it is allowed to operated CPMs with an RS 485 Ex i and RS485-IS interface at the same physical link. To do so the following rules shall be observed.
 - a. Fieldbus-isolating repeater 9185/11-35-10
 - i. The DIP switch PNO set to OFF
 - ii. Sub D-connector for zone 1 CPM, according to RS 485-IS
STAHL order-no. 94 900 02 22 0 or
Sub D-connector for zone 1, 45° version according to RS 485-IS
STAHL order-no. 201805
 - b. The replacement of CPM and socket has to be started at the end of the bus segment (the opposite site of the DCS connection).
 - c. In parallel to the CPM replacement the Sub-D connector shall be replaced by Sub D-connector for zone 1 CPM, according to RS 485-IS STAHL order-no. 94 900 02 22 0.
 - d. The last Sub-D connector (Bus terminator) will remain until the complete physical bus segment is upgraded, Sub-D connector for Zone 1 CPM, in accordance with RS 485 Ex i 94 900 03 22 0.
 - e. After the upgrade or all component at the bus was done the last thing to do change the last Sub-D connector to Sub D-connector for zone 1 CPM, according to RS 485-IS STAHL order-no. 94 900 02 22 0 and set the DIP switch PNO at the 9185/11-35-10 to ON.



Project planning, installation and commissioning of the RS 485 field bus system of R. STAHL for the safe and hazardous area

4.4. Usable components

Intrinsically safe RS 485 bus segment	
In accordance with RS485-IS (PNO Specification)	In accordance with RS 485 Ex i (R. Stahl specification)
<ul style="list-style-type: none"> • Only devices in accordance with 'PROFIBUS RS485 IS' specification may be connected to a bus segment. 	<ul style="list-style-type: none"> • Only devices in accordance with 'R. Stahl specification RS 485 Ex i' may be connected to a bus segment.
<ul style="list-style-type: none"> • A mix of devices with differing specifications is not permitted unless this is expressly allowed. 	
<ul style="list-style-type: none"> • CPM, Type 9440/22 • Fieldbus isolating repeater, Type 9185/11 • Fieldbus isolating repeater, fibre-optic Type 9372/11-21-30 *1) • Sub-D connector for RS 485-IS Order code 94 900 02 22 0 	<ul style="list-style-type: none"> • CPM, Type 9440/12 • Fieldbus isolating repeater, Type 9373/21 • Fieldbus isolating repeater fibre-optic Type 9372/11-21-30 • Fieldbus isolating repeater fibre-optic Type 9372/11-21-20 • Sub-D-connector for RS 485 Ex i Order code 94 900 03 22 0
<p>Warning! Standard PROFIBUS connectors must not be used in an intrinsically safe bus segment.</p>	

*1) Length of the intrinsically safe bus maximum 100 m with maximum 5 fieldbus devices. Activation of the terminating resistor on the 9372 and deactivation in the Sub-D connector.

4.5. Bus length RS 485, RS 485-IS and RS 485 Ex i

Transmission speed	Max. sum of the lengths of stub lines per segment *1)	Max. length of a bus segment if using standard PROFIBUS cable (Type A) see Chapter 3.7
9.6 to 93.75 kbit/s	96 m	1,200 m
187.5 kbit/s	75 m	1,000 m
500 kbit/s	30 m	400 m
1.5 Mbit/s	10 m	200 m

*1) Stub lines along the bus should be avoided. Stub lines are generally implicitly present (e.g. the internal connection lines from the Sub-D connector to the chip generally amount to up to 20 cm per device). These are a part of the stub line length. The minimum distance between two fieldbus devices should not be less than 2 m on average so as to avoid an accumulation of the connection capacitance at one position. If stub lines/branch lines are required, they should be physically separated for the continuous bus segments by means of a repeater so as to avoid interference as the result of mismatch.

Project planning, installation and commissioning of the RS 485 field bus system of R. STAHL for the safe and hazardous area

4.6. Extending the network structure

If the maximum segment length will be exceeded at a given transmission speed, the bus segment must be extended by means of a repeater or the planned transmission speed must be reduced accordingly.

4.7. Address space of the bus protocols

Protocol	Software	Address space
Profibus DP	----	0 to 124
Modbus RTU	----	0 to 127
Servicebus	I.S. Wizard	0 to 127
HART RS 485	AMS, Emerson	0 to 127
HART RS 485	Cornerstone, ASTEC	0 to 127
HART RS 485	HART Server, HCF	0 to 31
HART RS 485	PDM, Siemens	0 to 31
HART RS 485	H-FDCM, Honeywell	0 to 127
HART RS 485	PRM ,Yokogawa	0 to 31

The bus protocols used must be taken into consideration when assigning addresses to the individual fieldbus devices. If a system is planned with, for instance, 20 Profibus networks and, in parallel with this, a Servicebus network for HART and diagnostic purposes, coordination between the two networks will be required for address assignment. If, for instance, 10 fieldbus devices (I.S. 1 Remote I/O) are present per Profibus network, the addresses should not be set from 1 to 10 per network since the same addresses will be used on the Profibus as are used on the Servicebus. The Servicebus will normally be installed beyond several Profibus segments and this means that several I.S. 1 stations with the same addresses occur on the Servicebus. In order to avoid this, the addresses should be assigned consecutively, e.g. to 10, 11 to 20 and 21 to 30...

4.8. Number of fieldbus devices of an RS 485 segment

32 users may be connected per bus segment. Masters, slaves, repeaters and isolating repeaters as well as all physical bus connections connected to the respective bus segment count as fieldbus devices.

4.9. Number of fieldbus devices of an intrinsically safe RS 485-IS or RS 485 Ex i bus segment

If using a RS 485-IS conform to the PNO guideline, 32 fieldbus devices (slaves, repeaters, masters, etc.) are allowed per intrinsically safe bus segment. If a fiber optic fieldbus isolating repeater type 9372/11-21-30 is used as an isolator, a maximum of 5 fieldbus devices on a maximum 100 m fieldbus length are permissible.

If using an RS 485 Ex i bus in accordance with R. STAHL specification, 10 field bus devices and one field bus isolating repeater are allowed per intrinsically safe bus segment for functional reasons.

Project planning, installation and commissioning of the RS 485 field bus system of R. STAHL for the safe and hazardous area

4.10. Fieldbus cable

4.10.1. RS 485-IS conform to PNO specification and RS 485 Ex i conform to R. STAHL specification

Functional technical data	
Characteristic impedance	approx. 150 Ohm (135-165 Ohm)
Loop resistance	< 110 Ohm/km at 25 °C
Effective capacitance	< 30 nF/km
Sheath material and colour	In accordance with customer's requirements
Safety relevant technical data	
(all data must be observed at ambient temperatures from -40 °C to +70 °C)	
Loop resistance	82 Ohm/km to 372 Ohm/km
L/R ratio	≤ 15µH/Ohm
Effective capacitance C'	≤ 250 nF/km
Stranded wire diameter*)	≥ 0.1 mm

*) splice protection should be used with fine stranded wires

The working inductance or L/R ratio is normally not specified by the cable manufacturers since it is of subordinate importance as regards the operating behaviour. This parameter is necessary for technical safety considerations of the intrinsically safe RS 485 Ex i/RS 485-IS bus. The values listed in the tables must be specified by the respective cable manufacturer. The cables supplied by R. STAHL comply with these values.

This data describes the standard Profibus cable, Type A, for RS 485. This cable is available in a very wide variety of mechanical designs. The cables are coloured for laying indoors, laying outdoors and laying underground (violet or black). A light blue cable is used for intrinsically safe circuits for colour coding.

4.10.2. Cables available as standard from R. STAHL

Standard coded cabling	Material/colour	R. STAHL ordering code
02Y(ST)CY2Y 1x2x0.64/2.55-150 SW, for laying outdoors	PE/PVC, black/violet	105444
02YS(ST)CY2Y 1x2x0.64/2,55-150 VI, for laying indoors	PVC, violet	105438
02YS(ST)CY2Y 1x2x0.64/2,55-150 BL, for laying indoors	PVC, blue	105437
02YS(ST)CHSH 1x2x0,64; flame retardant, steel wire mesh armored cable, e.g. for offshore installation	halogen-free, blue	105400
02YS(ST)CHSH 1x2x0,64; flame retardant, steel wire mesh armored cable, e.g. for offshore installation	halogen-free, violet	209430

The cable supplied by R. STAHL can be used for the intrinsically safe RS 485-IS or RS 485 Ex i fieldbus as well as for the standard RS 485 fieldbus.

4.11. Proof of intrinsic safety of a fieldbus installation

1. RS 485-IS is conform with the PNO specification on the basis of the system certificate
2. RS 485 Ex i is conform with the R. STAHL specification on the basis of the system certificate
3. RS 485-IS is conform with the PNO specification on the basis of EN 60 079-11, -25

Project planning, installation and commissioning of the RS 485 field bus system of R. STAHL for the safe and hazardous area

4.11.1. Proof of intrinsic safety of a fieldbus installation conform to RS 485-IS on the basis of the PTB 04 ATEX 2089, 1. Supplement system certificate

Conform to RS 485-IS the fieldbus devices can be connected with the maximum values

$U_o = \pm 4.2 \text{ V}$ and $I_o = \pm 149 \text{ mA}$ with a linear source

characteristic.

The total current of all field devices on the RS 485-IS bus may not exceed $\pm 4.8 \text{ A}$.

Fieldbus devices	U_o	I_o	U_i	C_i and L_i
9440/22-01-21	$\pm 3.7 \text{ V}$	$\pm 134 \text{ mA}$	$\pm 4.2 \text{ V}$	0
9440/22-01-11	$\pm 3.7 \text{ V}$	$\pm 134 \text{ mA}$	$\pm 4.2 \text{ V}$	0
9185/11-35-10	$\pm 3.73 \text{ V}$	$\pm 149 \text{ mA}$	$\pm 4.2 \text{ V}$	0

The technical safety related output voltage of all fieldbus devices is $U_o < \pm 4.2 \text{ V}$.

The maximum current of a fieldbus device is 149 mA, which results in the following maximum number of devices on a physical bus segment:

$$n = \frac{\sum I}{I_{\text{Max_devices}}} = \frac{4.8 \text{ A}}{0.149 \text{ A}} = 32.2 \approx 32 = n$$

The maximum number of field devices on the bus may be less for functional reasons than the number stated for technical safety limitation reasons, see 4.9.

A cable conform to the specifications in 4.10.1 must be used as a field bus cable. No concentrated capacitances or inductances are permitted along the fieldbus.

The Sub-D connector type 94 900 02 22 0 supplied by R. STAHL are approved for use within the RS 485-IS intrinsically safe fieldbus for an ambient temperature of $-40 \text{ }^\circ\text{C}$ to $+70 \text{ }^\circ\text{C}$.

A minimum fieldbus length between two field devices must be observed when installing the fieldbus system:

Number of field devices	Fieldbus length
< 16	> 0 m
> 16	> 1 m

The fieldbus system must be marked as follows at least once in the vicinity of the start of the fieldbus. The marking label is provided with the Sub-D connectors.





Project planning, installation and commissioning of the RS 485 field bus system of R. STAHL for the safe and hazardous area

4.11.2. Proof of intrinsic safety of a fieldbus installation conform to RS 485 Ex i on the basis of the PTB 04 ATEX 2089 system certificate

Conform to RS 485 Ex i the fieldbus devices can be connected with the maximum values

$U_o = \pm 3.75 \text{ V}$ with a linear source characteristic.

The total current of all field devices on the RS 485 Ex i bus must not exceed $\pm 2.25 \text{ A}$.

Fieldbus device	U_o	I_o	U_i	C_i and L_i
9440/12-01-11	$\pm 3.72 \text{ V}$	$\pm 107 \text{ mA}$	$\pm 3.75 \text{ V}$	0
9185/11-35-10	$\pm 3.73 \text{ V}$	$\pm 149 \text{ mA}$	$\pm 4.2 \text{ V}$	0
9372/11-21-20	$\pm 3.72 \text{ V}$	$\pm 184 \text{ mA}$	$\pm 3.75 \text{ V}$	0
9372/11-21-30	$\pm 3.72 \text{ V}$	$\pm 184 \text{ mA}$	$\pm 4.2 \text{ V}$	0

The technical safety related output voltage of all fieldbus devices is $U_o < \pm 3.75 \text{ V}$.

The maximum current of a fieldbus device is 184 mA, which results in the following maximum number of devices on a physical bus segment:

$$n = \frac{\sum I}{I_{\text{Max_devices}}} = \frac{2.25 \text{ A}}{0.184 \text{ A}} = 12.2 \approx 12 = n$$

The maximum number of field devices on the bus may be less for functional reasons than the number stated for technical safety limitation reasons (see 4.9).

A cable conform to the specifications in 4.10.1 must be used as a field bus cable. No concentrated capacitances or inductances are permitted along the fieldbus.

The Sub-D connector type 94 900 03 22 0 supplied by R. STAHL are approved for use within the RS 485 Ex i intrinsically safe fieldbus for an ambient temperature of $-40 \text{ }^\circ\text{C}$ to $+70 \text{ }^\circ\text{C}$.

The fieldbus system must be marked as follows at least once in the vicinity of the start of the fieldbus. The marking label is provided with the Sub-D connectors.



Project planning, installation and commissioning of the RS 485 field bus system of R. STAHL for the safe and hazardous area

4.11.3. Proof of intrinsic safety of an installation conform to EN 60 079-11 for RS 485-IS and RS 485 Ex i

In accordance with EN 60 079-11:2012, Chapter 6.2.3, the maximum, external inductance-resistance ratio L_o/R_o for a source with ohmic current limiting can be determined on the basis of its maximum values U_o and I_o . The maximum permitted capacitance is determined from the minimum ignition curves.

The fieldbus devices of R. STAHL approved for the RS 485-IS and RS 485 Ex i fieldbus, such as 9440/22.., 9440/12.., 9185/11.. and 9372/11.., are certified as single devices with the following maximum values or less in accordance with ATEX.

Fieldbus device	U_o	I_o	U_i	C_i and L_i
9440/12-01-11	± 3.72 V	± 107 mA	± 3.75 V	0
9440/22-01-..	± 3.73 V	± 149 mA	± 4.2 V	0
9185/11-35-10	± 3.73 V	± 149 mA	± 4.2 V	0
9372/11-21-20	± 3.72 V	± 184 mA	± 3.75 V	0
9372/11-21-30	± 3.72 V	± 184 mA	± 4.2 V	0

The technical safety related output voltage of all fieldbus devices is $U_o < I_{\pm 3.75} V$. This is permissible from a technical safety viewpoint as the minimum $U_i = \pm 3.75$ V.

Formula for $L_i = 0$:

$$\frac{L_o}{R_o} = \frac{32 * e * R_i}{9 * U_o^2} \quad e = 40 \mu J \text{ for IIC}$$

The calculation is based on 15 fieldbus devices, i.e. 14 I.S. 1 field stations and one fieldbus isolating repeater, type 9372/11, can be connected. The maximum number of field devices on the bus may be less for functional reasons than the number stated for technical safety limitation reasons (see 4.9).

The calculation considers the use of a 9372/11, this can also be replaced by a 9185/11. In addition, it is allowed to use further 9185/11 to replace field stations owing to the fact that the I_o value is the same.

Fieldbus devices according to RS 485 Exi or RS 485-IS must be kept on separate field busses due to functional reasons see chap. 4.



Project planning, installation and commissioning of the RS 485 field bus system of R. STAHL for the safe and hazardous area

A distinction is made between two cases as regards calculation:

- a. All fieldbus devices have the same priority:

$$U_o = 3.75 \text{ V}$$

$$I_o = \Sigma I_o = 14 * 149 \text{ mA} + 184 \text{ mA} = 2270 \text{ mA}$$

$$R_i = \frac{U_o}{I_o} = \frac{3.75 \text{ V}}{2270 \text{ mA}} = 1.65 \text{ Ohm}$$

- b. Half of the fieldbus devices have positive polarity and half of them have negative polarity:

$$U_o = 2 * 3.75 \text{ V} = 7.5 \text{ V}$$

$$I_o = \Sigma \frac{I_o}{2} = 7 * 149 \text{ mA} + 184 \text{ mA} = 1227 \text{ mA}$$

$$R_i = \frac{U_o}{I_o} = \frac{7.5 \text{ V}}{1227 \text{ mA}} = 6.11 \text{ Ohm}$$

The values are as follows, substituted in the formula above:

Cas e	U _o	R _i	L _o /R _o allowed		L _o /R _o cable	
a.	3.75 V	1.65 Ohm	16.68 μH/Ohm	>	15 μH/Ohm	OK
b.	7.5 V	6.11 Ohm	15.44 μH/Ohm	>	15 μH/Ohm	OK

The permitted capacitance for U_o < 10 V is 3 μF for IIC. This is sufficient at 30 nF/km with a maximum fieldbus segment length of 1200 m.

The permitted total current I_o for voltages U_o < 12 V is 3.33A. => I_{o RS485-IS} < I_{o permitted}

Project planning, installation and commissioning of the RS 485 field bus system of R. STAHL for the safe and hazardous area

4.12. Maximum number of series-connected repeaters

The number of repeaters which can be connected in series depends on manufacturer. Repeaters allow a bus segment to be extended (e.g. at 1.5 Mbit/s, the max. segment length is limited to 200 m; if a repeater is fitted, the segment length is extended by a further 200 m).

The fieldbus isolating repeaters, type 9373/21, are designed for isolation between the safe area and the hazardous area. They cannot be used as repeaters. As shown in Fig 3, a fieldbus isolating repeater is connected in the safe area to an RS 485 segment, thus opening up one RS 485 Ex i segment in each case. It is not permitted to extend the RS 485 Ex i segment.

The fieldbus isolating repeaters, type 9185, also perform the function of a repeater, in addition to the function of the 9373/21 and, thus, these units can be used as conventional repeaters in an RS 485 bus segment to extend a bus segment. The maximum number of series-connected fieldbus isolating repeaters, type 9185, is limited to 4 without cable redundancy and to 2 with cable redundancy between any two fieldbus devices.

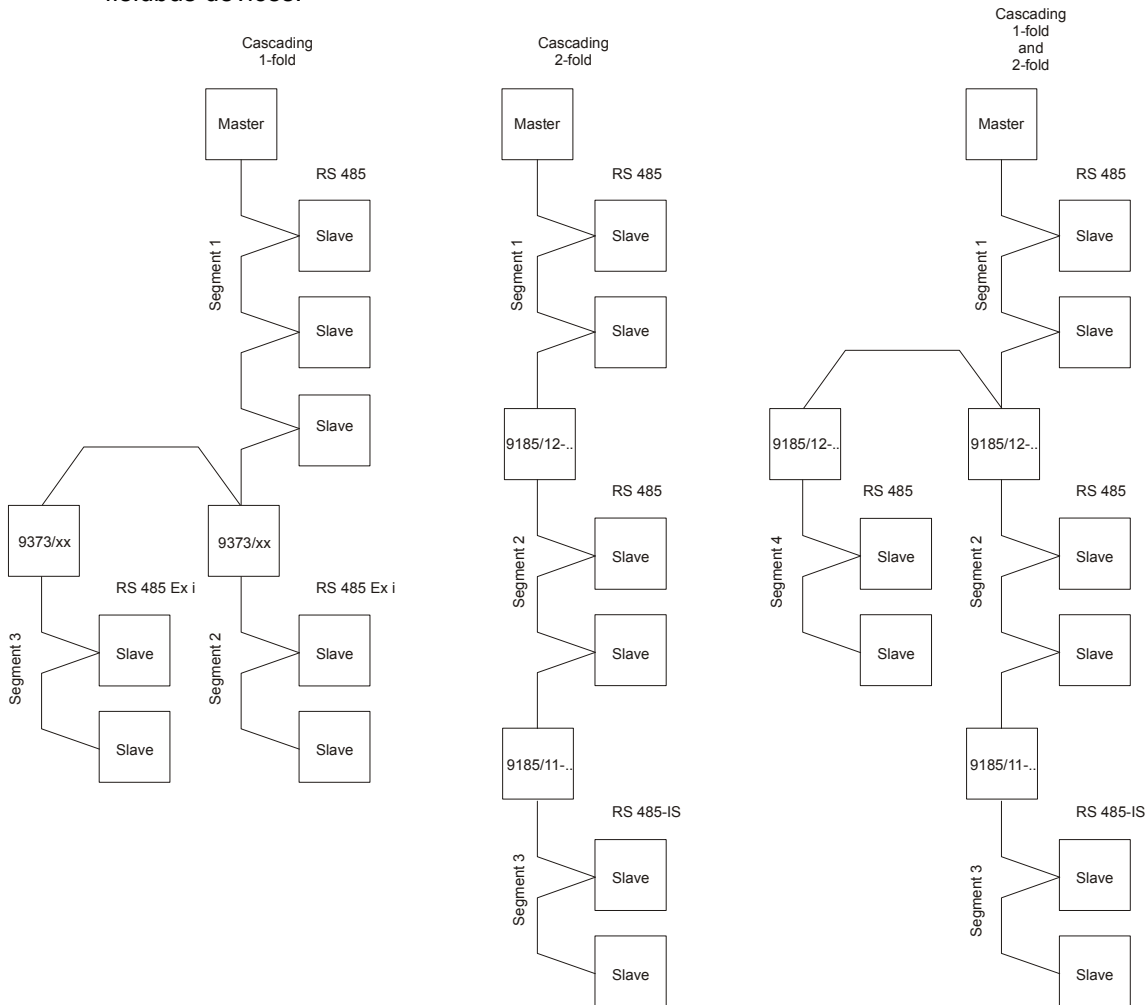





Fig 4: The illustration on the left indicates single cascading. There is a maximum of 1 type 9373/21... isolating repeater between the master and any slave. The illustration in the centre indicates double cascading. Two type 9185/.. fieldbus isolating repeaters are arranged between the master and the most distant slave. The right-hand illustration shows a combination of the two others.

Project planning, installation and commissioning of the RS 485 field bus system of R. STAHL for the safe and hazardous area

4.13. Sub-D connector for the fieldbus

Only Sub-D connectors approved by R. STAHL may be employed for the intrinsically safe segment of the fieldbus. The connectors are provided with a connection for an incoming and an outgoing cable.

The terminating resistors are integrated into the Sub-D connectors from R. STAHL. The devices supplied by R. STAHL feature two power supply pins for powering the terminating resistor in parallel with the two data line pins. The terminating resistor can be connected by means of a switch in the Sub-D connector. The outgoing bus cable is disconnected from the field bus if the bus termination is activated. The Sub D connector type used depends on the fieldbus device used and the bus specification, and is described in section 4.2.3 and 0.

Description, Bus Terminator	Order number	
Sub D-connector standard RS 485, none Ex and Zone 2	105715	
Sub D-connector for zone 1 CPM, according to RS 485 Ex I Ex i conform to R. STAHL specification, 120 ohms	94 900 03 22 0	
Sub D-connector for zone 1 CPM, according to RS 485-IS conform to PNO Specification, 200 ohms	94 900 02 22 0	
Sub D-connector for zone 1, 45° version according to RS 485-IS	201805	

Project planning, installation and commissioning of the RS 485 field bus system of R. STAHL for the safe and hazardous area

4.14. Additional terminating resistors for the RS 485 Ex i fieldbus according to the R.STAHL specification when type 9373/21 or 9372/.. fieldbus isolating repeaters are used

The powered terminating resistor of the RS 485 Ex i fieldbus segment fitted in the fieldbus isolating repeater is supplemented with an external 470 ohm resistor Fig 5 and Fig 6 (This resistor is crimped with crimp ferrules together with the wires of the fieldbus cable into the fieldbus isolating repeater. A Sub-D connector supplied by R. STAHL, with integrated, switch-in 120 Ohm terminating resistor, is used at the end of the bus.

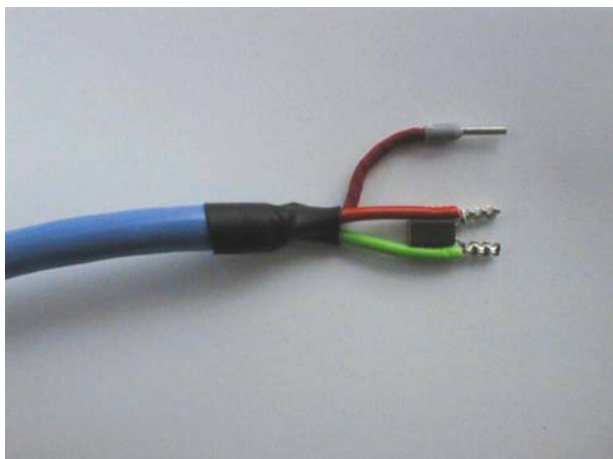

Fig 5 external 470 Ohm resistor

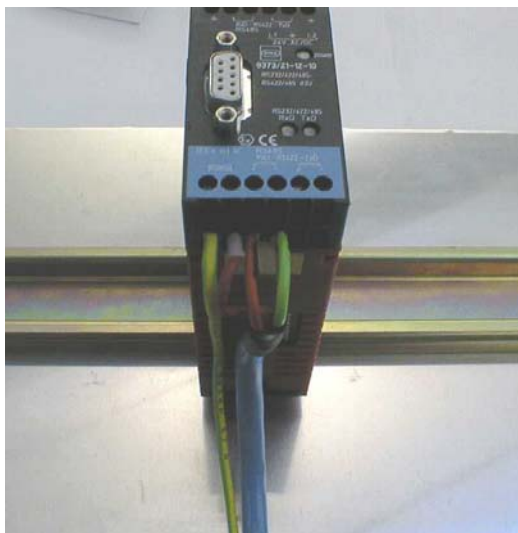

Fig 6 Connection of the external resistor

RS 485 Ex i, 470 Ohm resistor for connection to terminals 9373/21 and 9372/..	Order code 642 716 0
---	----------------------

Project planning, installation and commissioning of the RS 485 field bus system of R. STAHL for the safe and hazardous area

4.15. Earthing of the conductive shielding of an intrinsically safe fieldbus

The fieldbus construction selected by R. STAHL complies with EN 60 079-14:2008 12.2.2.3, Section b). This essentially relates to the option of earthing the shielding of the fieldbus at various points.

Excerpt from EN 60 079-14:2008 12.2.2.3, Section b

If the installation is made and maintained in such a way that it can be ensured, with a high degree of certainty, that equipotential bonding exists between each end of the circuit (i.e. between the hazardous and non-hazardous areas), then - if desired - cable shielding and conductor shielding at both ends of the cable and the conductor at intermediate points may be connected to earth if necessary.

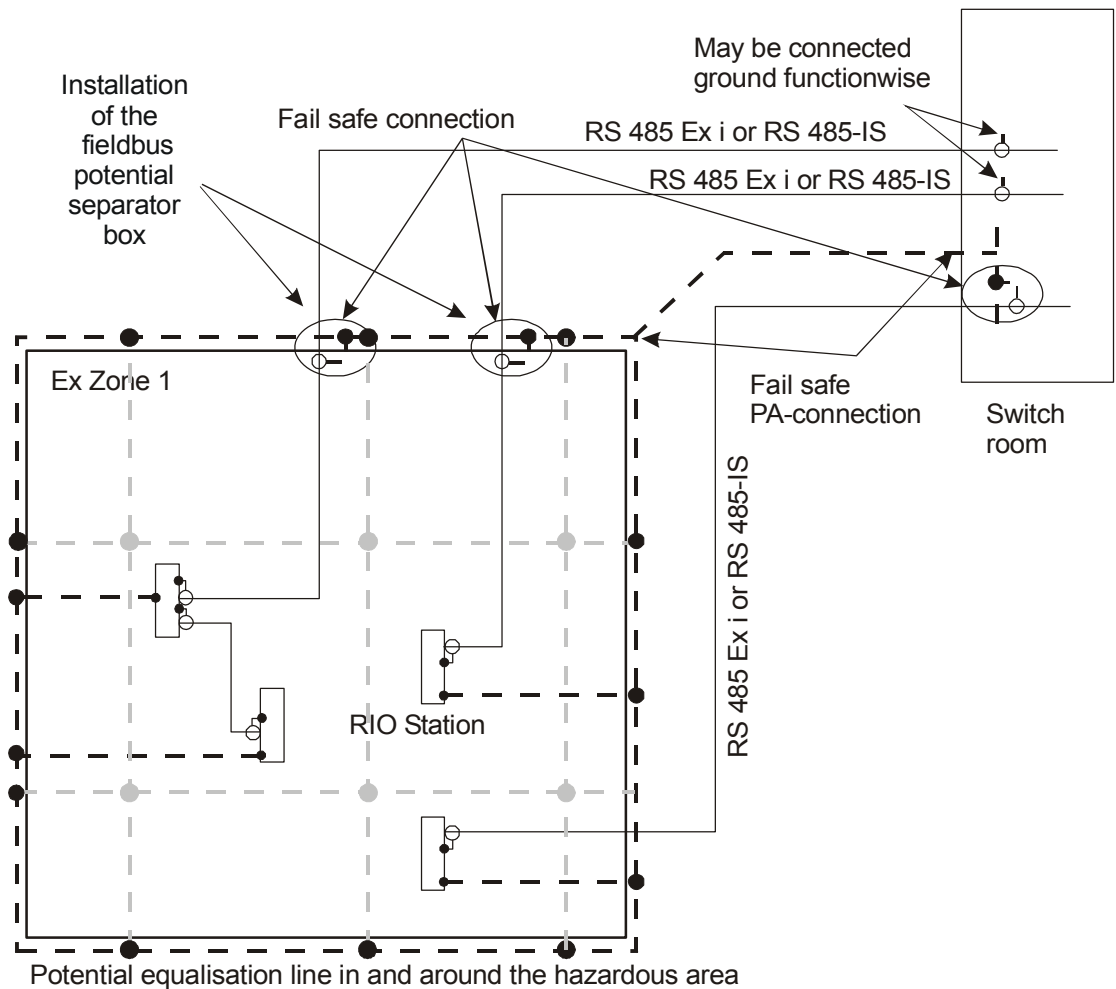

Fig 7 Earthing of a conductive shield

The example in Fig 7 shows one possible structure of a system, in accordance with the requirement of EN 60 079-14:2008 12.2.2.3, Section b).

Project planning, installation and commissioning of the RS 485 field bus system of R. STAHL for the safe and hazardous area

1. The shielding of the RS 485-IS or RS 485 Ex i bus must be connected in a fail-safe manner to the equipotential bonding line at the crossover between the non-hazardous area and Zone 1.
2. The equipotential bonding line is led, fail-safe and with sufficient cross-sectional area, to the switch compartment. This allows the realization of a fail-safe type connection of the shield in the switching compartment.

The fail-safe equipotential bonding connection of the conductive shielding before the hazardous area means that no incendive currents or voltages are admitted into the hazardous area.

Within the hazardous area, the equipotential bonding system ensures a constantly good earth connection of all installed systems. The individual I.S. 1 field enclosures must be included in the equipotential bonding system in accordance with valid regulations. The cross-section of the earthing conductor depends on local conditions, such as cross-section of the power supply and surrounding metallic construction parts.

The conductive shielding of the incoming and outgoing fieldbus cable is connected via suitable terminals (generally an Ex e terminal) to the shielding busbar in the I.S. 1 field enclosure. The shielding busbar itself is connected to the equipotential bonding system.

If there are doubts in respect of the effectiveness of the equipotential bonding system, an equipotential bonding conductor with an adequate cross-section must be laid in parallel with the field bus cable. The aim of the equipotential bonding conductor is to avoid or limit current flow on the shielding.

4.16. Design of safe isolation of the fieldbus cable shielding

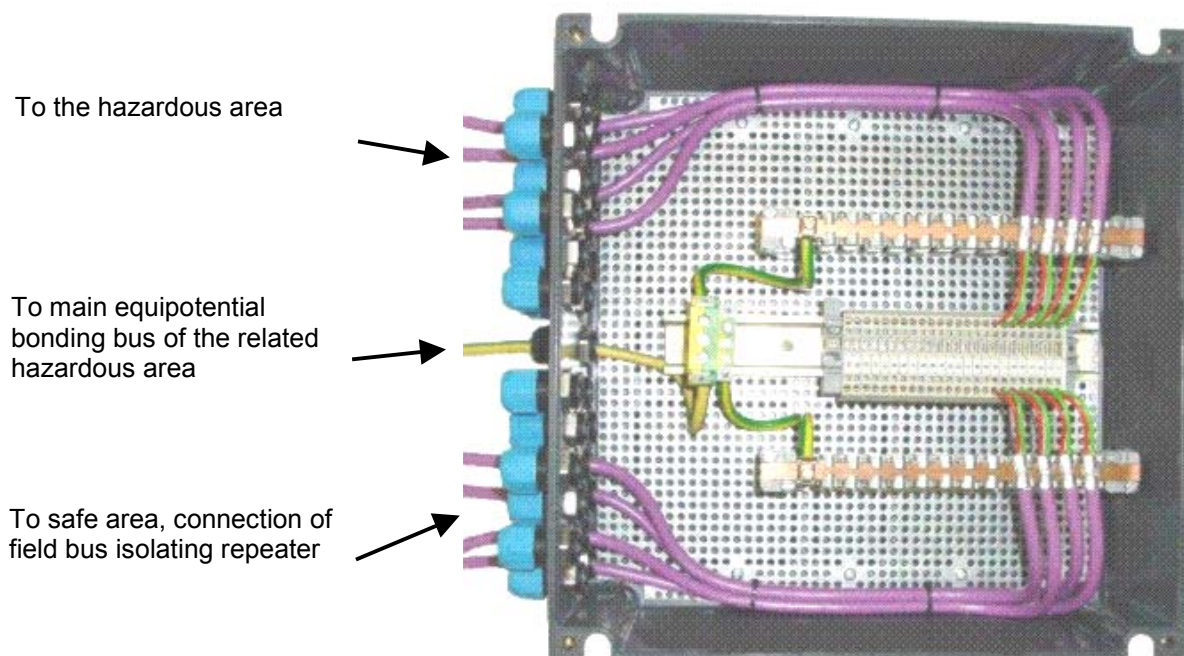

Fig 8 Example of a fieldbus potential isolating box

The fieldbus potential isolating box ensures a neat and safe connection of the fieldbus cable shielding to the equipotential bonding system of the related hazardous area. The equipotential bonding connection is routed to the main equipotential bonding bus of the related hazardous area.

Project planning, installation and commissioning of the RS 485 field bus system of R. STAHL for the safe and hazardous area

5. Installation

5.1. Important information on installation and project planning rules

The great majority of problems that occur during commissioning of an RS 485 bus system, e.g. Profibus DP or Modbus, are installation problems, such as:

- wrong field bus cables,
 - badly connected plug and socket connectors,
 - open circuit or short circuit and
 - missing terminating resistors or too many of them.
- These faults account for about 90 % of all commissioning problems.
 - The remaining 10 % are split between configuration errors and equipment faults.

To counter this state of affairs, attention must be paid during installation to cable laying and joining of connectors.

5.2. Cable laying

- Keep to the bending radius (> 150 mm see manufacturer data sheet)
=> do not pull cables around sharp corners
- Keep to the allowable pulling force (< 500 N see manufacturer data sheet)
=> do not try to pull too long stretches in one operation
- Allow adequate cable to lie at the ends for making connections
- Mark the cable clearly at both ends (start and end identification)

If these basic matters are not observed, the result can well be a break in a cable core or shielding. These faults can sometimes occur immediately or not until weeks or months later.

- The bus cables should be laid so that they do not lie in the immediate neighbourhood of power cables (specifically frequency converters). If the fieldbus cable is led into the hazardous area, laying must be done according to the currently valid erection requirements (EN 60 079-14).

Remark: If cable laying is awarded to a subcontractor, the following points should be included in the contract:

1. Cable identification by the subcontractor (how and where)
2. Excess cable at the ends
3. Measurement of the loop impedance A and B, A and shielding
4. Isolation between A and B, A and shielding and B and shielding
5. Logging of the measurement results
6. Only cables meeting the regulations should be accepted.

5.3. Connection of the Sub-D connectors and Profibus cables

- Neatly strip the end insulation from the Profibus cable for a safe connection of the shield and sufficient strain relief of the fieldbus cable
- Insert the Profibus cable into the Sub-D connector at the correct point (the incoming cable must be connected to the entry port of the connector and the outgoing cable must be connected to the exit port).
- Terminating resistors (if present in the connector) must be switched off.
- The attachment of the bus cable identification must be of a permanent nature.

Project planning, installation and commissioning of the RS 485 field bus system of R. STAHL for the safe and hazardous area

1. Fig 9 Zone 2 and safe area Sub-D connector. The incoming and outgoing cable entries are the reverse on the Zone 1 connector. The green wire to "A1" and the red wire to "B1" for the incoming cable and to "A2" and "B2" for the outgoing cable.

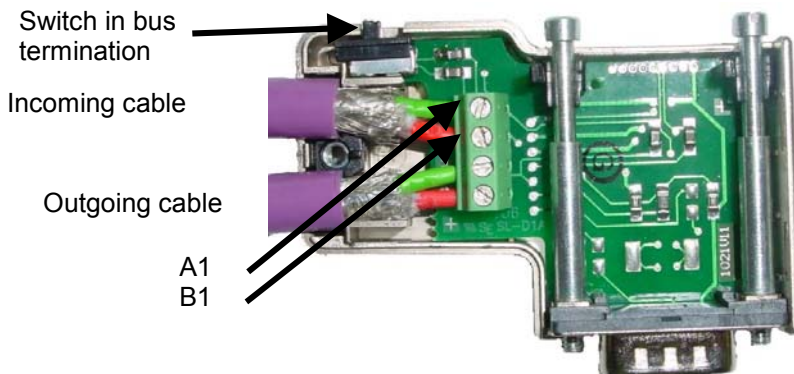

Fig 9

2. Fig 10 Zone 1 Sub-D connector. The connectors should be connected as shown in the illustration. The green wire to "A1" and the red wire to "B1" for the incoming cable and to "A2" and "B2" for the outgoing cable.

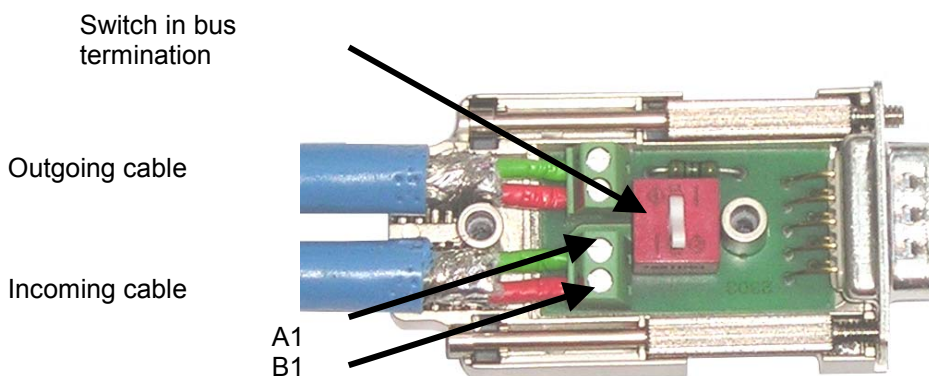

Fig 10

Project planning, installation and commissioning of the RS 485 field bus system of R. STAHL for the safe and hazardous area

5.4. Installation location and connection of the fieldbus isolating repeaters

- The fieldbus isolating repeaters can be installed in the switch compartment or in a field enclosure near to the hazardous area or in Zone 2. One exception to this rule relates to the fieldbus isolating repeaters for fibre-optic strands, types 9186/12-11-11. These are normally installed in an I.S. 1 field station in zone 1.

5.5. Measurement of the Profibus cable

After installation, it is necessary to test its quality.
There are three ways of doing this:

1. Measuring with a multimeter and checking the resistance values. This process uncovers short circuits and open circuits and gives information about the cable length.
2. Using a Profibus testing instrument, e.g. Nettest.
This device provides information about short circuits, open circuits, cable impedance, points of interference, reverse cable core connections A and B, cable length and transmission level of fieldbus devices.
3. Measurement by TDR (Time Domain Reflection). A signal generator (Profibus or Modbus Master) for edge generation is used for measurement. The measurement is evaluated with an oscilloscope. This method allows best diagnosis but is complicated and requires great experience interpreting the measured results.

Nettest can only be used for Profibus. If Modbus is to be transmitted via the RS 485 bus, measurements can be made using the multimeter. Nettest is however, an outstanding test instrument for a Profibus network; it documents all the measurements and can transfer them to a PC. This is particularly useful when verifying the installation.

Nettest can only be used to measure the cable length, impedance and junctions in an RS 485 Ex i or RS 485-IS segment. Further measurements that can be made using Nettest are designed for a standard RS 485 interface and can thus not be used.



Project planning, installation and commissioning of the RS 485 field bus system of R. STAHL for the safe and hazardous area

6. Commissioning

The most important step in commissioning a RS 485 network is the examination of the physical installation and measurement of the bus. If this has not been performed, it makes poor sense to continue with commissioning.

6.1. Bus segment in the safe area

For proper functioning of the bus segment, the bus must be terminated at both ends with active terminating resistors. These resistors can be integrated in the Sub-D connectors or in the devices themselves.

Modern Sub-D connectors with switchable terminating resistors isolate the bus cable leaving that point from the bus when the terminating resistors are switched in.

- An unreliable multiple termination of the bus is not possible.
- Simpler troubleshooting by isolation or disconnection of part segments.

6.2. Bus segment in the hazardous area

See also Chapters 4.13 and 4.14 for ordering information

RS 485-IS in accordance with PNO Specification

For proper functioning of the bus segment, the bus must be terminated at the front end with an active terminating resistor.

- On the 9185, the internal terminating resistor in the Sub-D connector type 94 900 02 22 0 is switched ON and the DIP switches on the front SCAN and RS2 set to OFF and PNO set to ON.

The terminating resistor in the type 94 900 02 22 0 connector is switched on at the end of the bus segment.

RS 485 Ex i in accordance with R. STAHL specification

If a type 9373/21.. fieldbus isolating repeater is used, the bus must be terminated on the fieldbus isolating repeater with 470 ohms parallel to the active terminating resistor in the fieldbus isolating repeater.

If a type 9185 fieldbus isolating repeater is used, the Sub-D connector type 94 900 03 22 0 must be used on the fieldbus isolating repeater .

The DIP switches on the front SCAN and RS 2 set to OFF and PNO set to ON (see also 9185 operating instructions).

The end of the bus segment must be terminated by a type 94 900 03 22 0 Sub-D connector from R. STAHL.



Project planning, installation and commissioning of the RS 485 field bus system of R. STAHL for the safe and hazardous area

6.3. Checking and setting the fieldbus devices

- Address
- Configuration (GSD, programming, etc.)
- Power supply
- Repeater, field bus isolating repeater (speed setting)

6.4. Commissioning the master

- Configuration of the bus master
- Master tools (ComProfibus)
- Connection of the bus segment to the bus master

Check whether the bus master can access all fieldbus devices
⇒ What quality is achieved, error, magnitude etc.?

A good bus should not indicate errors in the normal operating state. If errors occur, these must be eliminated since minor / rare errors become serious problems over the course of time.

Project planning, installation and commissioning of the RS 485 field bus system of R. STAHL for the safe and hazardous area

7. Troubleshooting

Troubleshooting can be split into two groups:

- a. The logical search using a bus analyser that carries out an analysis of the protocol and data link levels. This records and plays back telegram traffic. It is important to note that the bus analysers partly indicate faults e.g. defective telegrams and the Profibus master runs without faults (special Profibus analyser with Siemens ASPC 2 chip in monitor mode are affected here). This means that a bus which is really stable will be tested as bad by the Profibus analyser. A serial analyser is suitable for the Modbus or the Servciebus.
- b. On the physical level using an oscilloscope. This determines how good the construction of the bus segment is. This is necessary should the logical examination show that many telegrams have been destroyed. The oscilloscope can show bus faults such as open circuits, short circuits, mismatch, junctions, quiescent level and transmission levels of individual fieldbus devices.

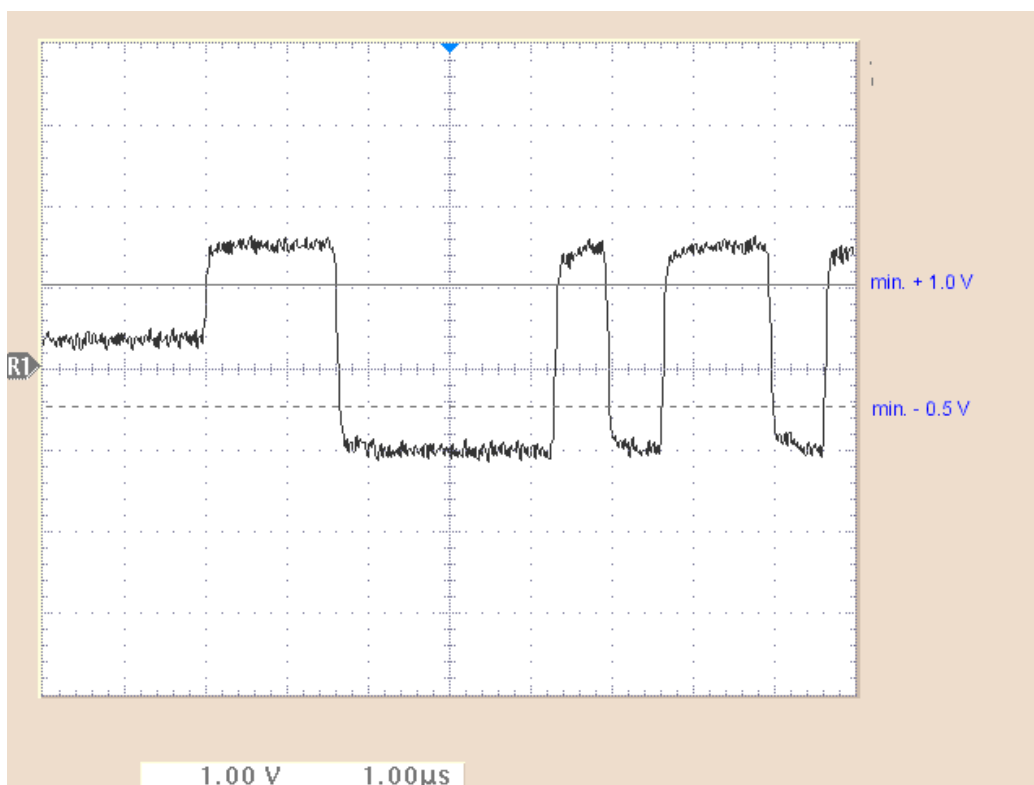

Fig 11 Minimum transmission levels on the RS 485 Ex i bus in accordance with R. STAHL Specification. The level should be above + 1 V and below – 0.5 V. The quiescent level is approx. 0.2 to 0.3 V in the case of a correctly terminated bus.

The permissible signal form and notes concerning trouble shooting for the RS 485-IS are detailed in the “Profibus RS 485-IS User and Installation Guideline; Number 2262 Rev”. 1.1, dated June 2003.

Project planning, installation and commissioning of the RS 485 field bus system of R. STAHL for the safe and hazardous area

7.1. Troubleshooting with simple measuring instruments, procedure

1. Procurement of the bus topology documentation
 - with positioning of the individual fieldbus devices
 - and line lengths
2. Determining the fault behaviour
 - occurrence of the faults
 - sporadic => loose contact (loose wires or shielding)
 - reproducible => ambient influences (temperature; humidity), project planning errors (cables, lengths, control and instrumentation system)

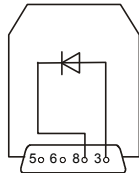
The fault behaviour allows conclusions to be drawn as to the method of troubleshooting.
3. Setting/checking the users (bus address, terminating resistors and earthing (shielding))
4. Check whether the correct cable has been used (measurement of the loop resistance, printed information on cable)
5. Check whether all connectors have been connected neatly and correctly (stripping the insulation from the cable)
6. Are the wires connected (screws tightened, or wire simply slid beneath, open circuit, short circuits)?
7. Switching of the terminating resistors => how does the bus behave (RxD and TxD LED indicators on the fieldbus isolating repeater)?
8. In some cases, deactivation of field stations via the Profibus connectors in order to localise faults
9. Test of Sub-D socket for detecting reversed wires.
10. The test socket must be connected to the bus cable on the master (front end of the bus). Then measure the resistance value (∞ or 1...10 kOhm) with a multimeter depending on polarity, starting at the first Sub-D connector after the front end of the bus.
 
11. All bus terminating resistors must be switched off before measurement.

If a wire has been mistakenly reversed from one connector to the next, a resistance value between 1...10 kOhm will be measured, depending on the multimeter, if measurement is conducted with the correct polarity. Pin 3 is B +. This is the positive wire. Pin 8 is A -. This is the negative wire.

=> Check connectors.

After working through Points 1 to 8, the fieldbus should operate correctly in 90 % of all cases. If not, it is advisable to use corresponding measuring instruments. This requires a thorough knowledge of the fieldbus and its behaviour in the event of faults and errors.