

6125/2122-3501-6015-331 Art. No. 284564



- LED high-power floodlight with power consumption of up to 225 W
- Wide-range voltage input between 110 V and 277 V (50 Hz and 60 Hz)
- Suitable for operation in central battery systems and DC mains (176 V to 264 V DC)
- Three wattage classes are available: 100 W, 160 W and 225 W
- An enclosure made from stainless steel 316L is also available for marine and offshore applications.
- Optionally available with DALI interface

MY R. STAHL 6125B



The new generation of LED floodlights for Zone 1 also relies on the tried-and-tested, robust stainless steel enclosure (optionally seawater-resistant stainless steel 316L). However, thanks to their smaller design and a new generation of drivers, they weigh significantly less, thereby improving ergonomics during installation and operation. Now with three power classes and the three tried-and-tested light distribution curves, the LED floodlight generates three colours of LED light – warm white, neutral white and cold white.

Technical Data

Explosion Protection

Application range (zones)	1 2 21 22
IECEX gas certificate	IECEX EPS 15.0087
IECEX gas explosion protection	Ex db eb op is IIC T4 Gb
IECEX dust certificate	IECEX EPS 15.0087
IECEX dust explosion protection	Ex tb op is IIIC T100 °C Db
ATEX gas certificate	EPS 15 ATEX 1 114
ATEX gas explosion protection	Ex II 2 G Ex db eb op is IIC T4 Gb
ATEX dust certificate	EPS 15 ATEX 1 114
ATEX dust explosion protection	Ex II 2 D Ex tb op is IIIC T100 °C Db
Certificates	ATEX (BVIS), Brazil (ULB), IECEX (BVIS), India (PESO)
Ship approval	DNVGL
Declaration of Conformity	ATEX (EUK)

Electrical Data

Rated operational voltage AC	110 – 277 V
Frequency range	50 – 60 Hz

Lighting Data

Lamp wattage	160 W
Lamp type	LED
Lamp	LED
Light colour	Neutral white
Light distribution	Medium-beam
Luminaire efficacy	99 lm/W
Luminous flux	15413 lm

6125/2122-3501-6015-331 Art. No. 284564

Lighting Data

Colour rendering	≥ 80
Colour temperature	5000 K

Ambient Conditions

Ambient temperature	-60 °C ... +60 °C
Storage temperature	-40 °C ... +75 °C

Mechanical Data

Degree of protection (IP)	IP66
Class	I
Enclosure material	Stainless steel 1.4301, Powder-coated Single-layer powder-coated
Enclosure colour	Similar to RAL 9010
Sealing material	Silicone
Pane material	Reinforced glass
Max. solid connection terminals	6 mm ²
Max. finely stranded connection terminals	4 mm ²
Type of connection cable	Finely stranded Solid
Width	400 mm
Height	84 mm
Length	520 mm
Impact strength (IEC 62262)	IK10
Fastening	With bracket, SS304
Weight	18.5 kg
Weight	40.79 lb

Mounting / Installation

Note about mounting	Provided
---------------------	----------

Components

Drilled holes	3 x M25
Cable glands and entries	1 x M25 x 1.5 CMP-25A2F
Material cable gland	Nickel-plated brass
Stopping plugs	2 x M25 x 1.5
Stopping plug material	Polyamide, black

6125/2122-3501-6015-331 Art. No. 284564

Light Distribution Curves

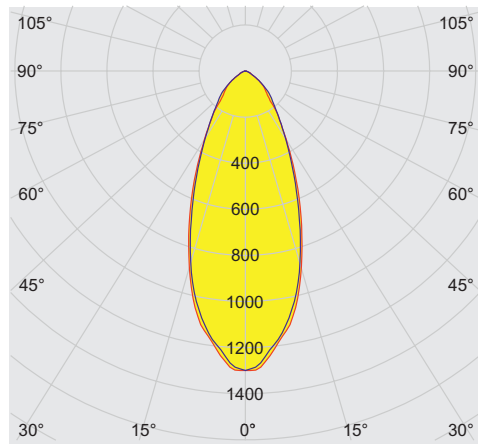

cd/klm 100%

— C0 - C180 — C90 - C270

typ. medium beam

Dimensional Drawings (All Dimensions in mm [inches]) – Subject to Alterations

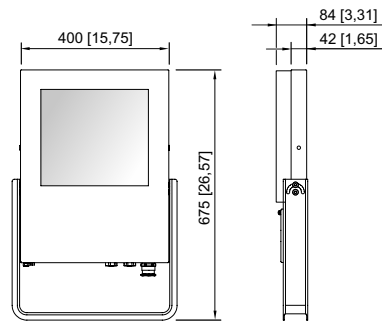
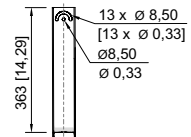
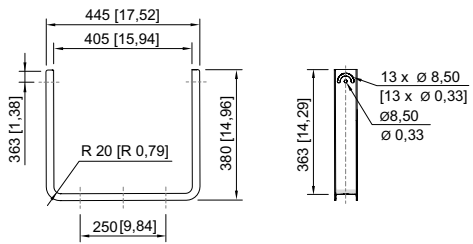

Floodlight with cooling element

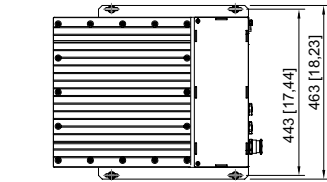
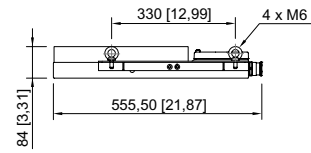

Floodlight with cooling element, with ring eyes

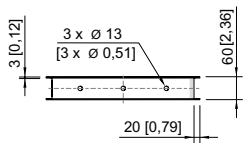

Mounting bracket

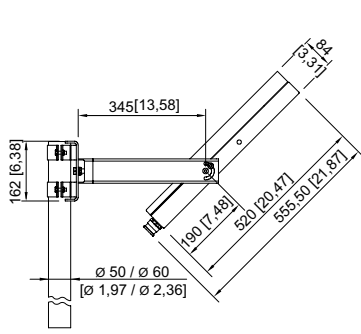

Floodlight with pole mounting

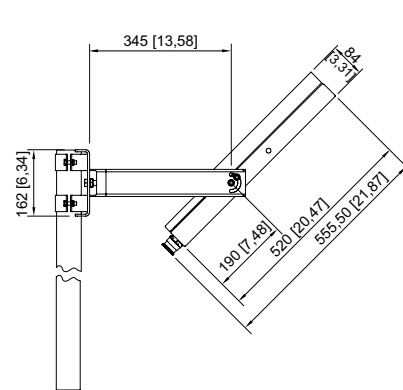
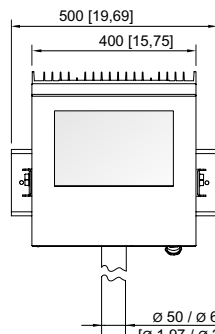
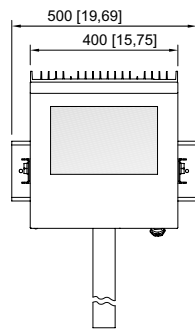

6125/2122-3501-6015-331 Art. No. 284564



6125/2122-3501-6015-331 Art. No. 284564

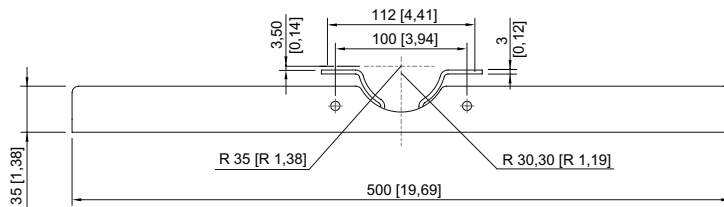
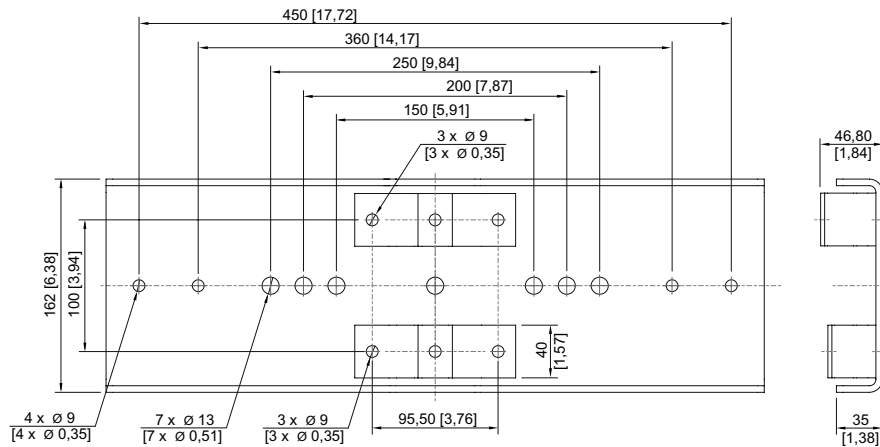
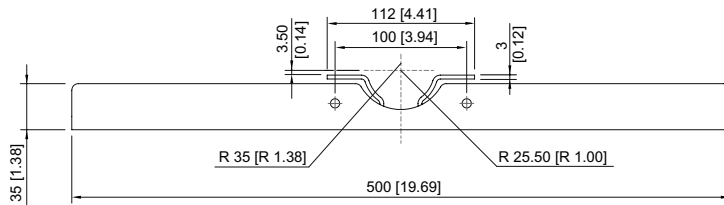

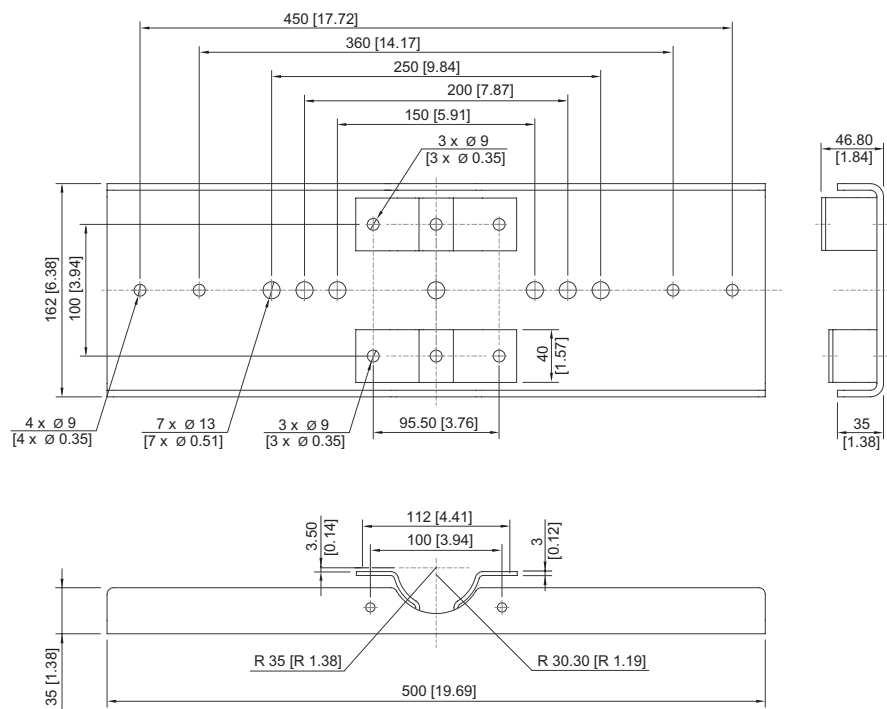

Accessories

Mounting set

		Art. No.
	for pendant mounting with ring bolts included - stainless steel SS316L (1.4404 or V4A) without powder coating	257464
	for pole mounting with pole diameter of 50 mm - stainless steel SS316L (1.4404 or V4A) without powder coating	283361
	for pole mounting with pole diameter of 60 mm - stainless steel SS316L (1.4404 or V4A) without powder coating	263824

Ring bolt

		Art. No.
	M6 (4 pieces), direct mounting in insert nuts	254234

Mounting bracket

		Art. No.
	Sheet steel, single powder coated	244604
	Stainless steel SS316L (1.4404 or V4A) without powder coating	221589

We reserve the right to make alterations to the technical data, dimensions, weights, designs and products available without notice. The illustrations cannot be considered binding.