

Control and signalling devices

LED indicator lamp for panel mounting

8013/322-al UL Art. No. 129111



- Beneficial LED technology: Extremely long service life, high luminance, low heat build-up
- For installation in enclosure walls, enclosure covers, panels, control cabinets
- Versions with spring clamp terminal with or without connection chamber or versions with prefabricated connection cable and connection chamber are available

MY R. STAHL 8013A



R. STAHL Series 8013 LED indicator lamps show command statuses via a light signal, the colour of which can be determined using the colour filter included in the delivery: Red, yellow, green, blue or white. The long-lasting LED ensures high luminance and low heat build-up. Versions with spring clamp terminal with or without connection chamber and versions with prefabricated connection cable and connection chamber are available.

Technical Data

Explosion Protection

Scope of validity	European Union (ATEX) CEC IECEX NEC
Application range (zones)	1 2 21 22
IECEX gas certificate	IECEX PTB 07.0012 U
IECEX gas explosion protection	Ex db mb ia IIC Gb
ATEX gas certificate	PTB 02 ATEX 2130 U
ATEX gas explosion protection	Ⓔ II 2 G Ex db mb ia IIC Gb
UL gas certificate	E81680V1S9
Certificates	ATEX (PTB), Canada (UL), China (CQST), IECEX (PTB), USA (UL)
Declaration of Conformity	Certificate of conformity (ATEX), China (CCC)
Notes	Product label may vary. Series devices are labelled with ATEX, IECEX, NEC and CE Code.

Safety Data

Max. capacitance C_i	Negligible
Max. inductance L_i	Negligible
Max. voltage U_i	28 V
Max. current I_i	150 mA
Max. power P_i	1 W

Electrical Data

Rated operational voltage AC	10.8 – 28 V
Rated operational voltage DC	10.8 ... 28 V
AC UL rated operational voltage	28 V

Control and signalling devices

LED indicator lamp for panel mounting



8013/322-al UL Art. No. 129111

Electrical Data

Rated operational current	12 mA
Frequency	0 to 60 Hz
UL rated operational current	0.15 A
Rated operational power	0.6 W
Electrical service life	10 ⁵ lighting hours

Lighting Data

Lamp	White LED
Luminous colour	Blue Green Red White Yellow

Ambient Conditions

Ambient temperature	-30 °C ... +60 °C
Ambient temperature	-22 °F ... +140 °F

Mechanical Data

Version	Without connection chamber
Degree of protection (IP) (IEC 60529)	Reverse side IP20, front side IP66
Enclosure material	Polyamide
Silicone-free	Yes
Connection cross-section	0.5 ... 2.5 mm ²
Connection cross-section AWG	18 AWG ... 12 AWG
Packaging unit	1
Weight	110 g
Weight	0.243 lb

Mounting / Installation

Tightening torque	1.2 Nm
Tightening torque lbf in	10.62 lbf in
Connection	Spring terminal connection

Dimensional Drawings (All Dimensions in mm [inches]) – Subject to Alterations

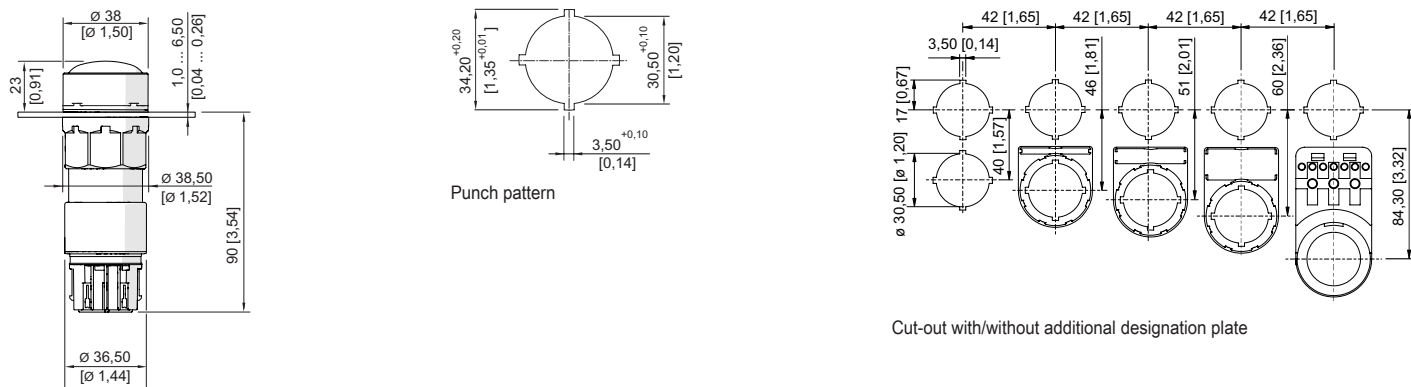

8013/3.2 indicator lamp without connection chamber

Spare Parts

Lens

Art. No.

Control and signalling devices



LED indicator lamp for panel mounting





8013/322-al UL Art. No. 129111

	red	155842
	yellow	155834
	green	155852
	blue	155860
	white	155824

Closing part		Art. No.
	8602C3-733-B for closing unused holes in cover, dia. 30.5 mm, NBR	244306
	8602C3-733-S for closing unused holes in cover, dia. 30.5 mm, silicone	244307

Insert discs for label holder		Art. No.
	One-line Plain Material: PVC Colour: White Self-adhesive	238271
	Two-line Plain Material: PVC Colour: White Self-adhesive	238272
	Three-line Plain Material: PVC Colour: White Self-adhesive	238273

Label holder		Art. No.
	Label holder, size 1, without insert disc Labelling: 1-line can be installed in dia. 30.5 mm drilled holes for actuators	155632
	Label holder, size 2, without insert disc Labelling: 1- or 2-line can be installed in dia. 30.5 mm drilled holes for actuators	155687
	Label holder, size 3, without insert disc Labelling: 1-, 2- or 3-line can be installed in dia. 30.5 mm drilled holes for actuators	155844

We reserve the right to make alterations to the technical data, dimensions, weights, designs and products available without notice. The illustrations cannot be considered binding.