

Remote I/O

IS1+ Remote I/O HART analog universal module

For Zone 1 Ex i

9468/32-08-11 Art. No. 210659



- 8 channels can be used individually as inputs or outputs
- Intrinsically safe Ex ia IIC inputs/outputs with line fault monitoring and an LED fault and status display for each channel
- Module in Zone 1 can be replaced without having to disconnect the power supply (i.e. hot-swapped)

MY R. STAHL 9468A



The 9468/32 HART analogue universal module for Zone 1 has eight channels which can be used separately for Ex i operation of 2-/3-conductor HART transmitters, 4-conductor transmitters or control valves/positioners with 0/4 to 20 mA signals. HART communication is bidirectional. All inputs/outputs are short-circuit proof, galvanically separated from the system and individually monitored to check for line faults.

Technical Data

Explosion Protection

Application range (zones)	1 2
Application range (Zone) note	An enclosure that is suitable for the application must be used. See operating instructions.
Ex interface zone	0 1 2 20 21 22
IECEX gas certificate	IECEX DEK 12.0054X
IECEX gas explosion protection	Ex ia [ia Ga] IIC T4 Gb
IECEX dust certificate	IECEX DEK 12.0054X
IECEX dust explosion protection	[Ex ia Da] IIIC
ATEX gas certificate	DEKRA 12 ATEX0173 X
ATEX gas explosion protection	Ex II 2 (1) G Ex ia [ia Ga] IIC T4 Gb
ATEX dust certificate	DEKRA 12 ATEX0173 X
ATEX dust explosion protection	Ex II (1) D [Ex ia Da] IIIC
FMus certificate	FM17US0332X
cFM certificate	FM16CA0134X
Marking cFMus	IS, Class I, Div. 1, Groups A,B,C,D; Class I, Zone 1, AEx/Ex ia [ia] IIC AIS Class I,II,III, Div. 1, Groups A,B,C,D,E,F,G; T4 at Ta = 75°C See Doc. 9468 6 031 001 1
Certificates	ATEX (DEK), Brazil (ULB), Canada (FM), China (NEPSI), IECEX (DEK), India (PESO), Korea (KTL), USA (FM)
Ship approval	ABS, BVIS, EU RO MR (DNV), KR, LR

Remote I/O

IS1+ Remote I/O HART analog universal module

For Zone 1 Ex i

9468/32-08-11 Art. No. 210659



Explosion Protection

Declaration of Conformity	ATEX (EUK), China (CCC)
Installation	Zone 1, Zone 2 and safe areas
Further information	See operating instructions and certificate

Safety Data

Max. voltage U_o	24.4 V
Max. current I_o (2-conductor)	80 mA
Max. power P_o (2-conductor)	488 mW
Max. current I_o (3-conductor)	81.8 mA
Max. power P_o (3-conductor)	499 mW
Internal capacitance	Negligible
Internal inductance	Negligible

Max. connectable inductance L_o /capacitance C_o									
2-conductor input/output									
IIC	L_o [mH]	3.8	2	1	0.5	0.2			
	C_o [nF]	53	59	71	88	119			
IIB	L_o [mH]	23	10	2	1	0.5	0.2	0.1	0.05
	C_o [nF]	370	430	430	470	550	700	860	890
3-conductor input									
IIC	L_o [mH]	3.6	2	1	0.5	0.2			
	C_o [nF]	53	58	70	87	119			
IIB	L_o [mH]	21	10	2	1	0.5	0.2	0.1	0.05
	C_o [nF]	380	420	420	470	550	700	860	890

Limiting values

4-conductor transmitters	U_o , I_o , P_o , C_i und L_i are negligible. Maximum connectable safety characteristic values during operation with active 4-conductor transmitters:		
	Max. input voltage U_i [V]	Max. input current I_i [mA]	Max. ambient temperature T_{amb} [°C]
	28	150	55
	28	140	60
	28	130	65
	28	115	70
	28	105	75

Electrical Data

Number of channels	8 Ex i inputs/outputs
Channels	Each can be configured as input or output (3-conductor, 4-conductor transmitters or active mA sources occupy 2 channels)
Nominal signal	4 to 20 mA 0 to 20 mA
Min. signal	0 mA

Remote I/O

IS1+ Remote I/O HART analog universal module

For Zone 1 Ex i

9468/32-08-11 Art. No. 210659



Electrical Data

Supply voltage	16 V, at 20 mA for 2-conductor transmitters
Communication signal	HART protocol
Connection Ex i field signals	Pluggable, blue terminals, 16-pin, 2.5 mm ² , screw type or cage clamp version with lock
Notes	In order to operate an active 4-conductor HART transmitter, a 9164 must be connected between each channel. A 9164 is not required when operating a 4-conductor transmitter without HART communication.

Signal transmission	Filter time constant (adjustable parameters)		
	Small	Medium	50 Hz, 60 Hz
Measurement discrimination in the range 4 to 20 mA	14.75 bit (with HART: 12.75 bit)	14.75 bit	14.75 bit
Maximum delay from signal/internal bus	32 ms	120 ms	500 ms

Auxiliary Power

Power supply connection	BusRail types 9494
Auxiliary power version	Intrinsically safe Ex ia via BusRail
Current consumption	220 mA (at 20 mA per channel)
Max. power consumption	5.3 W (at 20 mA/channel)
Max. power dissipation outputs	3.7 W (at 20 mA, 500 Ω/channel)
Max. power dissipation inputs	2.7 W (at 20 mA/channel)

Galvanic Isolation

Test voltage for galvanic separation	Acc. to standard EN 60079-11
Auxiliary power/system components	≥ 1500 V AC
I/O module / I/O module	≥ 500 V AC
I/O channels/system components	≥ 500 V AC
I/O channels / ground (PA)	≥ 500 V AC

Input

Max. signal for input	23.5 mA
Max. input short-circuit current	24 mA
Max. input resistance	14.1 Ω per channel

Output

Output step response (10 to 90%)	40 ms
Max. output short-circuit current	23,5 mA (0 ... 20 mA) 22,8 mA (4 ... 20 mA)
Max. signal for output	23.5 mA (0 to 20 mA) 22.8 mA (4 to 20 mA)
Output max. load resistance	750 ohm at 20 mA 700 Ω at 21.8 mA
Open-circuit voltage U _a	22.5 V

Device Specific Data

Signal type	Output Input
Diagnostics message module	ON OFF

Remote I/O

IS1+ Remote I/O HART analog universal module

For Zone 1 Ex i

9468/32-08-11 Art. No. 210659



Device Specific Data

Signal filter module	50 Hz large 60 Hz large medium small
Scan HART live list module	ON OFF
Signal range	4 ... 20 mA 0 ... 20 mA
Input measuring range	2.4 to 22.8 or 23.5 mA 3.6 to 21 mA (acc. to NAMUR)
Line fault monitoring	ON OFF
Input behaviour in case of error	Alarm code, keep last value 110% 100% 0% -10%
Output behaviour in case of error	110% 100% 0% -10% Keep last value
Cyclical data transmission of HART variants	4HV 8HV No
LED module requires maintenance	"M/S" LED, blue
LED operating conditions	"RUN" LED, green
LED channel error	LED for each channel, red
Channel status LEDs	Yes
Retrievable parameters	Type Software revision Serial number Manufacturer Hardware revision
Module status and alarms	Primary/redundant internal bus error No response from IOM Configuration different from module Hardware error Overtemperature Slot error Module requires maintenance
Signal status bit	1 = Signal valid 0 = Signal interrupted
Wire breakage input	(adjustable parameters, at 4 to 20 mA) < 2,4 mA / 3,6 mA
Short circuit input	> 23.5 mA > 22.8 mA/> 21 mA (adjustable parameters)
Wire breakage output	Terminal voltage > 16 V (response range 16 V to 16.5 V) or output current can no longer be adjusted
Short circuit output	Output load < 60 Ω (response range 40 to 60 Ω)

Remote I/O

IS1+ Remote I/O HART analog universal module

For Zone 1 Ex i

9468/32-08-11 Art. No. 210659



Device Specific Data

Influence of ambient temperature	< 0,03 % / 10 K		
Accuracy of measurement			
Error of measurement with filter time constant	Small	Medium	50 Hz, 60 Hz
Maximum error of measurement	0.075% (12 µA at 4 to 20 mA)	0.005% (8 µA at 4 to 20 mA)	0.005% (8 µA at 4 to 20 mA)

Note: All information in % of the signal span at 23 °C

Diagnostics

LED group error	"ERR" LED, red
-----------------	----------------

Ambient Conditions

Ambient temperature	-40 °C ... +75 °C Observe operating instructions
Ambient temperature	-40°F ... +167°F Observe operating instructions
Storage temperature	-40 °C ... +80 °C
Storage temperature	-40°F ... +176°F
Max. operating altitude	< 2000 m
Max. relative humidity	95% (without condensation)
Shock (semi-sinusoidal)	(IEC EN 60068-2-27) 15 g (3 shocks per axis and direction)
Vibration (sinusoidal)	(IEC EN 60068-2-6) Frequency range 2 to 13.2 Hz Amplitude 1 mm (peak value) Frequency range 13.2 to 100 Hz Acceleration amplitude 0.7 g
Electromagnetic compatibility	Tested to the following standards and regulations: EN 61326-1 (2006) IEC 61000-4-1 to 61000-4-6, NAMUR NE 21

Mechanical Data

Degree of protection (IP) (IEC 60529)	IP20
Module enclosure	Polyamide 6GF
Fire resistance (UL 94)	V2
Pollutant class	Corresponds to G3
Width	96.5 mm
Width, inches	3.8 in
Depth	68 mm
Length	128 mm
Length, inches	5.04 in
Mounting depth, inches	2.64 in
Weight	275 g
Weight	0.61 lb

Mounting / Installation

Mounting orientation	Vertical Horizontal
----------------------	------------------------

Remote I/O

IS1+ Remote I/O HART analog universal module

For Zone 1 Ex i





9468/32-08-11 Art. No. 210659

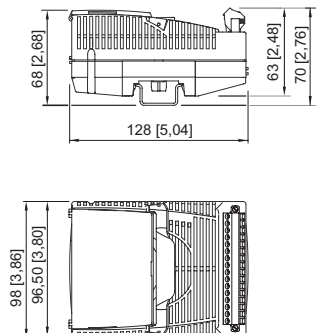

Dimensional Drawings (All Dimensions in mm [inches]) – Subject to Alterations



Accessories

Pluggable terminal		Art. No.
	2.5 mm ² with lock, 16-pin, screw connector, blue, for connecting the field signals to I/O modules, for intrinsically safe field circuits Labelling: 1 to 16 Note: A second terminal is additionally required for I/O module Series 9470 and 9482 Labelling: 17 to 32	162702
	2.5 mm ² with lock, 16-pin, spring clamp connection, blue, for connecting the field signals to I/O modules, for intrinsically safe field circuits, incl. test jacks Labelling: 1 to 16 Note: A second terminal is additionally required for I/O module Series 9470 and 9482 Labelling: 17 to 32	162695
Electronic relay		Art. No.
	The electronic relay modules are used to switch Ex e loads using an intrinsically safe (Ex i) or non-intrinsically safe (Ex e) control system. Coil circuit: Ex i or non-Ex i (Ex e)* Contact circuit: Non-Ex i (Ex e) *It is possible to switch between Ex i and non-Ex i circuits, or vice versa, at any time without restriction. Note: Cannot be used with 9475/32-04-12, 9475/32-08-52, 9475/33-08-50	282457
	The 9174 electronic relay module makes it possible to switch Ex e loads using an intrinsically safe control system. Input: Ex i; output: 31.2 V/2 A DC, Ex e	212340
Ex i/Ex e relay module for Zone 1		Art. No.
	The Ex i/Ex e relay module is used for the galvanically isolated switching of intrinsically safe (Ex i) and non-Ex i (Ex e) electrical circuits. Coil circuit: Ex i or non-Ex i (Ex e) Contact circuit: Ex i or non-Ex i (Ex e) Thanks to the integrated safeguarding for the contact and coil circuit, additional safeguarding is not necessary. Note: no usable with 9475/32-04-12, 9475/32-08-52, 9475/33-08-50	273000

Remote I/O

IS1+ Remote I/O HART analog universal module

For Zone 1 Ex i

9468/32-08-11 Art. No. 210659



mA isolating repeater

Art. No.



The mA isolating repeaters are used to connect 4-wire transmitters to active 2-wire inputs and for galvanic separation.
Input: Sink, Ex e
Output: Sink, Ex i

224365



The mA isolating repeaters are used to connect 4-wire transmitters to active 2-wire inputs and for galvanic separation.
Input: Sink, Ex i
Output: Sink, Ex i

224364

Resistor error message suppression

Art. No.

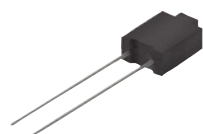

The resistors are used to suppress error messages for unused I/O channels
Resistance value: 5K6/0.5 W
Suitable for: AIM 9468; UMH 9469; DIOM 9470; DIOM 9471; DIOM 9472; DOM 9475
For intrinsically safe circuits (simple apparatus according to EN 60079-11)

244911

The resistors are used to suppress error messages for unused I/O channels
Resistance value: 62R/0.5 W
Suitable for: AOM 9468; UMH 9469; DIOM 9472; TIM 9482

244912

Partition

Art. No.



For mounting between intrinsically safe and non-intrinsically safe connections between I/O modules to maintain a tight string length of 50 mm

220101

Warning label

Art. No.



"Clean modules only with a damp cloth."

162796

DIN A4 sheet

Art. No.



For label plate on I/O modules; 6 plates per sheet;
IS Wizard printout; packaging unit = 20 sheets

162832

Labelling strips

Art. No.

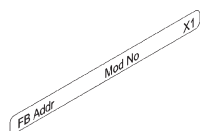

"FB Addr ... Mod No ..." for pluggable terminal, 26 pieces on the sheet

162788

Vibration bracket set

Art. No.



When installed in environments with extreme vibration (> 0.7 g and max. 4 g), the 9490 vibration brackets may be used as an additional measure and provide mechanical stability for the individual modules.

For mounting: All I/O modules, except 9477/12 and 9478

Number of brackets in a set: 8

Screws (item no. 275516) must be ordered separately.

271920

Remote I/O

IS1+ Remote I/O HART analog universal module

For Zone 1 Ex i

9468/32-08-11 Art. No. 210659



Set of screws	Art. No.
Set of M5 x 14 screws (self-tapping) for 9490 vibration brackets Number of screws in a set: 25	275516

We reserve the right to make alterations to the technical data, dimensions, weights, designs and products available without notice. The illustrations cannot be considered binding.