

Signalling devices



Aud./vis. signalling device Horn/XENON light fitting

In flameproof enclosure

YL60/324-DL 101-00AW30-ST000-0000 Art. No. 319424



- The latest generation of audible and visual alarm devices
- Ex d/Ex e connection chambers
- Visual solutions with 5 to 21 J XENON and high-power LEDs with various light modes and 4 light channels
- Audible solutions with directional or omnidirectional horn with up to 120 dB(A) at 1 m, 4 tone channels and 64 preconfigured tones
- Four output levels can be configured
- Brackets, fixings and protective grid made from stainless steel
- Compliant with EN 54/DNV
- Fastening bracket and protective cage included

MY R. STAHL YL60C



The **YL60/3 product series** provides audible and visual alarm signals which can be used to alert, warn or draw attention to equipment malfunction/start-up or any number of safety-related issues in hazardous areas. The preconfigured signal tones and light patterns (LED) provide a wide range of internationally standardised signal patterns. The audible and visual signals can be operated separately or in combination, with four channels available for each type of signal, enabling flexible use. The signalling devices meet the requirements of EN 54 and DNV for extremely challenging ambient conditions.

Technical Data

Explosion Protection

Scope of validity	European Union (ATEX) IECEX United Kingdom
Application range (zones)	1 2 21 22
IECEX gas certificate	IECEX EPS 22.0046X
IECEX gas explosion protection	Ex db eb IIC T4 Gb
IECEX dust certificate	IECEX EPS 22.0046X
IECEX dust explosion protection	Ex tb IIIC T100 °C Db
ATEX gas certificate	EPS 22 ATEX 1 224X
ATEX gas explosion protection	⊕ II 2 G Ex db eb IIC T4 Gb
ATEX dust certificate	EPS 22 ATEX 1 224X
ATEX dust explosion protection	⊕ II 2 D Ex tb IIIC T100 °C Db
Certificates	ATEX (BVIS), IECEX (BVIS)
Declaration of Conformity	ATEX (EUK)

Electrical Data

Rated operational voltage DC	12 ... 27.2 V
Line monitoring	Yes
Tolerance	-10 ... 10 %

Acoustic Data

Horn version	directional
Sound pressure level	max. 120 dB(A) @ 1 m
Sound level	4

Signalling devices



Aud./vis. signalling device Horn/XENON light fitting

In flameproof enclosure

YL60/324-DL101-00AW30-ST000-0000 Art. No. 319424

Acoustic Data

Volume control	Max. -18 dB(A) adjustment
----------------	---------------------------

Lighting Data

Lamp	5 J xenon flash tubes
------	-----------------------

Effective luminous intensity (1 Hz, flashing)	87 cd
---	-------

Ambient Conditions

Ambient temperature	-40 °C ... 70 °C (T4)
---------------------	-----------------------

Storage temperature	-60 °C ... 70 °C
---------------------	------------------

Mechanical Data

IP degree of protection (IEC 60598)	IP66
-------------------------------------	------

Connection chamber version	Ex e
----------------------------	------

Enclosure material	Aluminium, powder-coated, Seawater-resistant
--------------------	--

Enclosure colour	red, similar to RAL 3020
------------------	--------------------------

Silicone-free content	Contains silicone
-----------------------	-------------------

Trumpet material	PC/PBT
------------------	--------

Material dome	Polycarbonate, prismatic
---------------	--------------------------

Protective collar material	Polycarbonate (PC cover)
----------------------------	--------------------------

Wire guard material	Stainless steel
---------------------	-----------------

Max. solid connection terminals	4 mm ²
---------------------------------	-------------------

Max. finely stranded connection terminals	2.5 mm ²
---	---------------------

Width	211.8 mm
-------	----------

Height	435 mm
--------	--------

Length	211.8 mm
--------	----------

Lens colour	Amber
-------------	-------

Fastening	Ceiling mount bracket
-----------	-----------------------

Weight	8.39 kg
--------	---------

Weight	18.49 lb
--------	----------

Mounting / Installation

Connection type	Push in
-----------------	---------

Mounting part material	Stainless steel
------------------------	-----------------

Components

Drilled holes	2 x M20 + 2 x M25
---------------	-------------------

Cable glands and entries	1 x M20 Ø 4 ... 13 mm 1 x M25 Ø 7 ...
--------------------------	--

Material cable gland	Polyamide, black
----------------------	------------------

Stopping plugs	2x M20 + 2x M25
----------------	-----------------

Stopping plug material	Polyamide, black
------------------------	------------------

Signalling devices

Aud./vis. signalling device Horn/XENON light fitting

In flameproof enclosure

YL60/324-DL101-00AW30-ST000-0000 Art. No. 319424



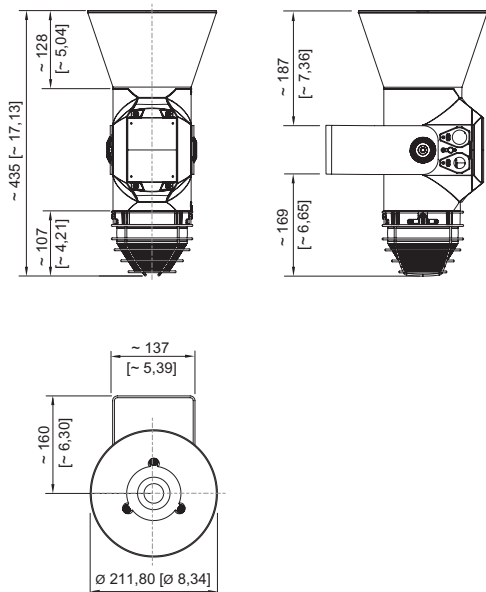

Dimensional Drawings (All Dimensions in mm [inches]) – Subject to Alterations



YL60/3 directional horn

Accessories

Metal cable gland

		Art. No.
	Ex d and Ex e cable gland with compound for all types of armoured cables (SWA, wire-braid, tape) (nickel-plated brass) Type 20PX2K, M20 x 1.5	109428
	Ex d and Ex e cable glands with RapidEx sealing system for all types of unarmoured cables and wire-braid-armoured cables (nickel-plated brass) Type 20PX2K-REX, M20 x 1.5	246649
	Ex d and Ex e cable glands with compound for all types of unarmoured cables and wire-braid-armoured cables (nickel-plated brass) Type 20PXSS2K, M20 x 1.5	109441
	Ex d and Ex e cable glands with RapidEx sealing system for all types of unarmoured cables and wire-braid-armoured cables (nickel-plated brass) Type 20PXSS2K-REX, M20 x 1.5	246605

Cable gland made of plastic

		Art. No.
	8161/7-M20-1304, Ex e Plastic, M20 x 1.5, cable outer diameter 4 to 13 mm Lot size 50 pieces	239156

Stopping plug

		Art. No.
	8290/3-M20 Plastic, M20 x 1.5 Lot size 1 piece	143522
	8290/3-M20 Plastic, M20 x 1.5 Lot size 100 pieces	285773

Signalling devices

STAHL



Aud./vis. signalling device Horn/XENON light fitting

In flameproof enclosure

YL60/324-DL101-00AW30-ST000-0000 Art. No. 319424

Mounting accessories

Art. No.

	L-bracket, stainless steel 1.4404	319271
	U-bracket, stainless steel 1.4404	319280

Protective cage

Art. No.

	Protective cage, stainless steel 1.4404	319272
--	---	--------

Spare Parts

Textured lens

Art. No.

	amber	319273
--	-------	--------

Lamp

Art. No.

	Xenon tube PCB 5 joules	319281
--	-------------------------	--------

Shaped horn

Art. No.

	directional, repair kit	319249
--	-------------------------	--------

We reserve the right to make alterations to the technical data, dimensions, weights, designs and products available without notice. The illustrations cannot be considered binding.