

Lighting

Linear luminaire With LED

GRP industrial design

L402/4348-6100-152-1110-11-8650 Art. No. 272002



- Highly resistant industrial design
- Linear luminaire with long-life, efficient LED technology (up to 138 lm/W)
- Lightweight yet extremely robust, with an impact strength rating of IK10

MY R. STAHL L402A

The EXLUX L402/4 luminaire is designed for industrial use and can be fitted to the ceiling, a pole, or alternatively, it can be suspended. A bright light for not much energy is what you get with this efficient LED technology, which offers the added benefit of increased service life – this can be as much as 100,000 hours. The plastic enclosure is easily to open by a central lock.

Technical Data

Explosion Protection	
Ex version	Industrial design
Electrical Data	
Rated operational voltage AC	100 – 240 V
Rated operational voltage DC	200 ... 250 V
Frequency range	50 – 60 Hz
Lighting Data	
Number of lamps	1
Lamp wattage	42 W
Lamp	LED
Light colour	6500 K – daylight white
Light distribution	120°x120° with diffusing glass
Luminaire efficacy	138 lm/W
Luminous flux	5810 lm
Colour rendering	≥ 80
Colour temperature	6500 K
Ambient Conditions	
Ambient temperature	-40 °C ... +55 °C Note: Through wiring Max. 3x16 A -40 °C ... +60 °C Note: Through wiring 2 Max. 3x10 A
Note	Through wiring max. 3x16 A Ambient temperature °C -40 °C ... +55 °C Through wiring 2 max. 3x10 A Ambient temperature °C 2 -40 ... +60 °C
Mechanical Data	
Version	Standard
IP degree of protection (IEC 60598)	IP66/IP67
Class	I (with inner PE connection)
Enclosure material	Polyester resin, Glass fibre reinforced

Lighting

Linear luminaire With LED

GRP industrial design

L402/4348-6100-152-1110-11-8650 Art. No. 272002



Mechanical Data

Enclosure colour	Light grey (RAL 7035)
Diffuser	With diffuser
Sealing material	Silicone
Silicone-free content	Contains silicone
Translucent cover material	Polycarbonate
Installed terminal strip	PE + N + L1 + L2 + L3
Max. solid connection terminals	6 mm ²
Max. finely stranded connection terminals	4 mm ²
Type of connection cable	Finely stranded Solid
Size	4
Width	184 mm
Height	125 mm
Length	1310 mm
Impact strength (IEC 62262)	IK10
Weight	5.6 kg
Weight	12.35 lb
Disconnection of the luminaire	No

Components

Threaded plate	2x plastic
Ballast	VG Luxtronic 40 W 300 mA
Through wiring	With 5 conductors 2.5 mm ²
Drilled holes	3 x M25
Cable glands and entries	2 x M25 Ø 7 ...
Material cable gland	Polyamide, black
Stopping plugs	2 x M25 x 1.5
Stopping plug material	Polyamide, black
Accessories	Provided

Light Distribution Curves

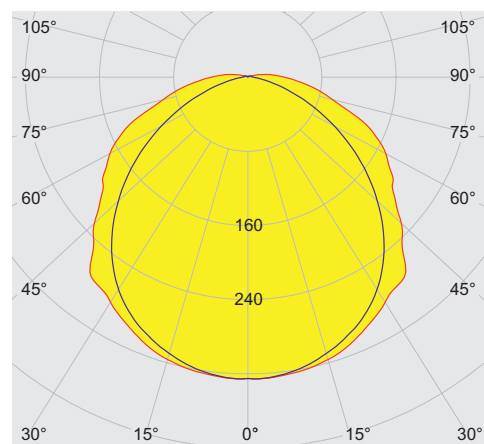

cd/klm 100%
— C0 - C180 — C90 - C270
typical with diffuser, clear translucent cover

Lighting

Linear luminaire With LED

GRP industrial design

L402/4348-6100-152-1110-11-8650 Art. No. 272002



Dimensional Drawings (All Dimensions in mm [inches]) – Subject to Alterations

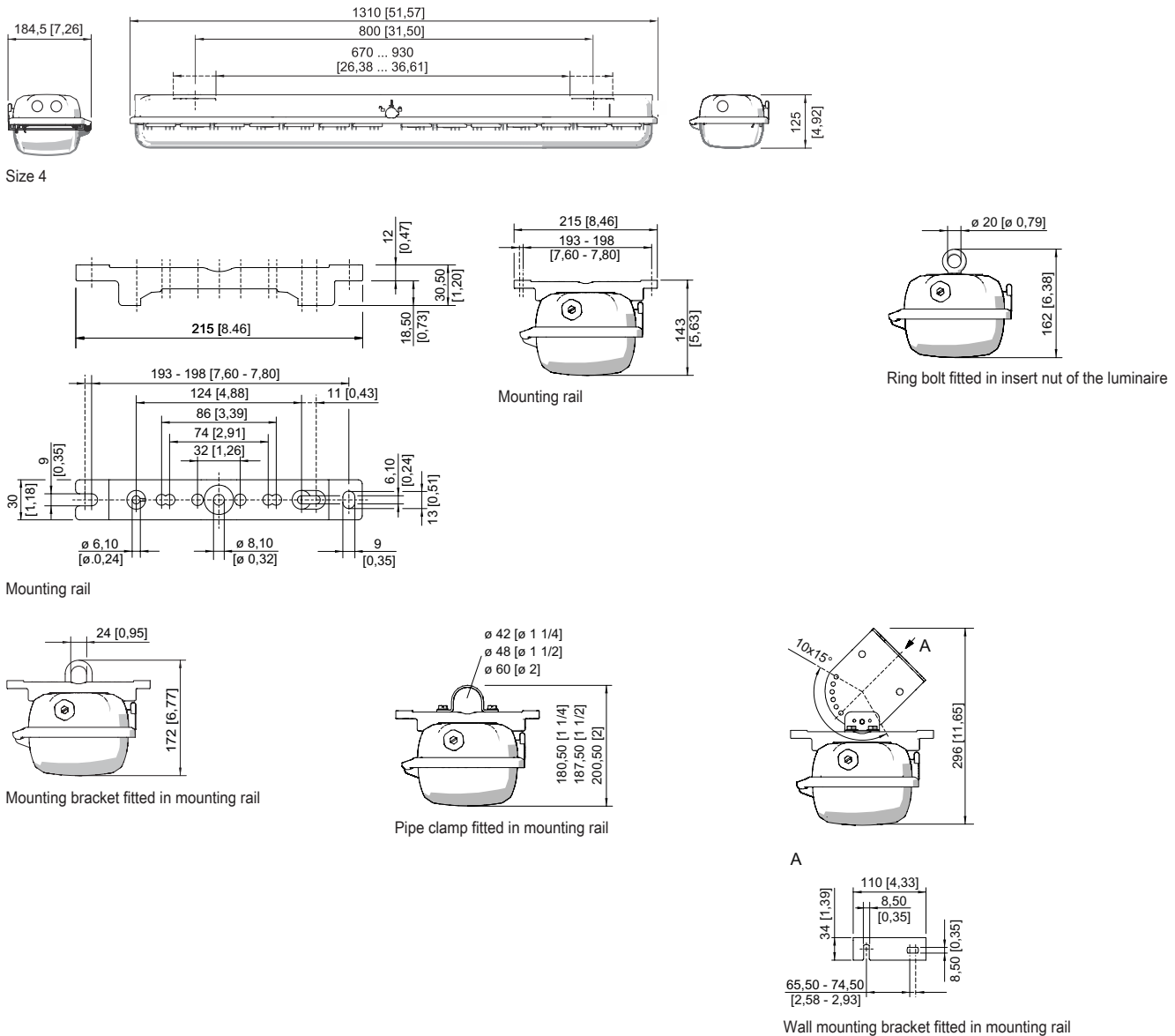

Accessories

Breather

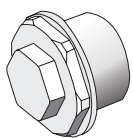

Thread: M25 x 1.5 (1 piece); for installation in light fittings; made from stainless steel; without jam nut

Art. No.

296608

Ceiling and wall mounting bracket

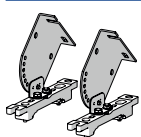

mounted on a mounting rail for a variable mounting distance; Material: stainless steel; Lamp can be swiveled in steps of 15°; 1 pair

Art. No.

222827





Lighting

Linear luminaire With LED

GRP industrial design

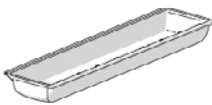
L402/4348-6100-152-1110-11-8650 Art. No. 272002

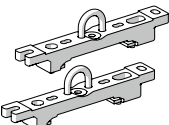
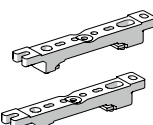
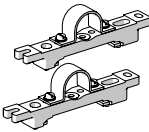
STAHL

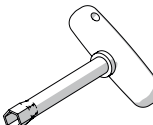
Cover		Art. No.
	For size 4 luminaires (diffuse), when used on an emergency luminaire with individual power supply, the visibility of the display LED may be restricted	276670
Holder for translucent cover		Art. No.
	The fall prevention system for the light fitting cover prevents the light fitting cover from falling accidentally when the light fitting is opened.	226791
Mounting bracket		Art. No.
	mounting clamp mounted on a mounting rail for a variable mounting distance; 1 pair	222456
Mounting rail		Art. No.
	for a variable mounting distance; 1 pair	222826
Pipe clamp		Art. No.
	R 1 1/2"; with mounting rail for a variable mounting distance; material: stainless steel; 1 pair	222459
	R 1 1/4"; with mounting rail for a variable mounting distance; Material: stainless steel; 1 pair	222458
	R 2"; with mounting rail for a variable mounting distance; Material: stainless steel; 1 pair	222460
Pole mounting sleeve		Art. No.
	for the subsequent mounting on lights size 2 and size 4, completely with assembly parts (for pipe diameter 42 mm)	227512
Ring bolt		Art. No.
	M8, direct mounting in insert nuts; 1 pair	115736
Socket key		Art. No.
	M8 / A/F 13; For actuating the central lock	222430

Spare Parts

Cover	Art. No.
-------	----------

Lighting

Linear luminaire With LED

GRP industrial design

L402/4348-6100-152-1110-11-8650 Art. No. 272002

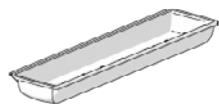

for luminaire size 4

222428

We reserve the right to make alterations to the technical data, dimensions, weights, designs and products available without notice. The illustrations cannot be considered binding.