

6036/1212-453-0181-11 Art. No. 274313



- Degree of protection IP66 and IP68
- Type of protection Ex d
- Vibration-resistant, lightweight, robust (impact strength rating of IK10) and maintenance-free
- Many light fittings can be connected to single miniature circuit breaker due to incredibly low start-up current

MY R. STAHL 6036B



The 6036 series compact LED tubular light fitting is ideal for general lighting applications and for use as machine lighting, even in relatively inaccessible places with very little space. This light boasts a long service life of up to 100,000 hours thanks to its use of energy-efficient LED technology, coupled with electronics that have been developed in-house by R. STAHL. Due to its robust construction, it can withstand extreme temperatures of between -55 °C and +60 °C.

Technical Data

Explosion Protection

Application range (zones)	1 2 21 22
IECEX gas certificate	IECEX EPS 13.0027
IECEX gas explosion protection	Ex db op is IIC T4 Gb
IECEX dust certificate	IECEX EPS 13.0027
IECEX dust explosion protection	Ex tb IIIC T100 °C Db
ATEX gas certificate	EPS 13 ATEX 1 597
ATEX gas explosion protection	Ex II 2 G Ex db op is IIC T4 Gb
ATEX dust certificate	EPS 13 ATEX 1 597
ATEX dust explosion protection	Ex II 2 D Ex tb IIIC T100 °C Db
Certificates and approvals	ATEX IECEX ship approval (DNV GL)
Certificates	ATEX (BVIS), IECEX (BVIS)

Electrical Data

Rated operational voltage AC	24 – 48 V
Rated operational voltage DC	24 ... 48 V
Frequency range	50 – 60 Hz

Lighting Data

Number of lamps	1
Lamp wattage	13 W
Lamp	Single-row LED
Light colour	Neutral white
Light distribution	with diffuser
Luminaire efficacy	104 lm/W

6036/1212-453-0181-11 Art. No. 274313

Lighting Data

Luminous flux	1396 lm
Colour rendering	≥ 80
Colour temperature	5000 K
Note	Values apply to $T_a = +25\text{ °C}$

Ambient Conditions

Ambient temperature	-40 °C ... +70 °C
Storage temperature	-40 °C ... +70 °C

Mechanical Data

Version	Size 1
Degree of protection (IP)	IP66 / IP67
IP degree of protection (IEC 60598)	IP66 / IP68 (10 m / 60 min)
Class	II (double insulated)
Enclosure material	Polycarbonate
Silicone-free content	Silicone-free
Pipe material	Polycarbonate
Type of connection cable	H07RN8-F 2x1.5 mm ²
Cable length	20 m
Size	1
Width	54 mm
Height	54 mm
Length	444 mm
Diameter	54 mm
Impact strength (IEC 62262)	IK10
Weight	3.19 kg
Weight	7.03 lb

Components

Ballast	LED, CSS
Wire guard	No

Technical Drawings – Subject to Alterations

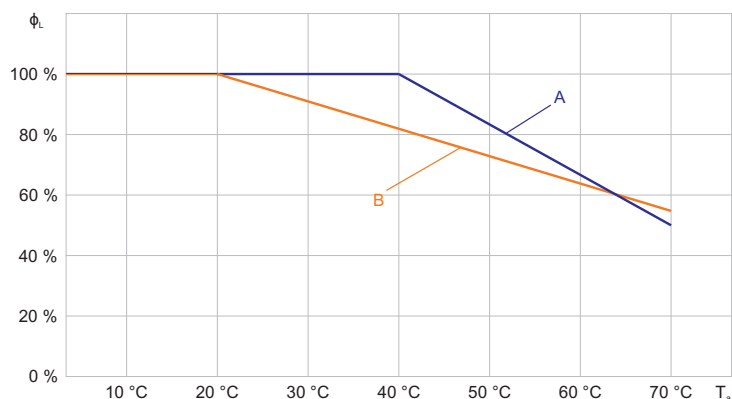

Luminous flux decline relative to ambient temperature

A: Size 1 (110 to 240 V)

B: Size 1 (24 to 48 V)

6036/1212-453-0181-11 Art. No. 274313



Luminous flux decline relative to ambient temperature
 A: Size 2
 B: Size 3
 C: Size 4

Light Distribution Curves



Dimensional Drawings (All Dimensions in mm [inches]) – Subject to Alterations

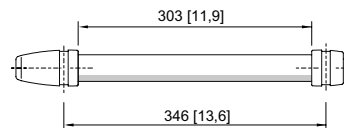
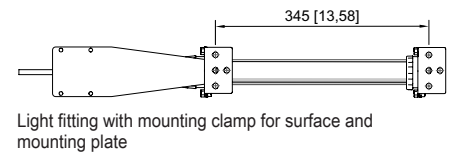
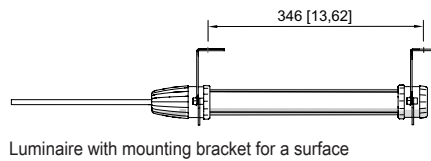

Design size 1

6036/1212-453-0181-11 Art. No. 274313

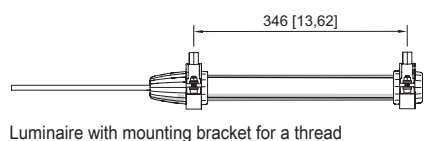

Luminaire with mounting bracket for a thread

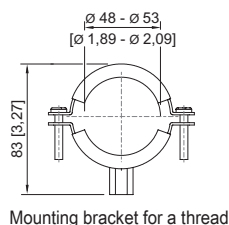
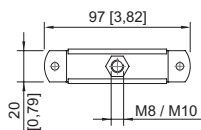

Mounting bracket for a thread

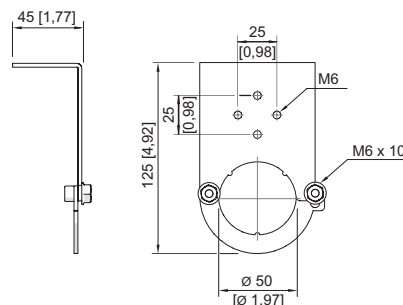
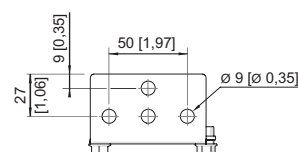





Mounting bracket for surfaces



Mounting plate

Accessories

Plug		Art. No.
	8573/12-200 2-pole, 20 to 25 V, 50 / 60 Hz, 16 A	243197
	8573/12-210 2-pole, 20 to 25 V, DC, 16 A	243203
	8573/12-300 3-pole, 20 to 25 V, 50 / 60 Hz, 16 A	243190
	8573/12-312 3-pole, 40 to 50 V, 50 / 60 Hz, 16 A	243195
	8570/12-304-S-XX-X-XX-XXX 3-pole plug, 100 to 130 V AC, 50/60 Hz, 16 A	272896
	8570/12-306-S-XX-X-XX-XXX 3-pole plug, 200 to 250 V AC, 50 / 60 Hz, 16 A	272898

6036/1212-453-0181-11 Art. No. 274313

Mounting bracket		Art. No.
	Mounting bracket made of galvanized sheet steel to screw onto thread M8 or M10 (2 pieces)	227256
	Mounting bracket made of stainless steel V4A to screw onto thread M8 or M10 (2 pieces)	227257
	Double plastic mounting clamp for mounting on pipes with a diameter of 45 to 55 mm (screws and nuts made from stainless steel V2A) (2 pieces)	254932
	Set of mounting plate Art. no. 254494 and mounting bracket Art. no. 252940	248100
	Mounting bracket made of stainless steel V4A for fastening on surfaces (2 pieces)	252940
	Mounting bracket made from galvanized sheet steel (x 2 units); for design size 1	120535
	Mounting plate made of stainless steel V4A for terminal box Ex e Series 8010 (for example Art. No. 130724) for fastening on mounting bracket Art. No. 252940	254494
Mounting bracket and magnet		Art. No.
	Mounting bracket made from galvanized sheet steel with magnetic base (x 2 units); for design size 1	120536

We reserve the right to make alterations to the technical data, dimensions, weights, designs and products available without notice. The illustrations cannot be considered binding.