

8595/1-PB1-S-P05-001 Art. No. 298963



- Simple handling using hot swap technology
- Versatile application possibilities thanks to modular structure
- Most extreme operating conditions in hazardous areas
- Reliable data and signal connections or power supplies
- Simple connection and disconnection thanks to one-handed operation

MY R. STAHL 8595B



R. STAHL's Series 8595/1 explosion-protected miniCON plug connectors with up to eight poles keep you safely connected. The high-quality plastic or stainless steel plug connectors have impressed many customers with their reliability and versatility in application. Their hot swap disconnecting capacity means that intrinsically safe signal supplies and power supplies up to 500 V/16 A can be connected and disconnected reliably and safely without the need for a hot work permit or other hot work authorisation. The miniCON connectors designed for conductor cross-sections of 0.25 mm² to 2.5 mm² are available for directly connecting electrical lines or for device installation in the device plug and flange socket types of construction. The new plug connectors for hazardous areas in Zones 1 and 21 stand out from the competition thanks to their modular structure and logically arranged components, which enable quick, easy mounting. Our patented single-handed operation means that matching plug connectors, which can be defined by the installer using internal coding for up to three applications, can be connected in no time.

Technical Data

Explosion Protection

Scope of validity	European Union (ATEX) IECEX
Application range (Zones)	1 2 21 22
IECEX gas certificate	IECEX EPS 20.0035X
IECEX gas explosion protection	Ex db eb IIC T6 / T5 Gb
IECEX gas explosion protection 2	Ex ia IIC T6 Ga
IECEX dust certificate	IECEX EPS 20.0035X
IECEX dust explosion protection	Ex tb IIIC T80 °C / T95 °C Db
IECEX dust explosion protection 2	Ex ia IIIC T80 °C Da
ATEX gas certificate	EPS 20 ATEX 1075 X
ATEX gas explosion protection	⊕ II 2 G Ex db eb IIC T6 / T5 Gb
ATEX gas explosion protection 2	⊕ II 1 G Ex ia IIC T6 Ga
ATEX dust certificate	EPS 20 ATEX 1075 X
ATEX dust explosion protection	⊕ II 2 D Ex tb IIIC T80 °C / T95 °C Db
ATEX dust explosion protection 2	⊕ II 1 D Ex ia IIIC T80 °C Da
Certificates	ATEX (EPS), IECEX (EPS)
Declaration of Conformity	ATEX (EUK)

Installation equipment

miniCON plug connector



8595/1-PB1-S-P05-001 Art. No. 298963

Electrical Data

Rated operational voltage AC	500 V
Rated operational voltage DC	max. 110 V
Voltage tolerance	+10%
Rated insulation voltage	690 V
Rated operational current for AC	16 A
Rated operational current for DC	8 A
Rated operational current for DC 2	16 A
No. of poles	7 P + PE / 8 P
No. of poles note	Eight contacts are included in the delivery as standard. One to eight contacts can be used.
AC frequency range	50 – 60 Hz

Device Specific Data

Back-up fuse with thermal protection	25 A GL
Back-up fuse without thermal protection	16 A GL

Ambient Conditions

Ambient temperature °C	-60 °C ... +75 °C
Ambient temperature °F	-76 °F ... +167 °F

Mechanical Data

Version	Plug
Degree of protection (IP) (IEC 60529)	IP66 IP67
IP degree of protection (IEC 60079)	IP64
Base part	Plug
Enclosure material	Nickel-plated brass
Contact type	Pin contact
Connection cross-section	0.5 mm ²
Connection cross-section 2	0.25 mm ²
Connection cross-section AWG	AWG20
Connection cross-section AWG2	AWG24
Connection thread	M20 x 1.5
Impact strength (IEC 60079)	7 J
Coding	1-3, arbitrary
Seal	Silicone
Weight	491 g
Weight	1.08 lb

Mounting / Installation

Connection type	crimp
Connection type 2	solder

Components

Protective cap available	Yes
--------------------------	-----

8595/1-PB1-S-P05-001 Art. No. 298963

Technical Drawings – Subject to Alterations

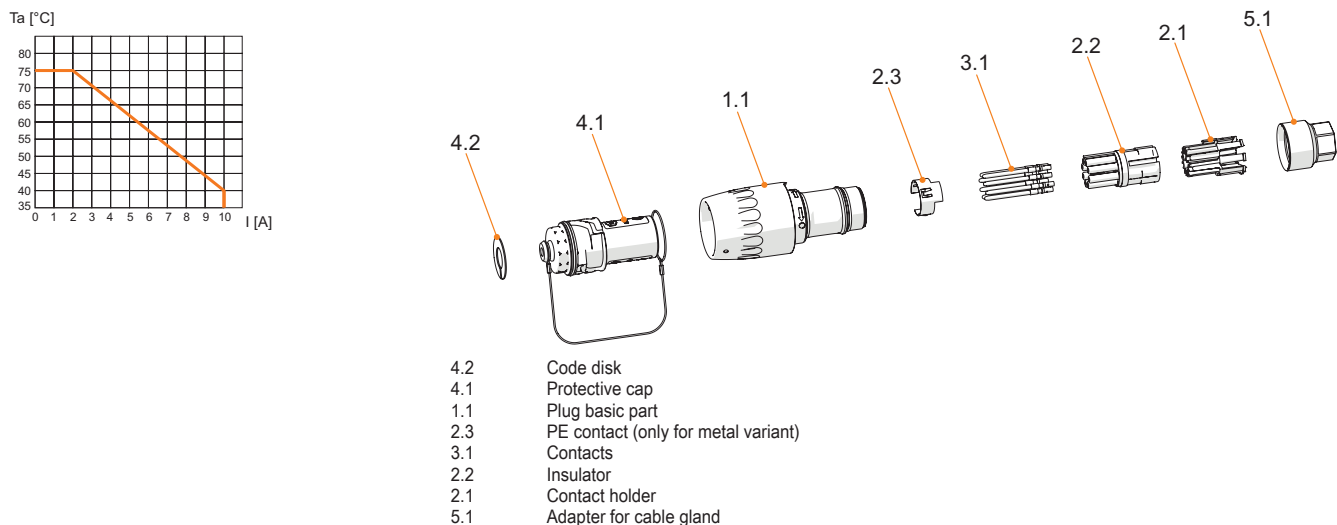

Dimensional Drawings (All Dimensions in mm [inches]) – Subject to Alterations

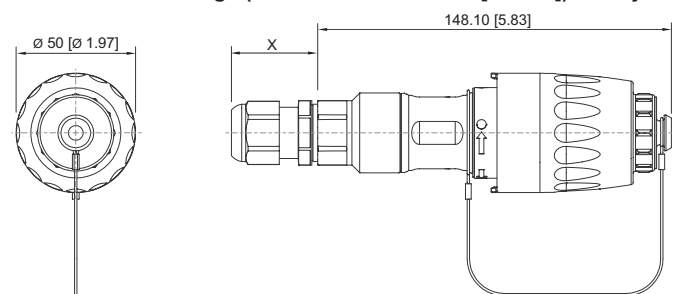

8595/1 plug
X = depending on the cable gland used

Accessories

		Art. No.
Adaptor		
	8595 nickel-plated brass adaptor for cable gland, M16 x 1.5	314522
Coupling		
	Enclosure material: Nickel-plated brass Contact type: Socket contact Connection cross-section: 0.5 mm ² Number of poles: 7 P + PE/8 P Connection type: Crimping	298975
	Enclosure material: Plastic Contact type: Socket contact Connection cross-section: 0.5 mm ² Number of poles: 7 P + PE/8 P Connection type: Crimping	286556

Installation equipment

miniCON plug connector



8595/1-PB1-S-P05-001 Art. No. 298963

Ex e flange socket

Art. No.



Enclosure material: Nickel-plated brass
 Contact type: Socket contact
 Connection cross-section: 0.5 mm²
 Number of poles: 7 P + PE/8 P
 Connection type: Crimping

298977

Crimping tool

Art. No.

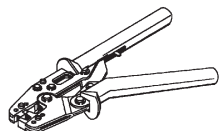

For all versions with crimp connection of 0.14 to 6 mm²

295689

Contact mounts/positioners for rotated industrial contacts

Art. No.

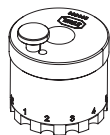

The selection of the contact mount is based on the crimp contacts to be processed.
 - Exact positioning of the crimp contact during the crimping process
 - Reliable, reproducible crimping result
 - Adapted for miniCON contacts

299586

2-ear clamps

Art. No.

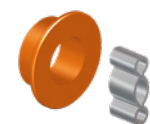

KIT 8595 2-ear clamps, small
 Strain relief depending on the cable gland used
 Cable outer diameter 5 to 13 mm

286168

Adaptor

Art. No.



KIT 8595 nickel-plated brass adaptor
 for cable gland, M20 x 1.5

296752

Pin contact

Art. No.



KIT 8595 pin contacts (0.25 to 0.5 mm²), 8 pieces

286155

Code disks

Art. No.



KIT coding plate 8595, four colours, without labelling
 Customer-specific labelling available on request

289939

Metal cable gland

Art. No.



CMP type 20C2K, Ex e
 Nickel-plated brass, M20 x 1.5, for armoured cables, thread length 10 mm
 Cable outer diameter 12.5 to 20.9 mm

309134

CMP type 20s/16C2K, Ex e
 Nickel-plated brass, M20 x 1.5, for armoured cables, thread length 10 mm
 Cable outer diameter 9.5 to 15.9 mm

309133



CMP type 20sC2K, Ex e
 Nickel-plated brass, M20 x 1.5, for armoured cables, thread length 10 mm
 Cable outer diameter 9.5 to 15.9 mm

313014

8595/1-PB1-S-P05-001 Art. No. 298963

	CMP type 20A2e100, Ex e Nickel-plated brass, M20 x 1.5, for unarmoured cables Cable outer diameter 7 to 13.5 mm	309137
	CMP type 20s/16A2e100, Ex e Nickel-plated brass, M20 x 1.5, for unarmoured cables Cable outer diameter 3.2 to 8 mm	309136

Spare Parts

Jam nut, nickel-plated brass (-60 to +75 °C) To mount the cable entries in the through holes		Art. No.
	Material: Nickel-plated brass One piece Thread size: M32	110869
Contact holder for pin contact		Art. No.
	KIT 8595 pin contact insert + PE	286148
Protective cap		Art. No.
	KIT 8595 plug protective cap (pin/socket) Incl. KIT 8595 coding plates, four colours, without labelling	286161

We reserve the right to make alterations to the technical data, dimensions, weights, designs and products available without notice. The illustrations cannot be considered binding.