

DIALux

Version 4.9

The Software Standard for
Calculating Lighting Layouts



User Manual

© 2011 DIAL GmbH
Gustav-Adolf-Straße 4
58507 Lüdenscheid
dialog@dial.de
www.dial.de

16th Edition 2011

The text and images were prepared with great care. DIAL, the authors and the translators are, however, not subject to legal obligation or liability for any erroneous information and its consequences.

This publication is protected by copyright law. All rights are reserved. Most of the soft-ware and hardware designations used in this manual are registered trademarks and therefore subject to the applicable laws.

The DIAL GmbH can not be held responsible for any damage to people or property which might occur in connection with the use of the DIALux software. The program and documentation was created with great care, however errors cannot be ruled out.

POV-Ray™

POV-Ray™ is short for the Persistence of Vision™ Raytracer, a tool for producing high-quality computer graphics. POV-Ray™ is copyrighted freeware, that is to say, we, the authors, retain all rights and copyright over the program, but that we permit you to use it for no charge, subject to the conditions stated in our license. You can read the license by viewing the POV-Ray for Windows About box by using the Help menu or Alt+B and selecting the appropriate button.

CONTACT INFORMATION for POV-Ray™

License inquiries can be made via email; please check the POV-Ray™ website and the online copy of this document at <http://www.povray.org/povlegal.html> for the current email address of the team leader. (Unfortunately we cannot include it here as we have to change it from time to time due to spam email being sent to the address).

The following postal address is only to be used for official license business when emailing is impossible.

We do not provide technical support. We will not mail you disks with updated versions. Please do not send money. If you want to know how to support us, please see <http://www.povray.org/supporting-povray.html>.

POV-Team
C/O Hallam Oaks P/L
PO Box 407
Williamstown,
Victoria 3016
Australia

MESA Copyright (C) 1999-2003 Brian Paul All Rights Reserved.
THE SOFTWARE IS PROVIDED "AS IS", WITHOUT WARRANTY OF ANY KIND, EXPRESS OR IMPLIED, INCLUDING BUT NOT LIMITED TO THE WARRANTIES OF MERCHANTABILITY, FITNESS FOR A PARTICULAR PURPOSE AND NONINFRINGEMENT. IN NO EVENT SHALL BRIAN PAUL BE LIABLE FOR ANY CLAIM, DAMAGES OR OTHER LIABILITY, WHETHER IN AN ACTION OF CONTRACT, TORT OR OTHERWISE, ARISING FROM, OUT OF OR IN CONNECTION WITH THE SOFTWARE OR THE USE OR OTHER DEALINGS IN THE SOFTWARE.

Registered Trademarks:

Microsoft, MS, Windows, Windows NT, Win32 are registered trademarks of the Microsoft Corporation in the USA and other countries.

Adobe, Acrobat Reader are registered trademarks of Adobe Systems, INC.

"POV-Ray™", "Persistence of Vision", "POV-Team™" and "POV-Help" are trademarks of the POV-Team™. Any other trademarks referred to herein are the property of their respective holders.

DIALux Version 4.9

The Software Standard for Calculating Lighting Layouts

Function Overview

Welcome to DIALux 4.9

This manual is intended to assist you to work fast and effectively with DIALux. If you have experience with Windows applications, getting started in DIALux will present no problem. DIAL regularly offer courses where the professional use of DIALux can be learned. Information regarding the course dates and contents are available under www.dialux.com and www.dial.de or +49 (0) 2351 1064 360. Latest information and updates are also available on our homepage.

In the following you will find a short description of the functions available in DIALux.

DIALux offers a number of textures that you are free to use for your lighting layouts. The following companies provided those textures:

- Texturenliste SuperFinish – Immobiliendarstellungen, Jochen Schroeder/ www.immobiliendarstellung.de
- Arroway Texturen/ www.arroway.de
- Ulf Theis/ www.ulf-theis.de
- Texturenland (Konstantin Gross)/ www.texturenland.de
- Noctua Graphics (Herbert Fahrholz)/ www.noctua-graphics.de
- Thermopal/ www.thermopal.de
- Rathscheck Schiefer und Dachsysteme KG/ www.rathscheck.de

They offer many more textures. Check their websites for further textures.

Contents

Contents	4
New functions in DIALux Version 4.9	10
New features and improvements	10
Changes in existing functionality	11
Installation	12
Installation after Internet Download	12
Installation from CD	13
Online Menu	14
Online Update	14
Manage Newsletter subscription	14
Wishes and Feedback / Send problem report	14
Install Luminaire Data	15
About PlugIns	15
Online update of luminaire catalogues	15
About Online Catalogues	16
Lamp PlugIns	16
DIALux directories	17
Background information	17
Furniture, textures, my database	17
Windows Vista	17
Projects and raytracing files	17
Windows Vista	17
Program files, support	18
Windows 2000, XP, Vista	18
Common used program files (DIALux, PlugIns)	18
Windows 2000, XP, Vista	18
DIALux Light	19
Working with Wizards	25
The DIALux User Interface	34
The Project manager	38
The Luminaire Selection	39
The User Database	40
Insert Luminaire Files into DIALux	40
Lamp PlugIns	41
The Furniture Tree	44
The Colours Tree (since version 4.3, formerly Texture Tree)	44
The Output Tree	46
The Guide	47
The Inspector	48
Edit Mode	50
Optimise Personal Settings	54
General Options	54
Direct3D as an alternative to OpenGL	56
Create a New Project	61
Open a new project	62
Project information in the file open dialog	63
Edit Rooms	64
Edit Room Geometry	64
Edit Room Data	65
An easy method for determining maintenance factor	66

Extended method for determining maintenance factor	68
Modify Properties of Individual Walls	76
Insert Room Elements	78
Modify a Room with Room Elements	78
Vault and half vault	81
Insert via Property Page	81
Insert Furniture	82
Insert Furniture	82
Insert via Property Page	82
Create Furniture	82
Import Furniture and 3D model Files	85
Extrusion Volumes	86
Glass objects	87
Subtraction of Objects	88
Selecting Single Surfaces	89
Windows and Doors	90
Decoration Objects	90
Insert Decoration Objects	91
Calculate with Decoration Objects	92
Insert Textures	93
Insert via Drag & Drop	93
Edit Placed Textures	93
Delete Textures	94
Import Textures into the Texture Tree	94
Edit Room Geometry with DWG or DXF-File	95
Material dialogue for surfaces	96
Colour	96
Reflection (Rho)	96
Transparency	96
Calculation of transparency	97
Roughness	97
Mirror effect	97
Material	97
Raytrace preview	97
Duplicate (Copy Rooms/Scenes/Streets)	100
Duplicate an Existing Room	100
Insert and Edit Luminaires and Luminaire Arrangements	101
Online Catalogues	102
Individual Luminaires	102
Aligning Luminaires	105
Inserting Luminaire Fields	107
Inserting Luminaire Lines	111
Aligning Lights	113
Inserting Luminaire Circles	113
Separating Luminaire Arrangements	114
Floodlighting	114
Inserting floodlight illumination	114
Arranging floodlighting	116
Focal points	116
Modify the position of a Luminaire	118
Luminaires with articulated joints	119
Luminaires with several articulated joints	120

Unrestricted lighting arrangements	120
Aligning luminaire arrangements	122
Calculation of luminaire geometry included	123
Illumination strategies	124
Insertion of luminaires with "direct planar lighting"	124
Insertion of luminaires with "vertical planar lighting"	127
Coloured light	130
Background information	130
Lamp spectrum / Light colours	131
Colour filters.....	136
Coaction of spectral distribution of the light source and colour filter	137
Light colours in the ray tracing	138
White balance	138
Light Scenes and Control Groups	140
Definition	140
Requirements	140
Generate a project with light scenes and control groups.....	140
Modify light scenes and control groups.....	147
Export of light scenes.....	149
Emergency lighting.....	150
Global	150
Escape route lighting	152
Open area lighting (anti panic).....	154
High risk task area lighting.....	157
Luminaires with emergency lights	157
Emergency lighting data sheet	158
Daylight calculation in DIALux	159
Basics	159
Sky types in DIALux.....	159
Light Scenes	160
Daylight calculation	161
Obstruction	163
Sun and shadow visualisation	164
Settings in the calculation dialogue.....	164
Working in the 3D View	166
Setup the 3D View.....	166
Check Calculation Values in the 3D View.....	167
Save 3D View	168
Presentation of false colour rendering.....	170
Working in Various Views.....	171
Save 3D CAD views	172
Wireframe Model	174
Editing Inserted Objects.....	175
Moving Objects	175
Fading out objects	176
Moving and Rotating Objects without Pick Grid	177
Scale or rotate	179
Rotating Objects	179
Scaling Objects	180
Combining and Saving Objects	180

Moving the Coordinate Origin of an Object	181
Resetting the rotation of the origin	182
Editing Object Surfaces	182
Arrangement aids.....	185
Measurement of distances	185
Working with the snap grid	186
Automatic help lines	186
Helping areas defined in the ruler	187
Working with help lines	188
Simple help lines.....	189
Poly help lines.....	190
Spline help line	191
Circular help line.....	192
Help grids	193
Copy and paste with CTRL+C, CTRL+V and CTRL+H	195
Copy Along a Line	195
Align and distribute	196
Centre objects in the room	197
Calculation Surfaces and other Calculation Objects ...	198
Calculation Surfaces	198
Calculation surfaces for different types of illuminance	199
Penetration.....	199
Task Areas	200
Calculation grids.....	200
Editing.....	202
Scaling.....	204
Merging calculation grids.....	205
Calculation points in calculation grids	205
Measuring grids.....	207
Calculation	208
Gradients.....	209
Display settings.....	210
Real time calculation.....	210
Isolines	212
Calculation Points.....	213
UGR Calculation	214
Insert UGR Calculation Point and UGR Calculation Area	214
Adjust Viewing Direction of UGR Observer and UGR Area	215
Exterior Lighting	216
Exterior Scenes	216
Ground Elements.....	217
Floodlight Illumination	218
Lighting Design according to prEN12464 Part 2 / EN8995-2.....	219
Glare Rating	219
Obtrusive Light / ULR Calculation	220
Obtrusive Light / Luminous Intensity Calculation Point	221
Street Valuation Fields in Exterior Scenes	222
Road lighting.....	224

Standard Streets	224
Planning with standards.....	225
Street Planning without Wizard	227
Quick Street Planning Wizard.....	242
Optimised Street Light Arrangement Wizard	249
Illumination Conditions Wizard according to CIE 140 / EN 13201	252
Illumination Class Wizard according to CIE 140 / EN 13201	254
Importing R-tables	260
Sports complexes	262
Inserting a sports complex	262
Editing a sports complex	263
Flood light table for sport complex lighting	264
Initial calculation grids	266
Pole positions	266
TV cameras.....	266
Outputs.....	267
Global Output Settings.....	269
User Data and Project Data.....	269
Global Settings	270
Output.....	271
Viewing Calculation Results	271
Limit Result Output.....	272
Output Settings	273
New Output in DIALux.....	274
Luminaire Data Sheet.....	275
Luminance Diagram.....	275
Tabular Presentation of Photometric Data of Luminaires.....	276
Tabular Presentation of Exterior Scenes.....	276
Creating User-Defined Standard Output	277
Save Output as PDF-File	278
Export Output Graphics, tables, text and graphic ...	279
DWG and DXF Import and Export.....	281
DWG / DXF-Import	281
Basic DWG / DXF Settings and Layer Selection	281
Edit a Room based on the DWG / DXF-Ground Plan	282
Working with the DWG / DXF Background in the 3D View.....	283
DWG / DXF-Export.....	284
gbXML file import	290
Importing gbXML	290
Working with gbXML files	290
STF Interface	291
Energy Performance of Buildings	292
Background information	292
Why energy evaluation in DIALux?	293
Structure of an energy evaluation project.....	294
Energy evaluation rooms with and without links to DIALux rooms.....	298
Working on parameters	302
Calculation and results.....	304

Documentation of energy evaluation results	307
Making videos in DIALux	309
Raytracer	313
Background	313
POV-Ray Settings within DIALux	313
Photo Realistic Images with Raytracing	313
Basic Settings	313
Quick preferences	314
Image preferences	316
Indirect calculation	316
Brightness preferences	318
Raytracing-Options for Surfaces	319
3-D Standard View for Raytracing	320
Starting POV-Ray	320
Manipulation of the POV file and editing in POV-Ray	322
Start of the adapted POV-Ray Version	322
Smoothing edges	322
Picture ratio	323
Camera	325
Animation	327
Animation with Keyframes	327
Translation animation	330
Colour	332
Further functions of POV-Ray	332
List of figures	339
Index	351
Appendix A Keyboard Short Cuts	354

New functions in DIALux Version 4.9

The DIALux version 4.9 has the following new features:

New features and improvements

- **[Streetlight Calculation according to US-Standard IESNA RP-08-00](#)**
DIALux includes up to Version 4.9 the streetlight calculation according to the American standard IESNA RP-08-00. With the streetlight calculation it is now possible to switch between the European standard CIE 140 / EN 13201 and the US standard RP-08-00.
- **[Output of the Australian standard IEQ-7](#)**
In the output you can find a specification to Australian standard IEQ-7. By setting the checkbox into the general options from DIALux it is displayed announce in the output.
- **[gbXML file import](#)**
DIALux is capable to import gbXML files. This data type provides that building information like windows, doors etc. send directly to DIALux without putting the objects later in the building.
- **[CSV Export](#)**
Additional to the already known features in DIALux Version 4.9 it is capable to export csv file. The streetlight wizard is able to export the file with the list of positioning suggestions and to save this as a csv file. This list can be open for example with Excel.
- **[Save settings at Quick Street Planning wizard and Optimised Street Light Arrangement wizard](#)**
In these wizards you can save set values for further optimisations.
- **[Flood light table for sport complex lighting](#)**
A new function for the lighting at the sports complex building is the possibility to work with tables. It simplifies the positioning of luminaire in sports complexes.

- **Fading out objects**
Via the context menu objects can fade out and in.
- **LDC rotation**
To conform the American standard to the European standard it is possible in DIALux 4.9 to rotate the LDC 90°.

Changes in existing functionality

- **Luminaires selection at Quick Street Planning wizard and Optimised Street Light Arrangement wizard**
The luminaire selection in these wizards has been improved. At the luminaire selection you are able to select several luminaires.
- **Inclination of luminaires at the wizards**
DIALux 4.9 permits to assign every luminaire an angle of inclination in the street light wizards.
- **Various translations**
At various passages the translation of DIALux manual has been reworked.
- **Various bug fixes**
Due to the strong participation of our users in the DIALux-Forum (www.dialux.com) different smaller bugs in DIALux could have been fixed. Thank you!

Installation

The installation of DIALux is easy to do. Please close all other application programmes before installing DIALux.

Installation after Internet Download

After you have downloaded the DIALux Setup (version no.) .exe from our homepage (www.DIAL.de or www.dialux.com) on your hard-disk, you can start this file by one double-click with the right mouse button. Afterwards you can follow the simple instructions on the screen. The installation program of DIALux may require you to install a newer version of the Microsoft Internet Explorer. Version 5.5 or higher is needed; this can be downloaded from www.microsoft.com. The setup checks automatically which components are needed for your computer and automatically downloads them.

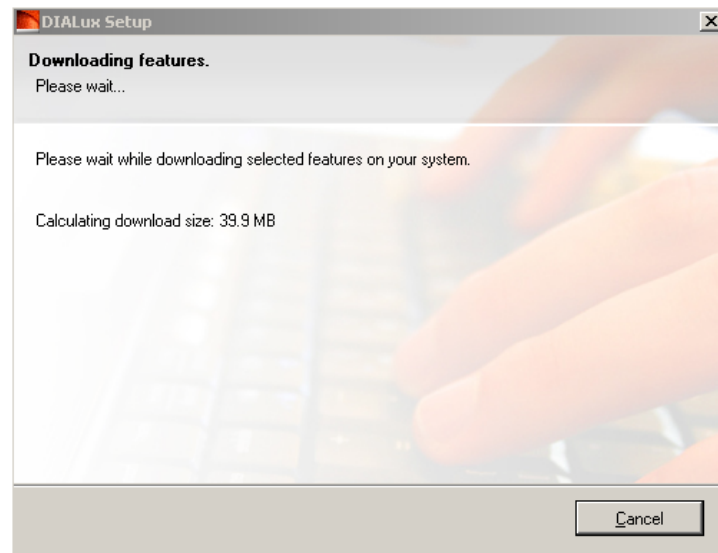

Fig. 1 DIALux Setup

The setup enables you to install only those components you really need. Missing components can be added easily later by starting the setup again.

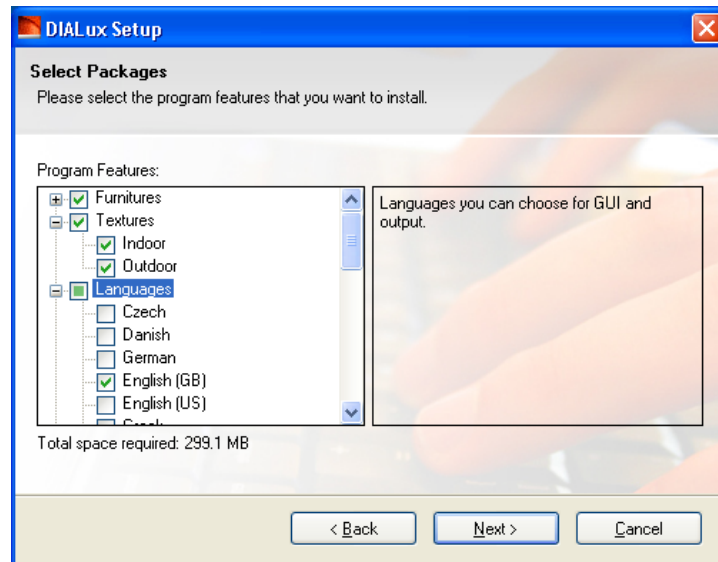

Fig. 2 Selection of the components to be installed

Installation from CD

If you want to install DIALux from our CD, insert the DIALux CD and automatically a welcome screen starts. You can then click on install DIALux. If the installation program finds that your Microsoft Internet Explorer is later than version 5.5, you will be requested to install a newer version.



Fig. 3 DIALux CD browser

Online Menu

Online Update

In DIALux you will find a new menu named "Online".

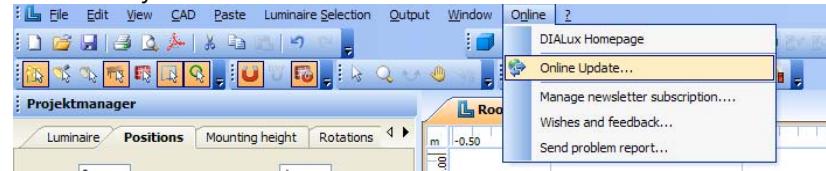

Fig. 4 DIALux online menu

In that new menu there are several useful features listed to contact DIAL. After selecting "Online Update..." DIALux automatically checks for newer versions of the software and for new online PlugIns.

Manage Newsletter subscription

Here you can enter your email address to subscribe (or unsubscribe) to the regular DIALux newsletter. It informs you about new versions and possibilities of DIALux. It is sent out every 6 to 8 weeks.

Wishes and Feedback / Send problem report

Maybe during working with DIALux you consider that an important feature is missing. Click on "wishes and feedback" and tell us what you need.

If a problem or even a crash occurs while using DIALux, click on the "Online" menu and "Send problem report". This will send an email to us that help us to solve the problem and helps you to get a more stable version. After a crash, this dialog opens automatically.

Install Luminaire Data

About PlugIns

DIALux is always delivered without luminaire data. The so-called PlugIns with the luminaire data of the manufacturers are directly available from our project partners. You can download the PlugIns either from the respective homepage of our project partners or you can request a CD with the luminaire data. You will find the appropriate links for our project partners alternatively there are telephone numbers and contact addresses on our homepage www.DIAL.de under *Data PlugIns* or you can click in the luminaire tree of DIALux on a *not installed* manufacturer. Afterwards a window opens, which displays the links of the corresponding manufacturers and contact addresses (see page 39).

After you have downloaded a PlugIn, close DIALux first before starting the PlugIn by one double-click. Then an installation program activates and you can follow the instructions on the screen. After completion of installation you can restart DIALux and in the luminaire tree a new PlugIn is now displayed (see page 39). You can activate the PlugIn by one double-click from DIALux.

If you want to install a PlugIn from a manufacturers CD, close DIALux before proceeding if it is open, then just insert the CD. Under normal conditions automatically a start window opens and you can follow the instructions. If no start window opens, please start the Windows Explorer and select the directory of the PlugIn of the CD. One double-click on the PlugIn opens it and you can follow the simple installation instructions.

Online update of luminaire catalogues

The list of manufacturers which offer luminaire catalogues for DIALux changes constantly. Since DIALux 4.9 you can update the list of PlugIns easily online without the need to install the latest version of DIALux. To proceed with an online update please choose "Luminaire Selection" from the project manager and select either "DIALux Luminaire Catalogues" or "Not Installed Catalogs" by clicking right onto them. Afterwards please choose "Refresh list" from the opening context menu. DIALux asks you thereupon if you agree to connect with the internet. By choosing "Yes" the data on your PC will be updated following.

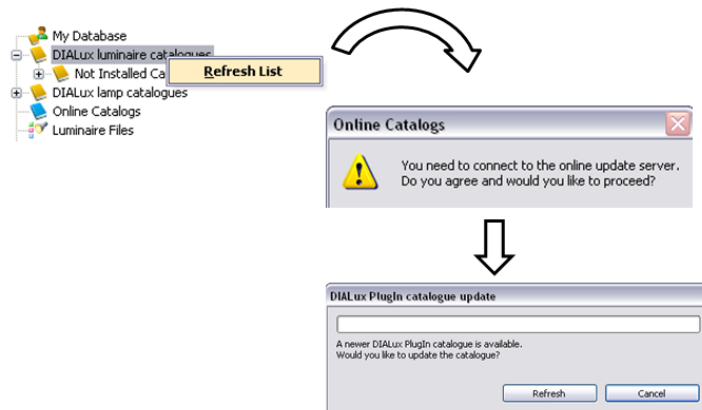

Fig. 5 Online update of luminaire catalogues

About Online Catalogues

DIALux offers the possibility to use online catalogues. Online catalogues have the advantage that you can insert in each case the luminaires, which you need straight into the DIALux project, without installing a complete PlugIn on the PC. Working with online catalogues is described fully on page 102.

Lamp PlugIns

DIALux includes a lamp PlugIn interface. After selecting a luminaire from the luminaire catalogue, you can select the correct lamp for this fitting. Luminaire PlugIns only offer standard equipment data for the luminaires. The numerous variations of the same lamp type makes it absolutely necessary to select the exact lamp type which will be used in the installation. Some of the luminaire PlugIns directly offers the possibility to select the correct lamps from a lamp PlugIn for the desired luminaire. If this feature is not (yet) integrated in the luminaire PlugIn, the lamp PlugIn can be started directly from DIALux. Lamp PlugIns have to be installed by the user like the luminaire PlugIns. DIALux offers for both lamp and luminaire PlugIns some demonstration data in the user database and in the DIALux Demo Lamp database.

DIALux directories

Background information

Microsoft has more and more strictly separated the user and the administrator privileges in Windows Vista and XP. So misuse of the computer by unauthorized persons or by malware was complicated. On the other hand users, administrators and manufacturer of software are more and more forced to follow the guidelines of the operating system strictly. To make sure that also users with restricted privileges can use DIALux with all its features it was necessary to change some directories used by DIALux.

Furniture, textures, my database

These directories are now placed in the "application data common folder". This standard directory can be changed by the administrator. The following examples are standard settings after a windows installation.

Windows XP, Windows 2000

C:\documents and settings\All
Users\application data\DIALux

- Drive is the system drive (standard: C:)
- subdirectory „documents and settings“ is localized, (Standard: „Documents and Settings“)
- subdirectory application data is localised and hidden (Standard: „Application Data“)

Windows Vista

C:\ProgramData\DIALux

- Drive is the systemdrive (standard: C:)
- subdirectory „ProgrammData“ is hidden

Projects and raytracing files

Since DIALux 4.4 the DIALux project files and the raytracing files are stored in the "my documents" folder. This was necessary to make sure, that users with restricted privileges can load and save files.

Windows XP, Windows 2000

C:\documents and settings\“user name” \my
documents\DIALux

- Drive is the system drive (standard: C:)
- subdirectory „my documents “ is localized, (Standard: „my documents“)

Windows Vista

C:\User\“user name”\documents\DIALux

- Drive is the systemdrive (standard: C:)
- subdirectory „user“ is localized

- subdirectory „documents“ is localized

Program files, support

The DIALux directory is placed in the “Program files” folder. This standard directory can be changed by the administrator. The following examples are standard settings after a windows installation.

Windows 2000, XP, Vista

C:\Program files\DIALux

- Drive is the systemdrive (standard: C:)
- subdirectory „program files“ is localized

Common used program files (DIALux, Plugins)

The DIALux directory is placed in the “Program files” folder. This standard directory can be changed by the administrator. The following examples are standard settings after a windows installation.

Windows 2000, XP, Vista

C:\program files\common files\DIALux

- Drive is the systemdrive (standard: C:)
- subdirectory „program files“ is localized

DIALux Light

DIALux Light *Wizard* has been available since DIALux version 3.1. With the help of this wizard it is possible to complete lighting designs quickly and simply. This means that infrequent users of DIALux can readily use the program without having to train themselves fully in using the software.

After the installation you will find the DIALux Light Wizard on your desktop near the "normal" DIALux icon. You can start the wizard by one double-click. If you have already started DIALux, you will find the DIALux Light wizard in the menu *File* → *Wizards*.



Fig. 6 DIALux Light Wizard – DIALux Light icon

After starting DIALux Light you are welcomed by a startup window. In this window the next steps that follow are explained. To move to the next window click on *Next*.

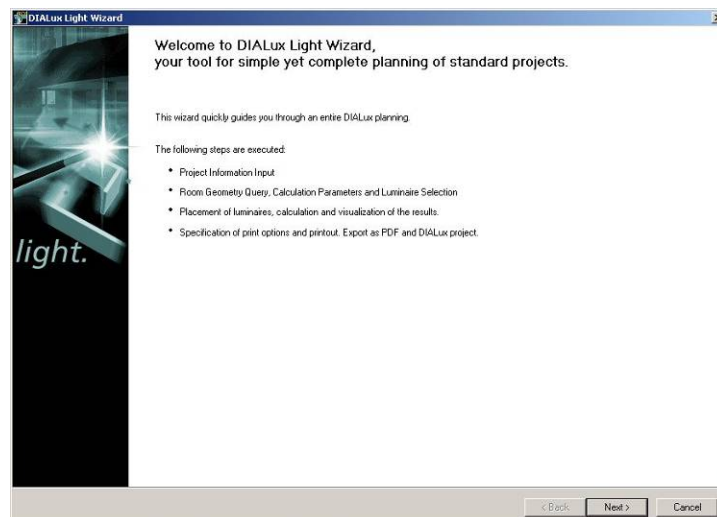

Fig. 7 DIALux Light Wizard – Start

In the window *Project Information* you enter your data and the data of your customer. Both will appear later on the printout. After completing the data entry, please click on *Next*.

Fig. 8 DIALux Light Wizard – Project information

In the window *Data Input* you specify the room geometry on the left hand side. By default DIALux Light produces a rectangular room. If you check the box *Use L-Shaped Room*, DIALux Light shows a L-shaped room. Enter the relevant dimensions with regard to the room figure drawing. You can change on the left hand side the reflectance of the ceiling, walls and floor. The wall reflectance selected applies to all the walls.

Fig. 9 DIALux Light Wizard – Data Input

One click on *Databases* starts a manufacturer PlugIn. In the PlugIn you can select the luminaire which you want to use and then click on *Apply* or *Use*. Then close the PlugIn. Now DIALux Light shows you the selected luminaire on the right above. (By default the last used luminaire is always displayed.) After completing the data entry, please click on *Next*.

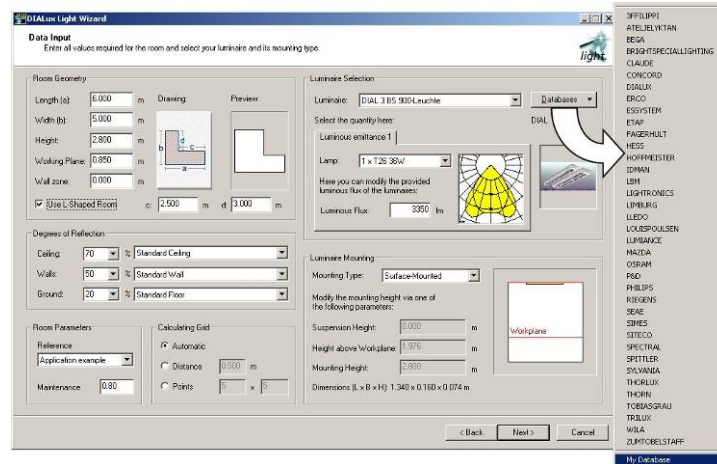

Fig. 10 DIALux Light Wizard – Launch a PlugIn

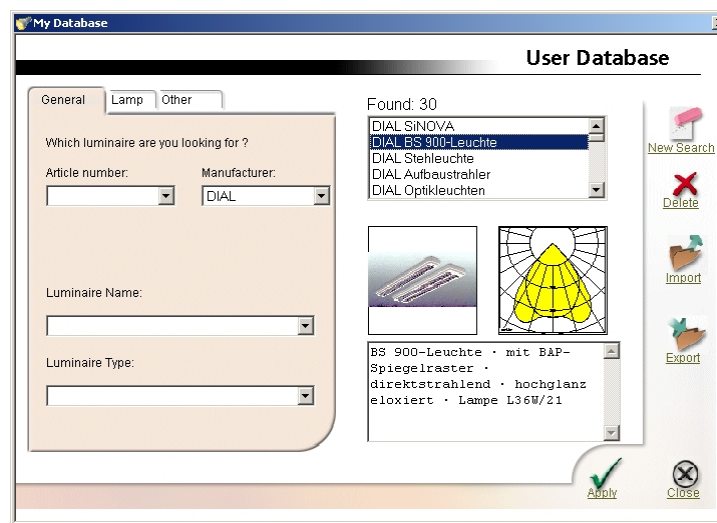

Fig. 11 DIALux Light Wizard – User Database

In the window *Calculation and Results* DIALux Light calculates the number of luminaires by the efficiency method that you need to achieve the desired illuminance. You can enter the desired illuminance in the field *Planned Em*. The luminaires, which are outside the room, are not considered by DIALux Light in the calculation. By using the entry *Horizontal arrangement* or *Vertical arrangement* you can specify the distances of the luminaires to each other and from the wall. After you have inserted all values correctly, click on *Calculate* and DIALux Light will start the calculation.

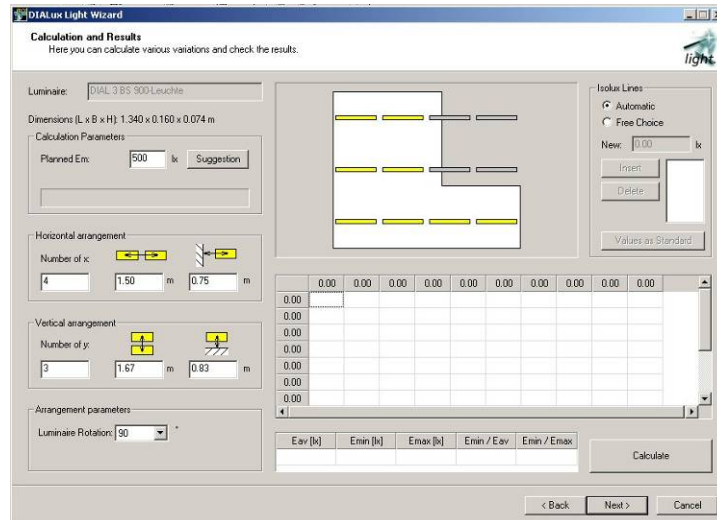

Fig. 12 DIALux Light Wizard – Calculation

Afterwards DIALux Light displays the results in a figure of isolux lines and a table for the work plane.

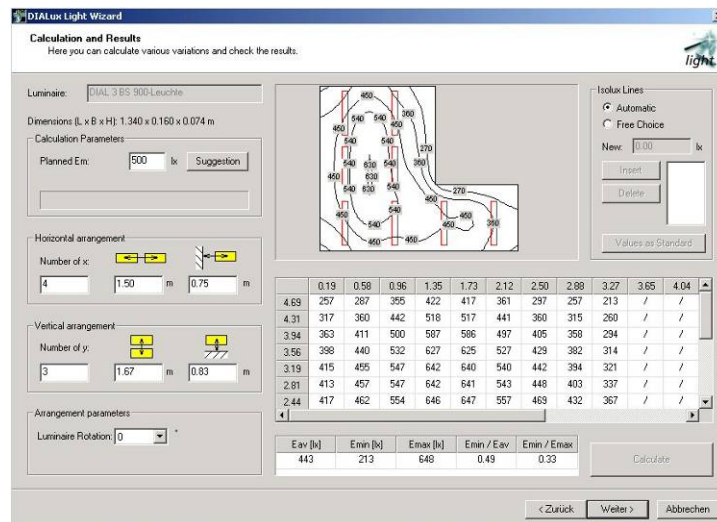

Fig. 13 DIALux Light Wizard – Calculated Result

In the *Result Output* window you have several choices; you can print the results or save them in electronic format as a pdf file. So click the appropriate button. By using the check boxes next to the printout symbols you can affect which outputs are actually printed out. By default all outputs are activated. If you would like to provide for example only a short overview, activate only the summary. If you would like to present the results to your customer, you may wish to activate all outputs.

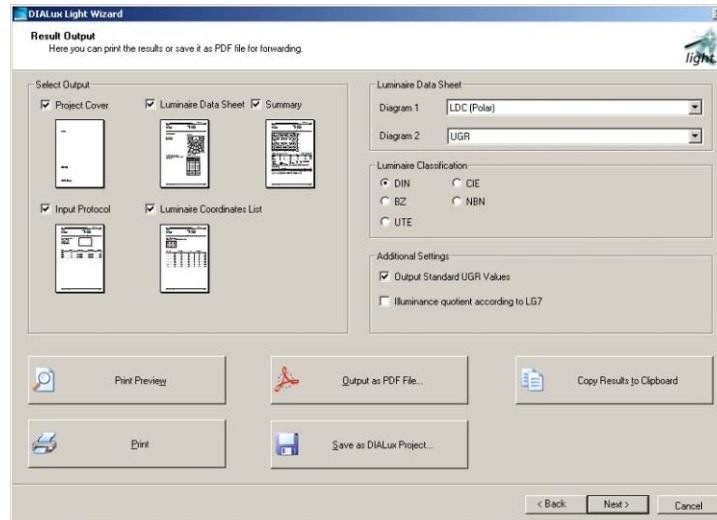

Fig. 14 DIALux Light Wizard – Result Output

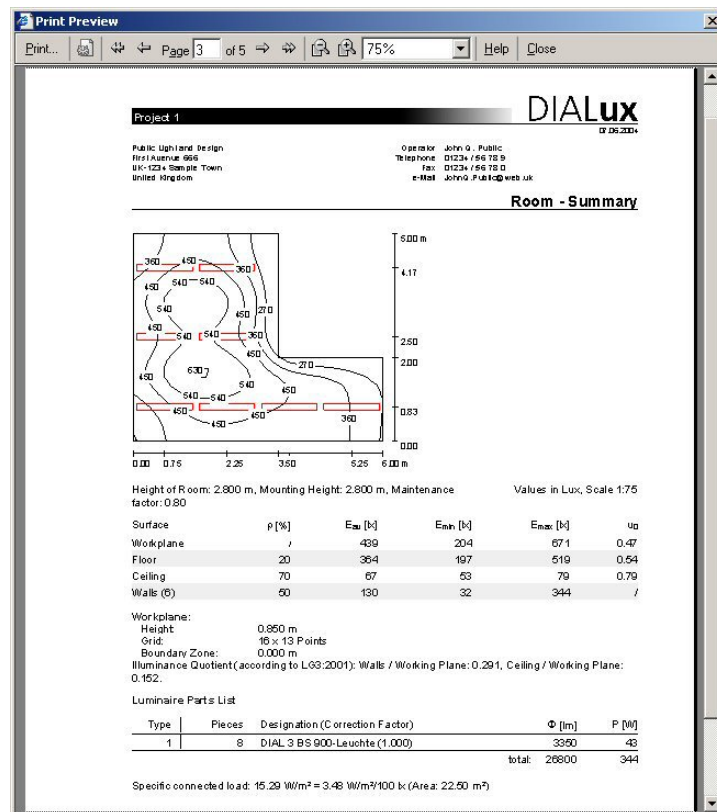

Fig. 15 DIALux Light Wizard – Output

At the end of the DIALux Light Wizard a dialogue is displayed. After you have completed DIALux Light, the calculated result is displayed as 3D rendering in DIALux. Here you have the option to save your calculation results under the menu *File* → *Save*.

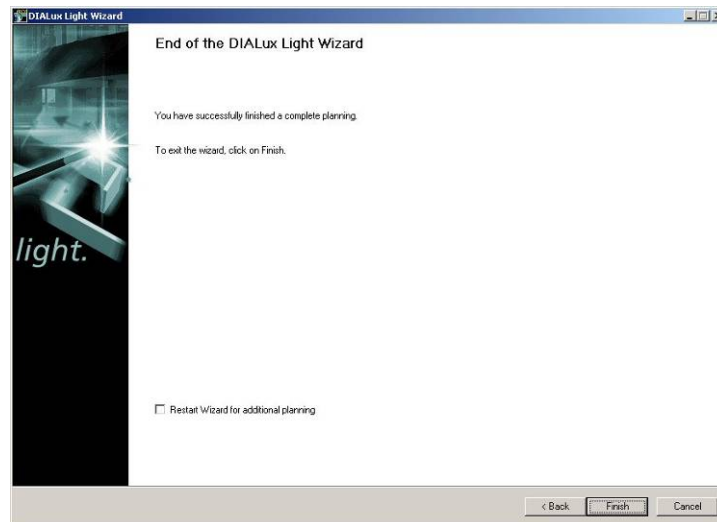

Fig. 16 DIALux Light Wizard – End

Working with Wizards

If you are using DIALux for the first time and you do not have much experience with CAD programs, we recommend that you create your first projects with the help of our wizards.

Experienced users can skip this chapter.

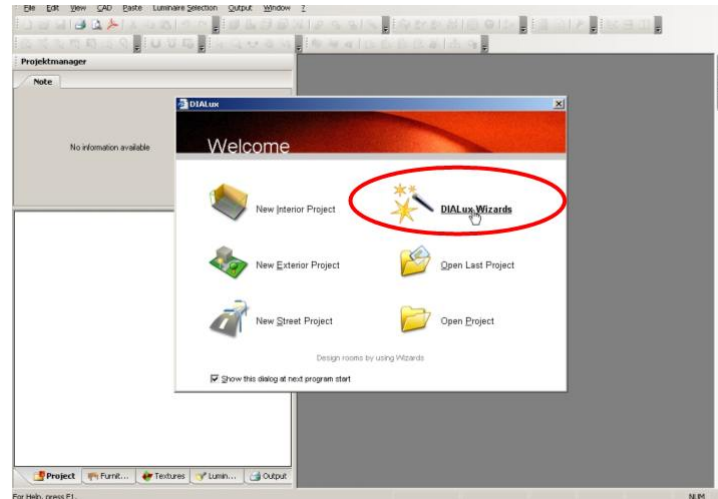

Fig. 17 DIALux Startup Dialogue

After the installation DIALux always starts with a *Welcome* window. In this window you can click with the left mouse button on *DIALux Wizards*. If you do not see this *Welcome* dialogue any more, you will find the wizards in the menu *File* → *Wizards*.

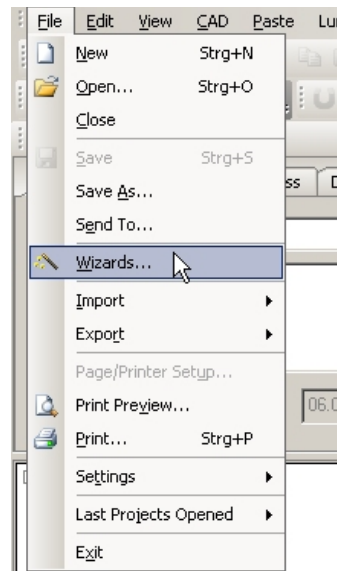

Fig. 18 Launch DIALux Wizard

Fig. 20 Working with Wizards – Room Name, Room Form, Room Alignment

Enter the name of the room, select L-shaped room and afterwards define the orientation.

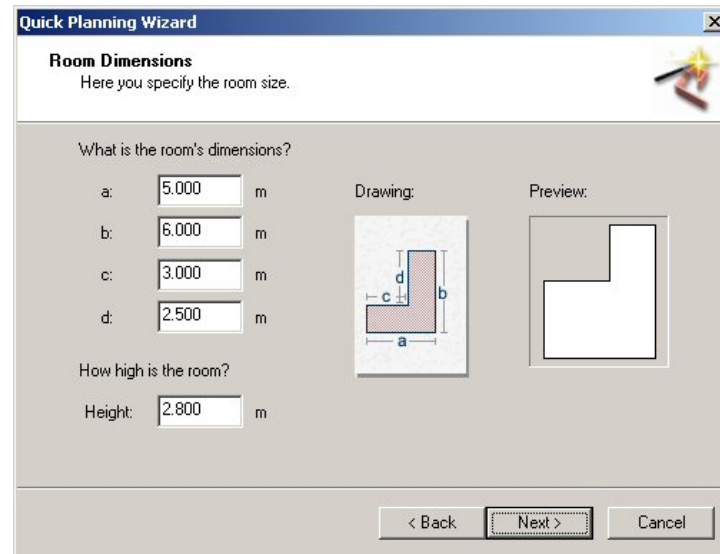

Fig. 21 Working with Wizards – Room Dimensions

Specify the *Room's Dimension* and the *Room Height*. Which wall symbolizes each letter a to d is displayed on the drawing.

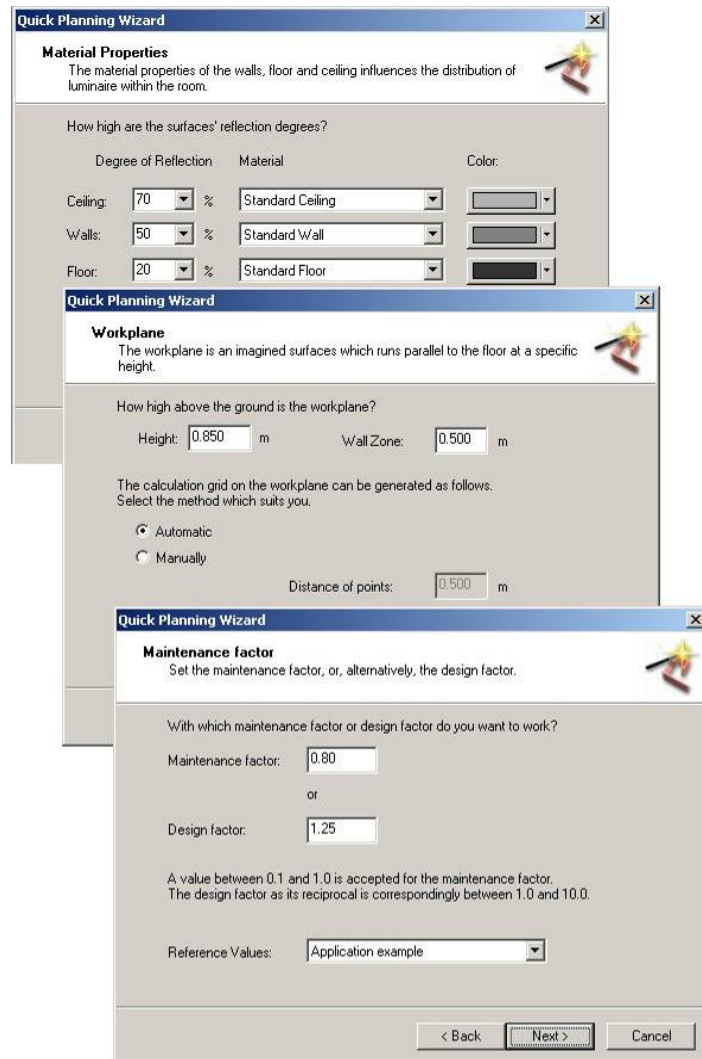

Fig. 22 Working with Wizards – Reflection, Work plane, Maintenance Factor

Specify the *Reflectance*, *Work plane* and the *Maintenance factor*. You can accept also the standard values of DIALux by clicking directly on *Next*.

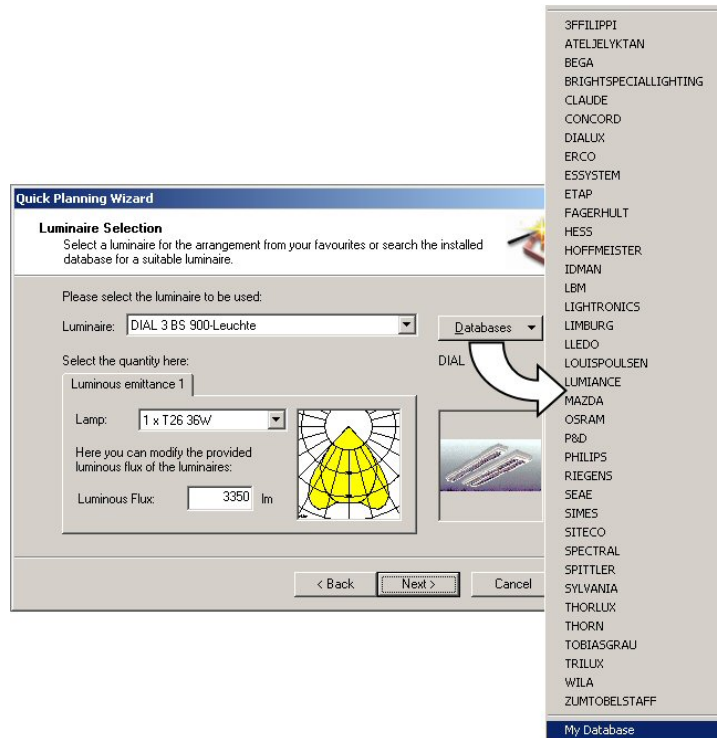

Fig. 23 Working with Wizards – Luminaire Manufacturer Selection

If you click in the dialogue of *Luminaire Selection* on *Databases*, you can launch the installed Plugins or start the *User Database*. Always a few luminaires are arranged in the user database. In the user database you can save your favoured luminaires, in order to have fast access to your frequently used luminaires.

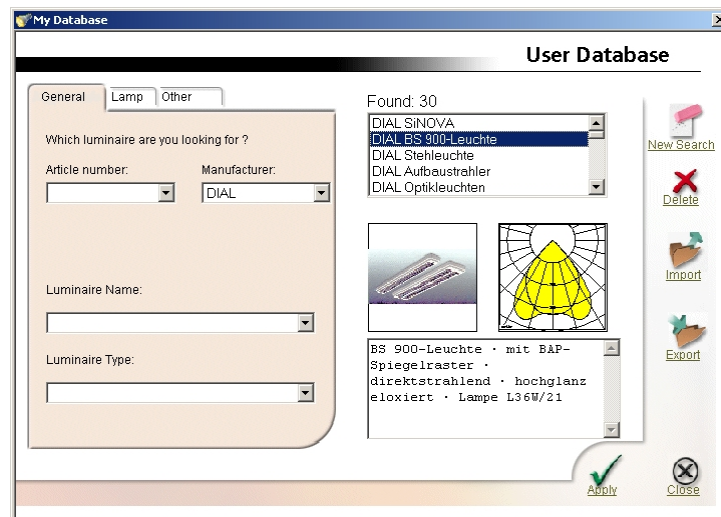

Fig. 24 Working with Wizards – PlugIn / User Database

Select the desired luminaire with the help of the filter functions of a PlugIn or the user database and then click on the button *Apply*. Then please click on the *Close* button.

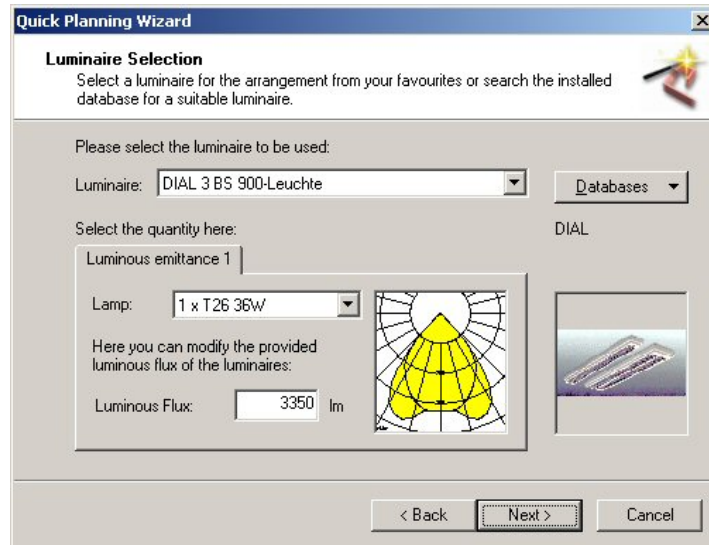

Fig. 25 Working with Wizards – Luminaire Selection

DIALux displays the selected luminaire in the dialogue of *Luminaire Selection*.

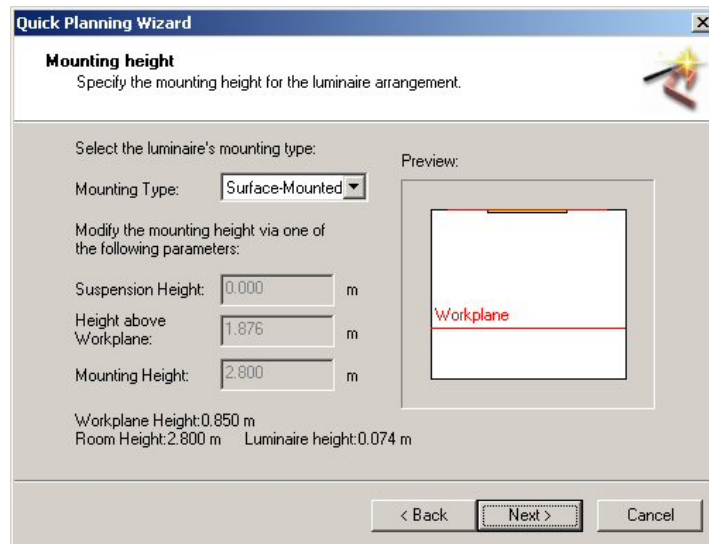

Fig. 26 Working with Wizards – Mounting height

Select the *luminaire's mounting type*.

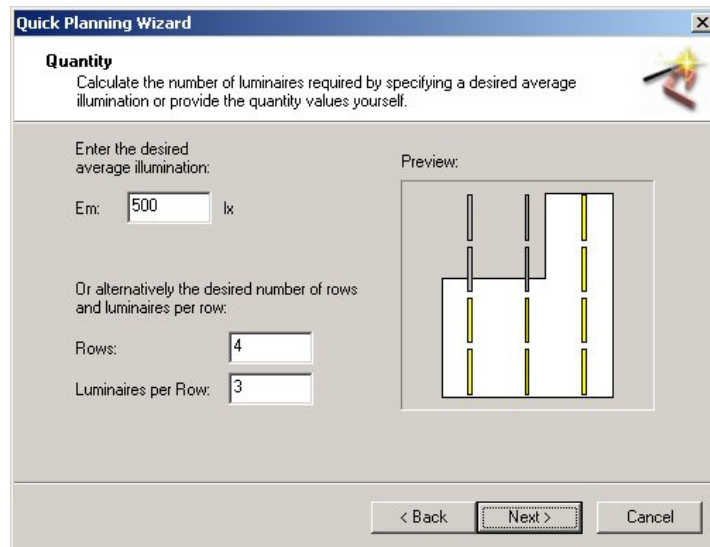

Fig. 27 Working with Wizards – Calculate the number of luminaires

On the basis of the efficiency method DIALux calculates the necessary *number of luminaires* for a specified illumination. The luminaires, which are outside the room, are not considered in the calculation.

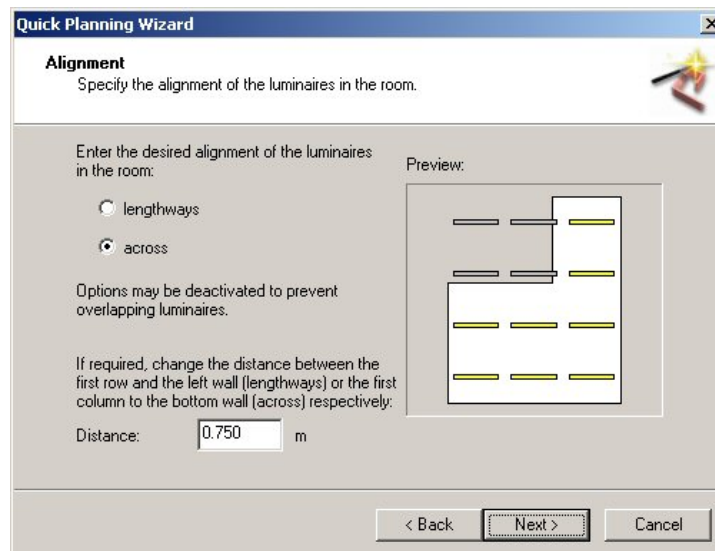

Fig. 28 Working with Wizards – Alignment of the luminaires

In the *Alignment* dialogue you can specify the orientation of the luminaires as lengthways or across.



Fig. 29 Working with Wizards – Calculate result

Click on the *Finish* button and DIALux will begin the calculation and afterwards the calculated result will be displayed.

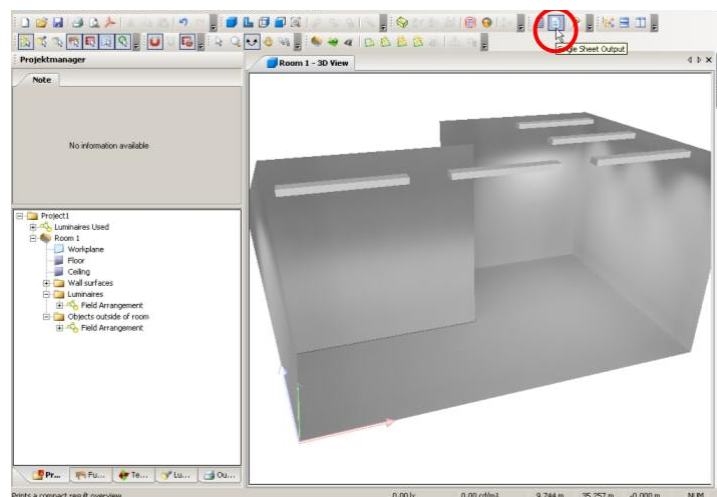

Fig. 30 Working with Wizards – Visually represented result

In order to display the calculated results click in the toolbar on the *Single Sheet Output* button. Afterwards you will see a summary, which displays all the important details on one page.

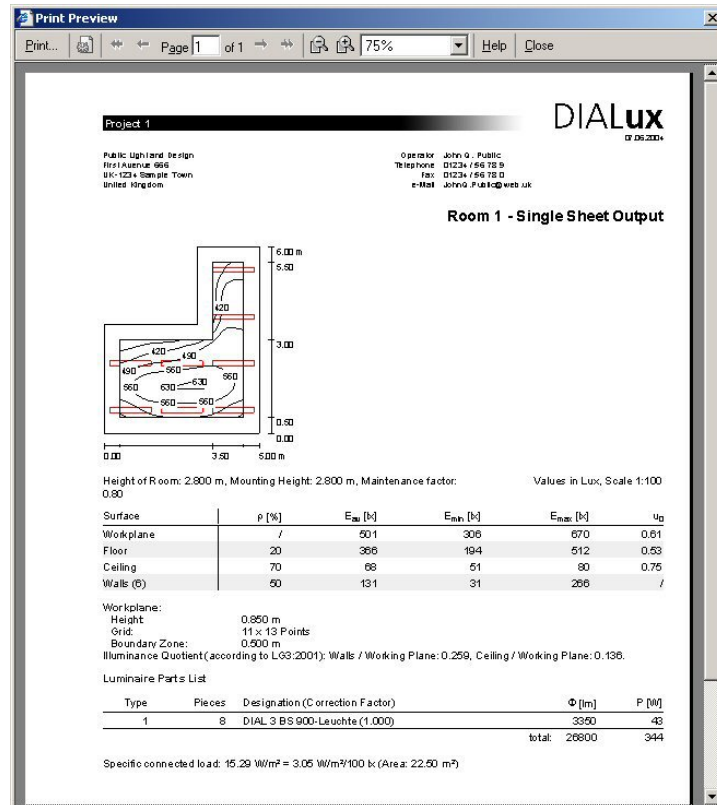

Fig. 31 Working with Wizards – Single Sheet Output

The DIALux User Interface

DIALux has adopted the user interface of Windows XP. Dynamic settings of the toolbar, the new and much more comprehensive *Guide*, simpler dialogues to guide the user all make working much easier and much faster.

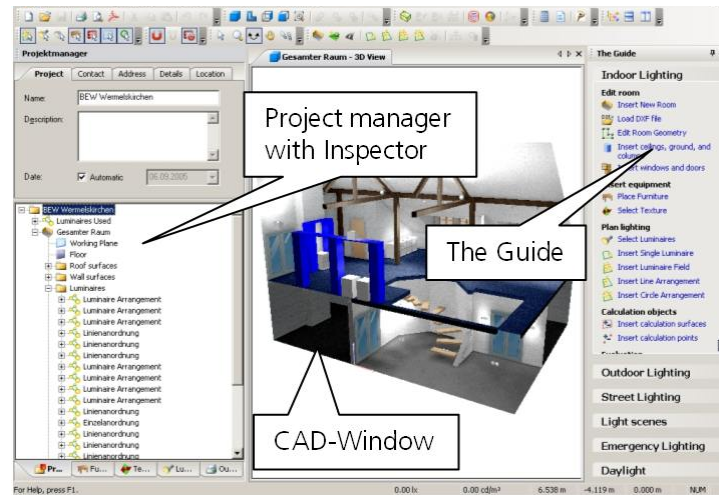

Fig. 32 DIALux user interface

The DIALux *user interface* is divided into three main work areas.

- CAD window
- Project manager with Inspector
- The Guide

These three work areas enable effective and clearly arranged planning of lighting installation with DIALux. In each of these areas you can access certain software functions or edit objects. The *Project manager* includes the *Inspector* and the respective tree structure (project, furniture, colour, luminaire, and output).

The CAD Window

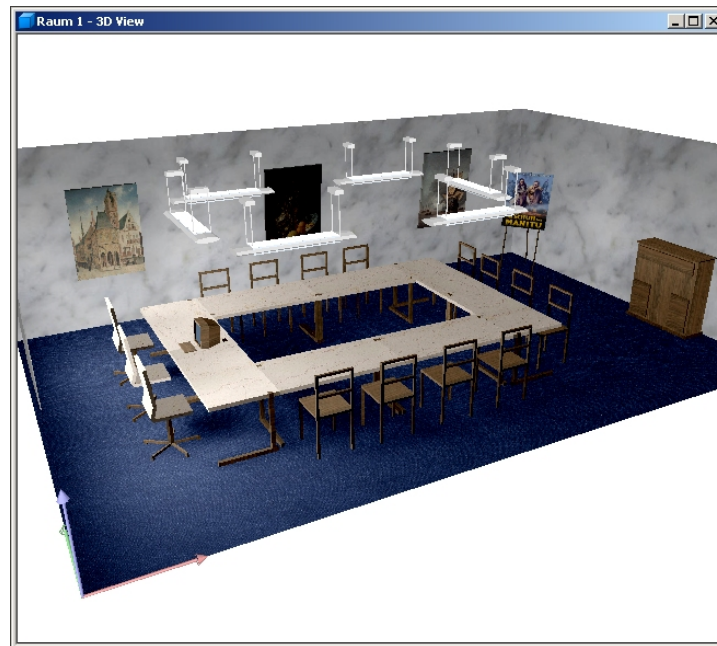

Fig. 33 3D view of a room

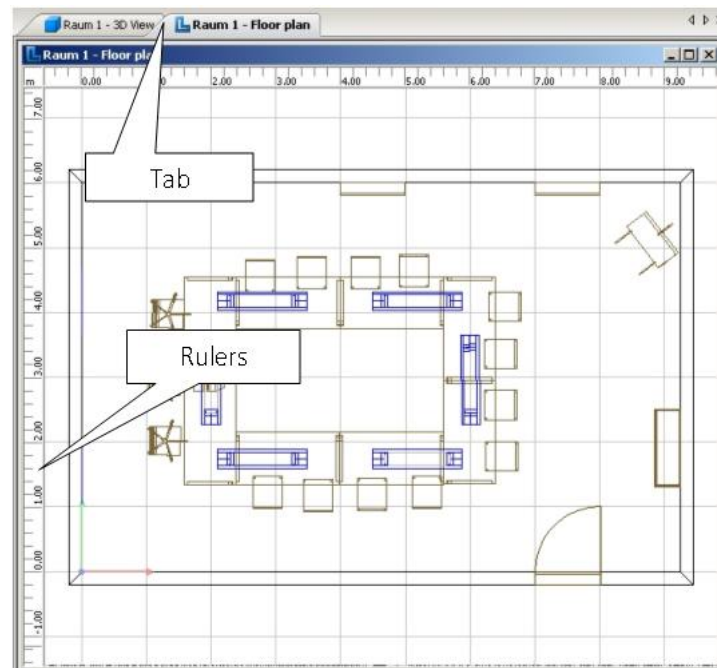

Fig. 34 Ground plan view of a room

In addition to the *3D* and *ground plan* views, you can also use the *side* and *front* view for interactive planning.

The *CAD window* is used for the interactive lighting design. With the mouse, you can graphically *rotate*, *zoom*, *move* and *roam* the room, the street or the exterior scene. The *PAN* or *move* option can always be accessed via the middle mouse button. The *Zoom* option is assigned to the wheel (if using a wheel mouse).

The right mouse button is very important when working with DIALux. Depending on the selected object, the program mode and the working area, different important options can be accessed.



Fig. 35 Right mouse button

Please note:
Open context menu with right mouse button!

Additionally you can move, scale, rotate or select objects inside or outside the room. Right-click to access a context menu.

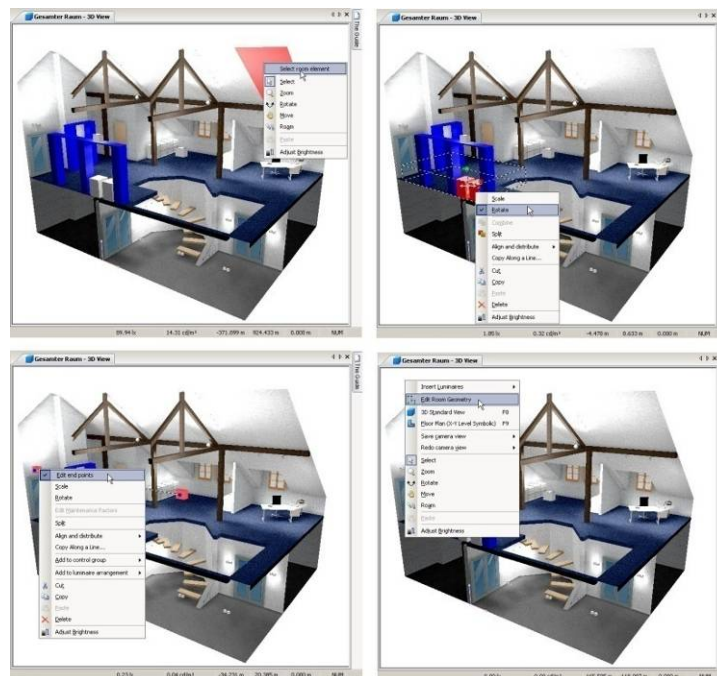

Fig. 36 3D CAD window context menu

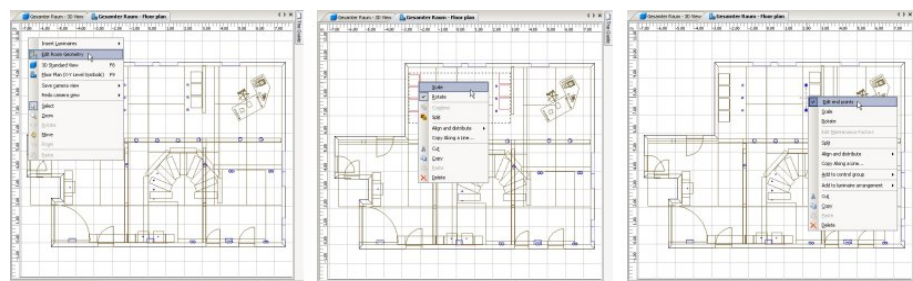

Fig. 37 Ground plan view context menu

In the *project manager* you can right-click inside the room to select the 3D or the ground plan view. If more than one CAD window is open, you can arrange them as desired via the *Window* menu. If the window is full

screen, you can change to another view via the tabs at the top of the screen. Simultaneously working in multiple windows is only recommended when working with a high screen resolution and a good display adapter.

If an object has been inserted into a room, its context menu can also be accessed with a right-click.

Please note:

The **red rotation point** enables a rotation around the **red axis**, likewise the **blue** and the **green** rotation points enable rotations around the **blue** and **green** axis respectively.

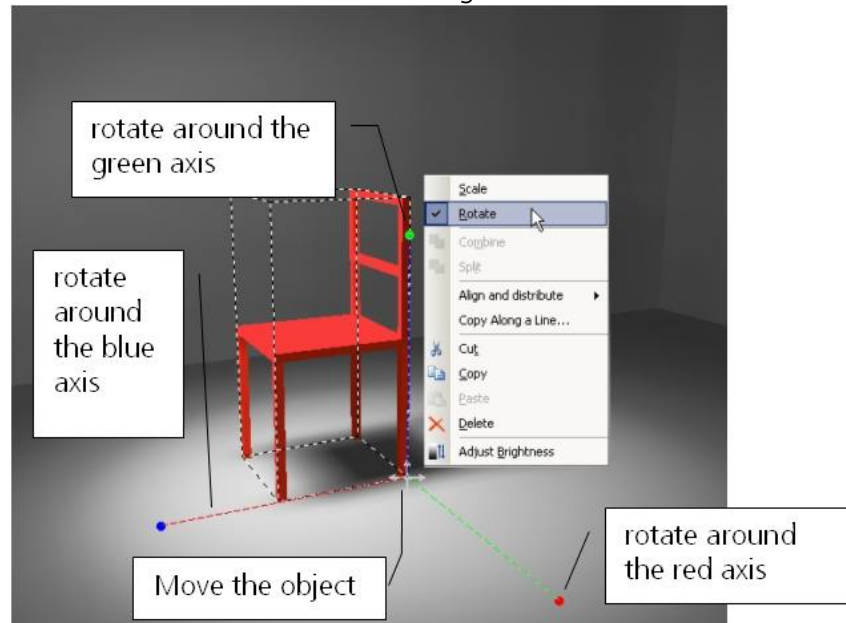
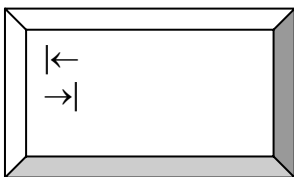

Fig. 38 Context menu of a selected object

If the *Rotate* option is activated, the object can be rotated by clicking and rotating the point on the boom. The red rotation point enables a rotation around the red axis, likewise the blue and the green rotation points enable rotations around the blue and green axis respectively. Please keep in mind that the object has its own coordinate system. The object can be moved by clicking and pulling on the arrow cross.

Please note:

Context menus are accessed via the right mouse button and "Properties" in the Inspector via the left mouse button!



New features since DIALux 4.4:

- now you can switch via the tab key between the rotation mode and the scaling mode
- the object can also be moved at the corners, then even the rotation in 2D will be positioned on adjacent surfaces

The Project manager

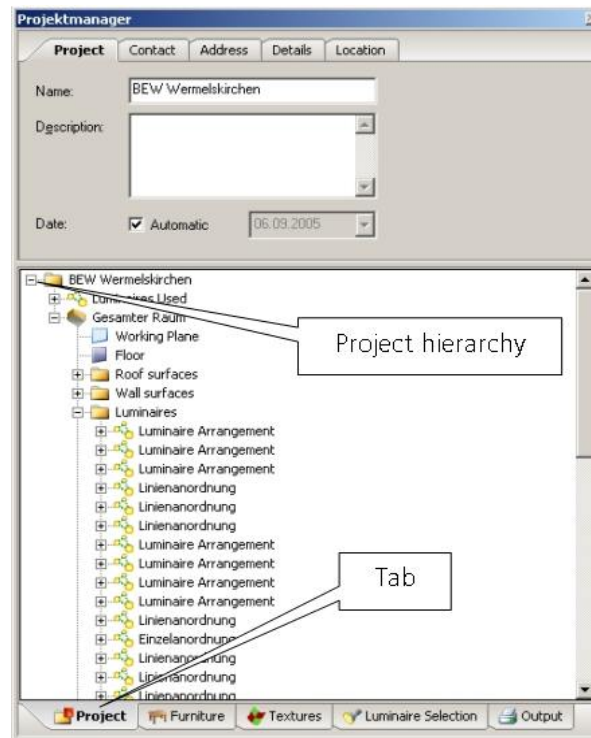

Fig. 39 Project manager

The *Project manager* enables a fast workflow with the elements used in your lighting design. Each individual element can be selected and its properties can be viewed and modified in the *Inspector*. The *Project manager* includes the *Inspector* and the respective tree structure (project, furniture, colour, luminaire selection, and output).

The project, in this example called “BEW Wermelskirchen”, organises the global project information such as the name and address of the operator and the customer, as well as all rooms, exterior scenes, streets and luminaires. In the luminaire list, all luminaires used in this project are listed, which were selected from a PlugIn via *Use*. Here the “alternative” luminaires, which have not (yet) been used in this layout, are also organised.

- The room consists of the following sub-objects: room defining surfaces (floor, ceiling, walls), work plane, furniture and luminaire arrangements.
- An exterior scene consists of the sub-objects: ground element, furniture and luminaire arrangements.
- A street consists the sub-objects: street elements (roadways and lanes, parking lanes, sidewalk, grass strip, bicycle lane and emergency lane) and the luminaire arrangement.

If you select one of these elements (left-click), its properties are displayed in the Inspector. A right-click opens the context menu for that object, just as it does in the CAD view.

The Luminaire Selection

Another tree structure exists for the luminaire selection. This becomes visible if you click on the *Luminaire Selection* tab at the bottom of the *Project manager*.

The screenshot shows the 'Projektmanager' window with the 'Luminaire Selection' tab active. The tree structure is divided into 'My Database', 'DIALux Catalogs', 'Not Installed Catalogs', and 'Online Catalogs'. The 'Online Catalogs' section is expanded, showing various manufacturers like BEGA, ERCO, PHILIPS AEG, etc. Three callout boxes provide instructions: 'Double-click on a Plugin to open it' (pointing to a plugin icon), 'Double-click a not installed Plugin opens the internet homepage of the manufacturer.' (pointing to a manufacturer icon), and 'With a double-click on the online catalogues a luminaire can be selected of the internet homepage of the manufacturer.' (pointing to the 'Online Catalogs' section). Below the callouts, a smaller screenshot shows the 'SMAE' online catalogue interface with a list of luminaire models and their technical specifications.

Fig. 40 Plugin-Tree – Luminaire selection

Installed PlugIns are automatically recognized by DIALux 4.9. It is not required to reinstall the PlugIns after updating from older DIALux versions. Double-click on a PlugIn to open it. You can also access this option via the *Luminaire Selection* menu.

PlugIns provided by our partners that have not yet been installed are located a bit lower in the tree structure. A double-click on a PlugIn which has not been installed opens the Internet Explorer window and the homepage of the luminaire manufacturer is displayed, if available. Some manufacturers provide individual luminaires or entire PlugIns for downloading here.

Create your own luminaire database. Insert, delete, search for specified criteria. Display of luminaire images and technical data.

The User Database

The user has the possibility to select those luminaires from the various manufacturers' PlugIns, which are regular used in the DIALux project. These luminaires can be saved in the *User Database*. It is also possible to search for luminaires and to delete luminaires.

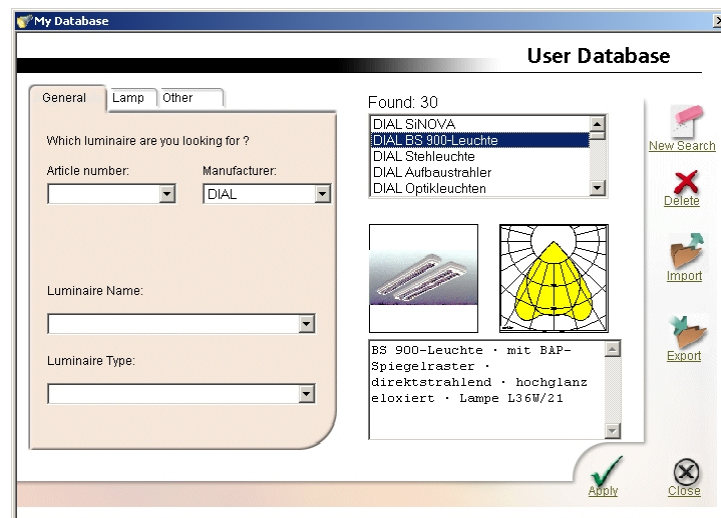

Fig. 41 The User Database

Use the *Import* button to transfer luminaires to the *User Database*. One or several *ULD*, **.ldt* (Eulumdat), **.ies* or **.cib* files can be imported from any desired directory. If a luminaire has been imported into the project – i.e. it appears in the luminaire list – it can be copied to the user database via a right-click.

Insert Luminaire Files into DIALux

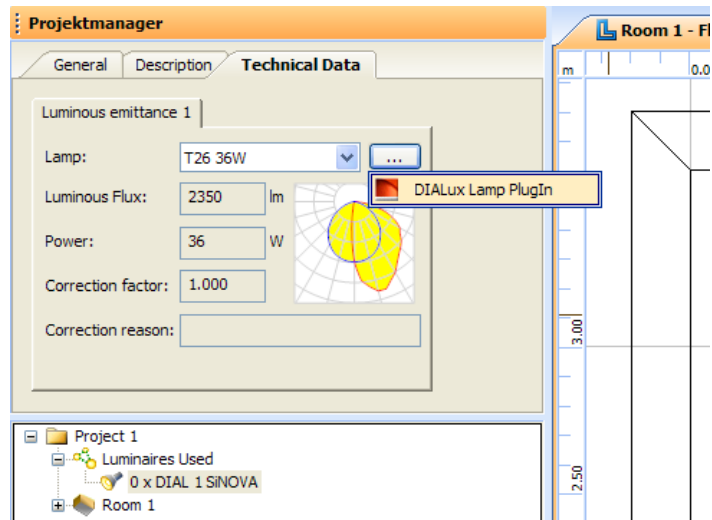

Fig. 43 Starting a lamp PlugIn in DIALux

If there is not yet a lamp PlugIn installed on this computer, you are able to try out the DIALux Lamp PlugIn. If the luminaire manufacturer has entered technical data, it will be used to pre select those lamps that fits into the luminaire. The search criteria can be: ILCOS-L code, power consumption, socket, voltage, etc. The lamp PlugIn then offers those products that fit into the luminaire. You can choose those lamps that are most suitable for the lighting layout. This choice could be a standard lamp or picking from special colours, colour rendering index, long maintenance lamps or other specific properties of the lamp. The lamps include all technical data, even light distribution curves for reflector lamps, so you can decide whether to use a spot or a flood reflector. If the "change" of the light distribution curve is not possible, the luminaire can restrict the replacement of the original LDC.

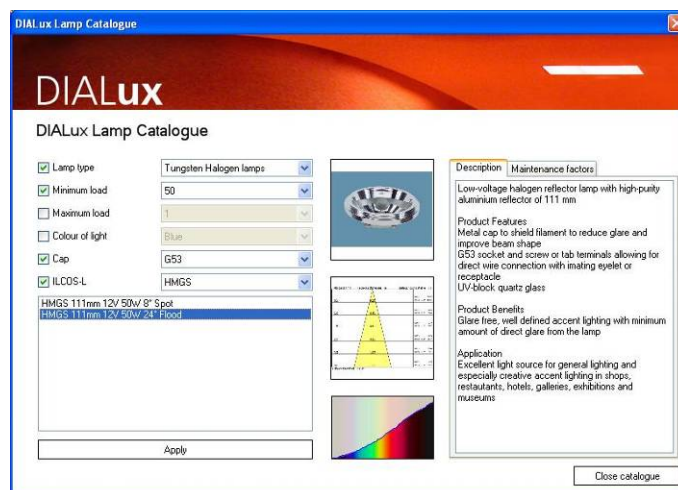

Fig. 44 DIALux lamp demo database

The user can insert one or more lamps to the luminaire. So it is possible to mix up spot and flood reflectors in a line of spotlights or it is possible to mix the light colours

within the some arrangement. The selected lamp can be added to the original equipment or it can replace it.

The Furniture Tree

Furniture can be moved from the *furniture tree* to the project (any view) via the mouse using drag and drop.

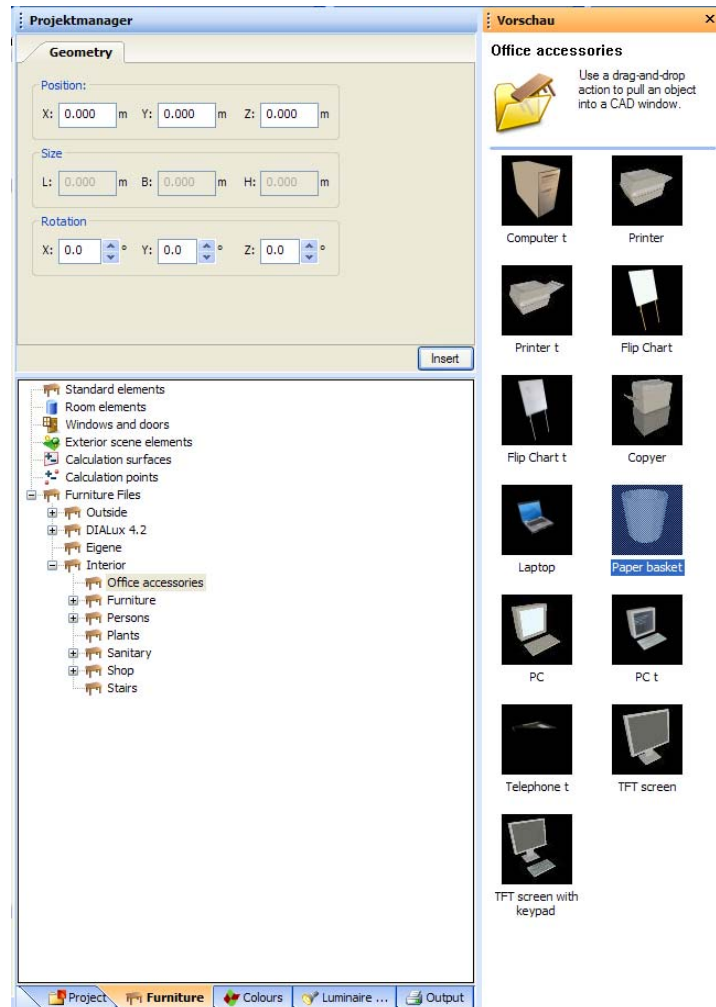

Fig. 45 The Furniture tree

Create your own tree structure. In the furniture tree DIALux shows all directories and *.SAT.files under
 C:\documents and setting\All Users\Application data\DIALux\furniture

The *furniture tree* is divided into seven subdirectories. You can move the preview window of the furniture tree and dock it in various positions in DIALux. You can move and copy furniture from one folder / directory to another. Also you can create new folder and you can delete existing ones. All this is available by a right click on the furniture or on the folder.

Now DIALux saves the furniture as *.m3d files. The benefit is that the preview pictures are saved also in that file. That makes it much easier to share DIALux furniture with friends and colleagues. Of course you can still save them as *.sat and *.jpg files.

The Colours Tree (since version 4.3, formerly Texture Tree)

You can use the *Colours tree* to modify the properties of surfaces via drag and drop - similar to inserting furniture into a room. In the *textures tree* you find predefined textures (surface pictures), RAL colours and you have the option to organise your own textures. You can move and copy textures from one folder / directory to another. Also you can create new folder and you can delete existing ones. All this is available by a right click on the texture or the folder.

The subfolder Light colours and Colour filter will be explained in the chapter Light Colours.

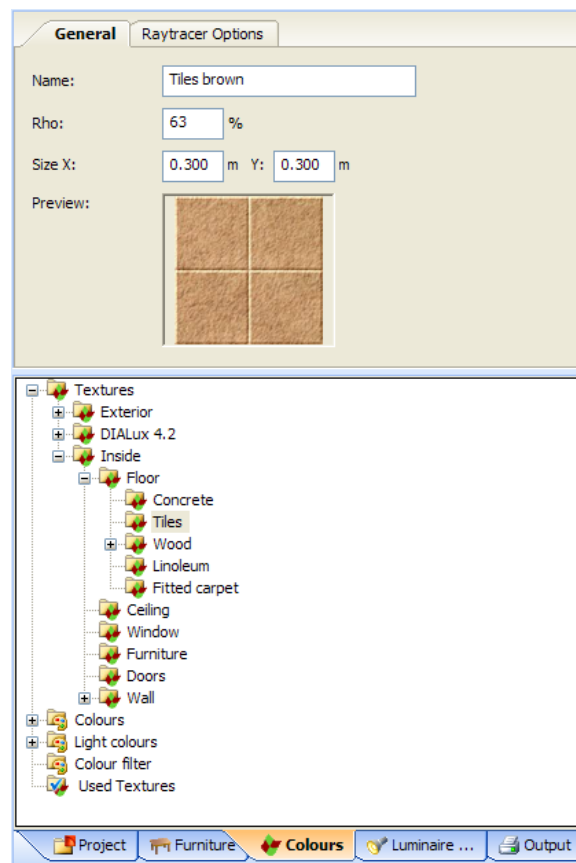

Fig. 46 The Colour tree

When you select a texture in the *texture tree*, the *Inspector* shows a preview of it. After the import the reflection is calculated according to the RGB-values of the texture. You may modify this value later. It is important to specify the real size of the texture. The default value is 1 x 1 m. If you take a photo for example of a building's facade and import this photo as a texture, you have to enter the real size of the building (length and height). After you drag a texture onto a surface, you may modify it (scale, rotate,...). Once a texture is placed on a surface, you can flip /mirror it by entering a negative length (e.g. -0.4m). This will only be used for the selected surface.

The Output Tree

Yet another tree structure exists for the output selection. You can open it by clicking on the *Output* tab in the *Project manager*



Fig. 47 Output Tab

or by selecting the icon in *The Guide*.

Outputs whose page icon is highlighted are immediately available. The output types which are not highlighted can only be obtained after the calculation has been done.

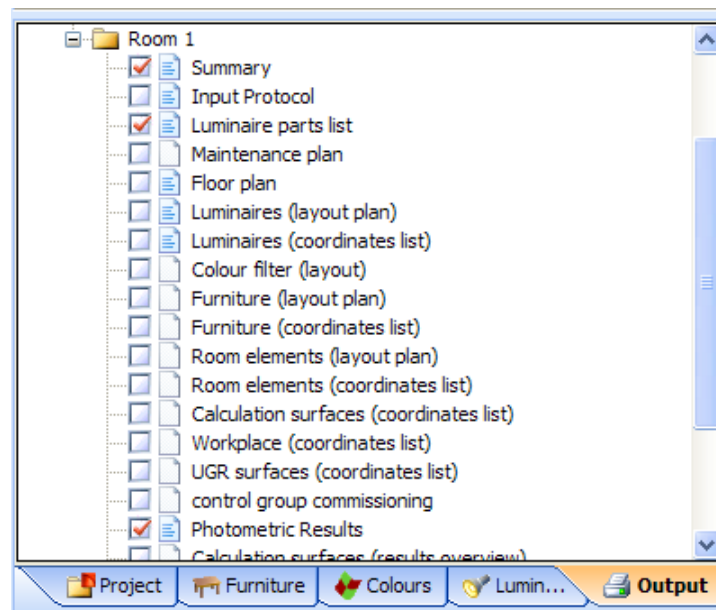

Fig. 48 Output tree

Please note:
The "Output" button in the Guide and the "Output" tab open the output tree

To view an output on the screen, double-click on the corresponding icon. To view multiple output types simultaneously, right-click an output icon and select *Open in New Window*. You can view all types of output on the screen. The output types which have a tick made in the checkbox are printed or displayed as print preview when the *File → Print* or *File → Print Preview* commands are used.

The observer position used in the CAD is used for the output 3D rendering.

You may save the 3D rendering as a *.jpg picture. Just move the rendering into the required position and select in the menu *File → Export → Save CAD view as JPG*. Here you can select a directory and enter a filename.

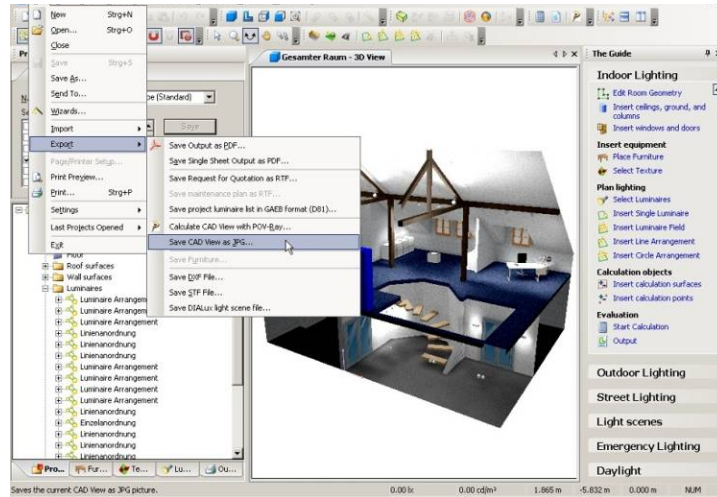

Fig. 49 Save a 3D rendering as *.jpg file

The Guide:
The connecting
element which guides
you through the
programme.

The Guide

The Guide accesses all work steps required for the planning. It provides a “connecting thread” and helps you achieve your aims quickly.

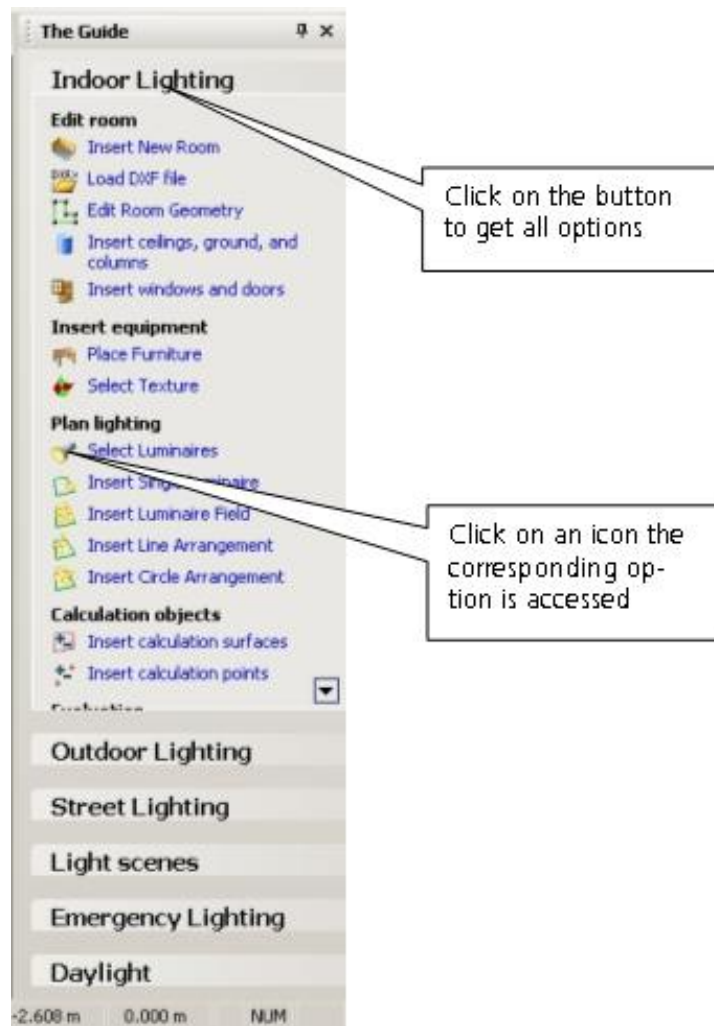

Fig. 50 The Guide

If you click on an icon in *The Guide*, the corresponding option is directly accessed. If you hold the mouse pointer on *Indoor Lighting* all options for planning a room will be available.

You can adapt the guide to your individual wishes. With this function you can hide and unhide respective application fields.

If *The Guide* is hidden you can access it with DIALux 4.9, the function *Display guide window* is in the menu *Window*.

Display Guide window

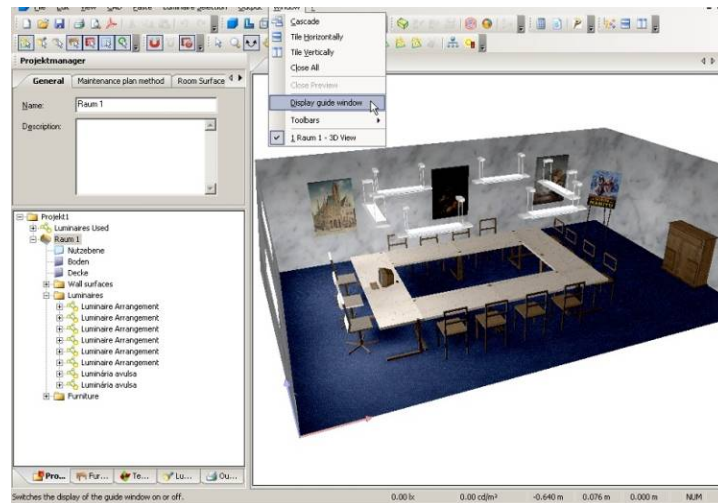

Fig. 51 Display guide window

The Inspector

With the *Inspector* you can view the properties of each object selected either in the CAD view or in the *Project manager*. Here you can also change the properties. Some values have a grey background. These cannot be modified here.

The Inspector
The Inspector displays the Property Pages, which contain the properties of the selected object (here Room 1).

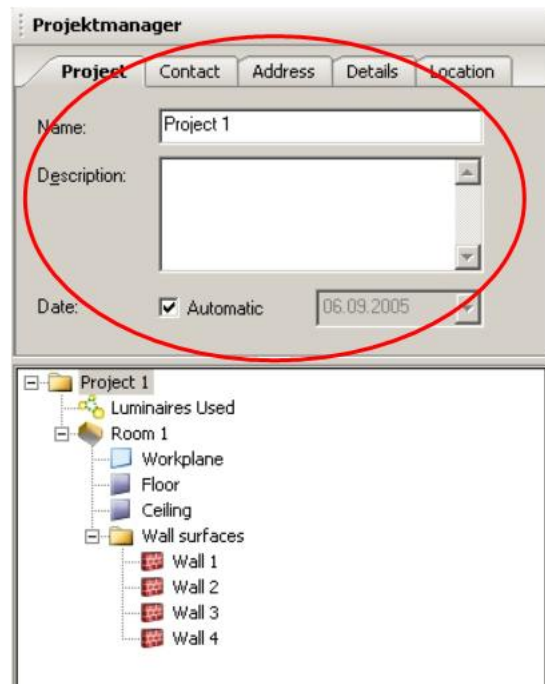

Fig. 52 Property Page of the selected room in the Inspector

Changes to individual walls or to the global setting for the entire room?

Changes to the luminaire or to the luminaire arrangement?

In the previous example you can see several properties of the selected room. Click on the *Room Surfaces* tab to change the *reflectance* properties globally. Beware! Here you can only change the reflectance of all walls together. If you wish to change the reflectance of individual walls, you need to select the corresponding wall and then change its property in the Inspector.

Please keep in mind that the *Inspector* differentiates between individual luminaires and a luminaire arrangement.

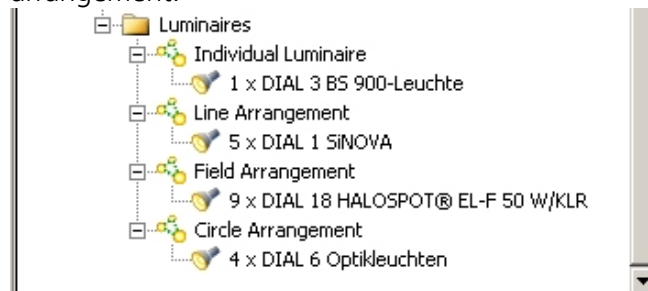

Fig. 53 Luminaire arrangement and its luminaires in the project manager

Here you can change the properties of the entire luminaire arrangement, but not the properties of individual luminaires

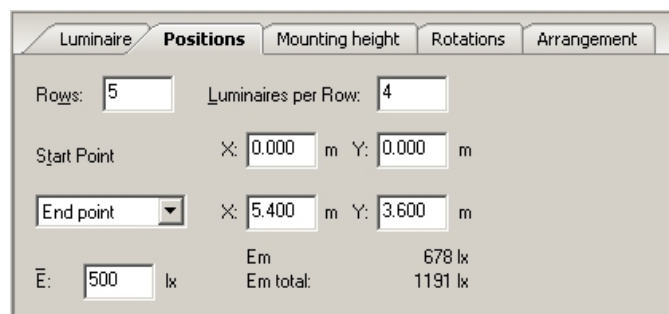

Fig. 54 Property Page "Position" of the selected luminaire arrangement

Here you can change the properties of individual luminaires within the luminaire arrangement, but not the properties of the luminaire arrangement itself.

Property Page colour appearance

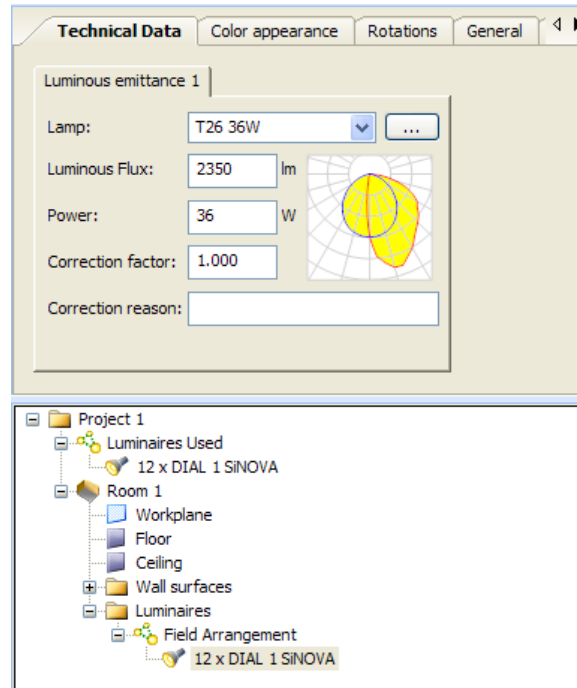

Fig. 55 Property Page of the luminaires within the selection

Edit Mode

When certain options are used, DIALux 4.9 switches to an edit mode. For example, this happens in the following situations:

- Free input of a new room
- Change room dimensions at a later stage
- Edit a ground element in an exterior scene
- Edit a calculation surface
- Edit an extrusion volume

To switch to the edit mode, go to the *Project manager*, select the object you want to edit with the right mouse button, and click on *Edit Room Geometry*, *Edit Ground Element* or *Edit Calculation Surface*. Alternatively you can select the options from the menu *Edit*. A third way is to click on *Edit Room Geometry* in *The Guide*. It is advisable to modify the room geometry in the ground plan view.

Switch DIALux to the "Edit Room Geometry" mode



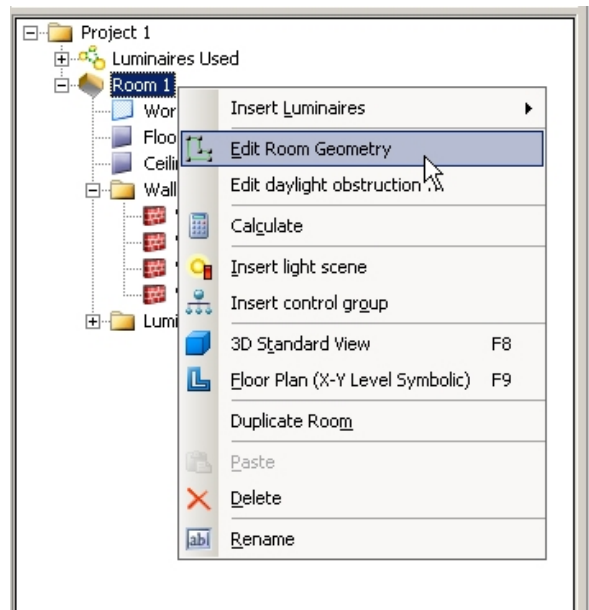

Fig. 56 Room context menu (right-click on room)

After this option has been activated, the room's ground plan can be modified individually. Relevant changes occur to ground elements and calculation surfaces.

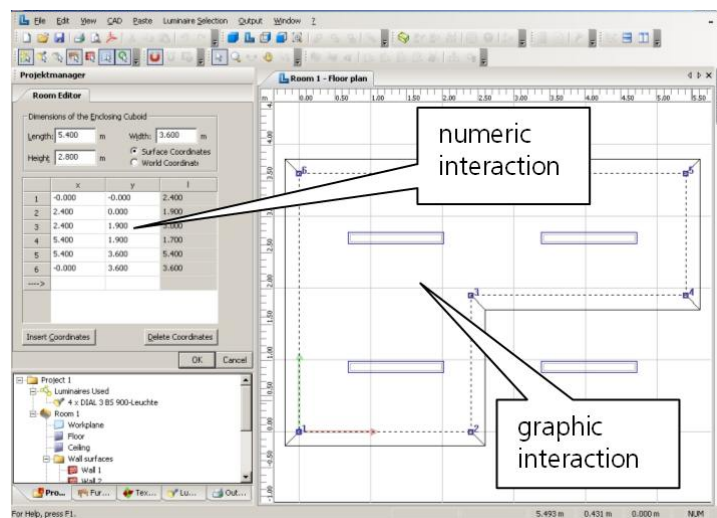

Fig. 57 Room edit mode

Interactive room editing

By clicking on the walls they can be moved interactively within the CAD view, parallel to their previous positions.

Click on the room coordinates to move them to another position in the room as desired.

Right-click on any position on the wall allows you to insert a point at this position via the context menu.

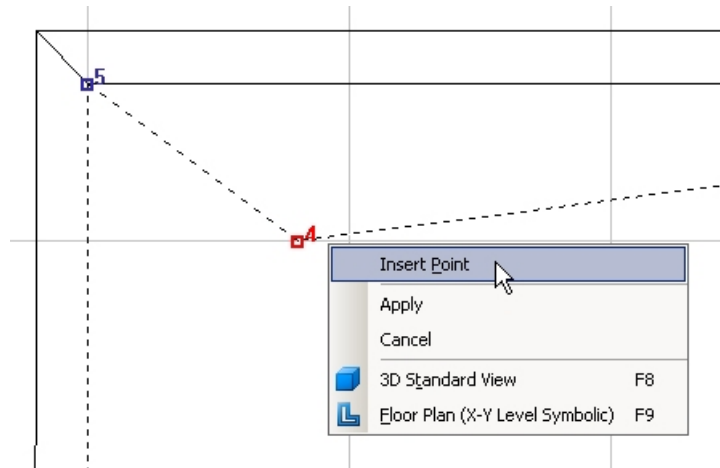

Fig. 58 Insert a new corner

Further room coordinates can be added or deleted in the Property Page by clicking on the corresponding row and selecting *Insert Coordinates* or *Delete Coordinates*. Then you can enter the coordinates numerically. You can also enter the maximum room dimensions via *length* and *width*. All lengths are then correspondingly transformed.

DIALux automatically recognizes whether luminaires are positioned inside or outside the room.

Please note that in the previous example (Fig. 57) the luminaire at the bottom right will not be displayed or calculated after the new coordinates have been applied. If, however, the room is enlarged again, the luminaire is automatically reinserted.

You can edit ground elements of an exterior scene in a similar way. To insert a ground element into the exterior scene use *The Guide* or the *furniture tree*.

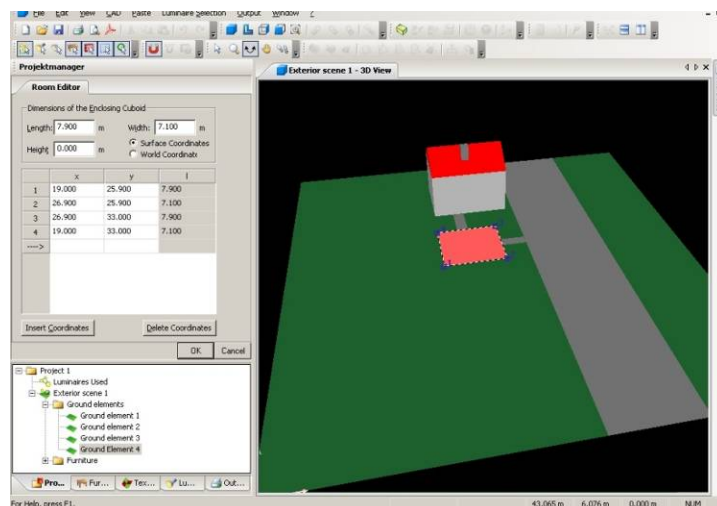

Fig. 59 Edit a ground element

Calculation surfaces and ground elements can have any polygonal shape.

DIALux can handle calculation surfaces with any shapes. You can click with the right mouse button to edit the calculation surface. For example you may create a polygonal task area above a polygonal desk.

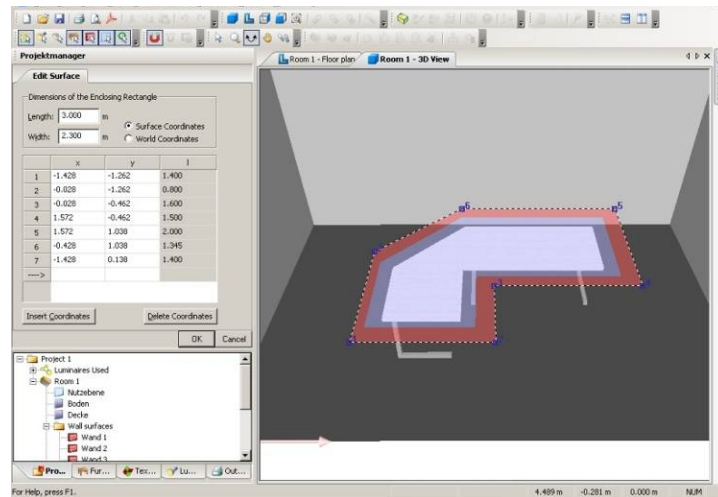

Fig. 60 Create a polygonal "Task Area" above a desk

If there are already help lines placed in the room or exterior scene, their shape can be used for the surface which is currently in the edit mode. This is very helpful if firstly the shape of a template (DXF/DWG) has been copied with a helpline and secondly this shape should be taken over for the surface (room, ground element, calculation surface or extrusion volume). This function is started when making a right click on a helpline while the surface is in edit mode.

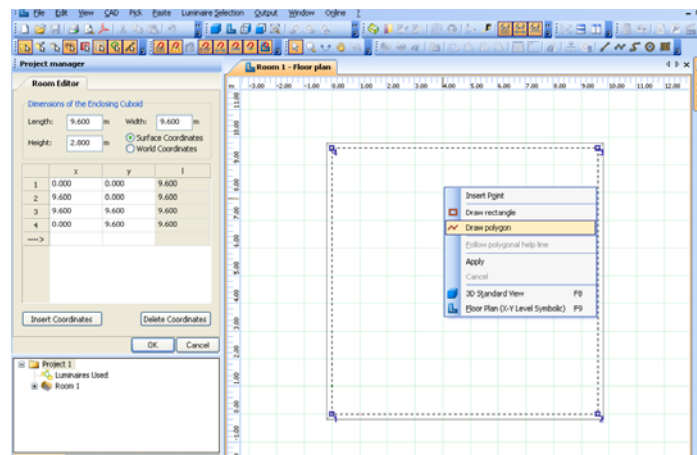

Fig. 61 Taking over the shape of a helpline for the room geometry

Optimise Personal Settings

The presetting that DIALux has can be changed. You can find all the menus for modification under *File* → *Settings*.

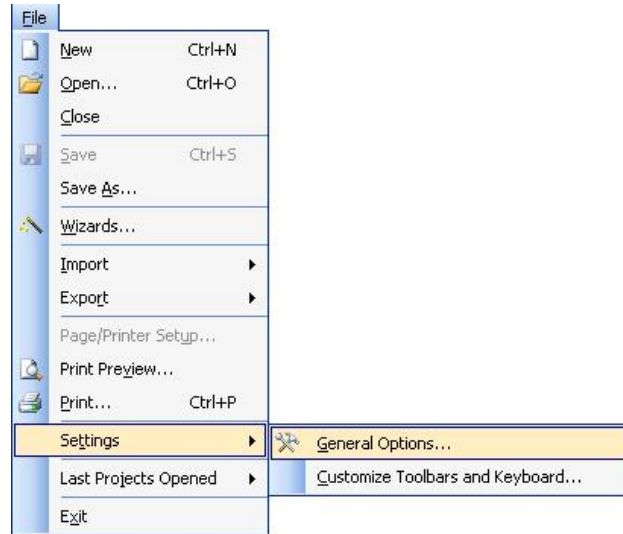

Fig. 62 Menu Settings

General Options

The menu *General Options* has 8 tabs with various settings. Under *Standard Values* you can specify the national typical settings *Room Dimensions*, *Reflectance*, *Work Plane* etc.. Here you can determine which standard values DIALux should use. When creating new rooms, these values are used as presets. Of course you can change the current planning values or standard presets at any time. That means if you want to accomplish calculations for another country you do not have to change each entry individually. DIALux has the relevant parameters for all the usual standards and regulations of individual countries.

Furthermore you can activate the British standard *LG7* and the Australian standard *IEQ-7*. You can see those standards in the output under *Summary* and *photometric results*.

Hint: These changes do not change the DIALux language setting.

As an alternative you can change the values individually.

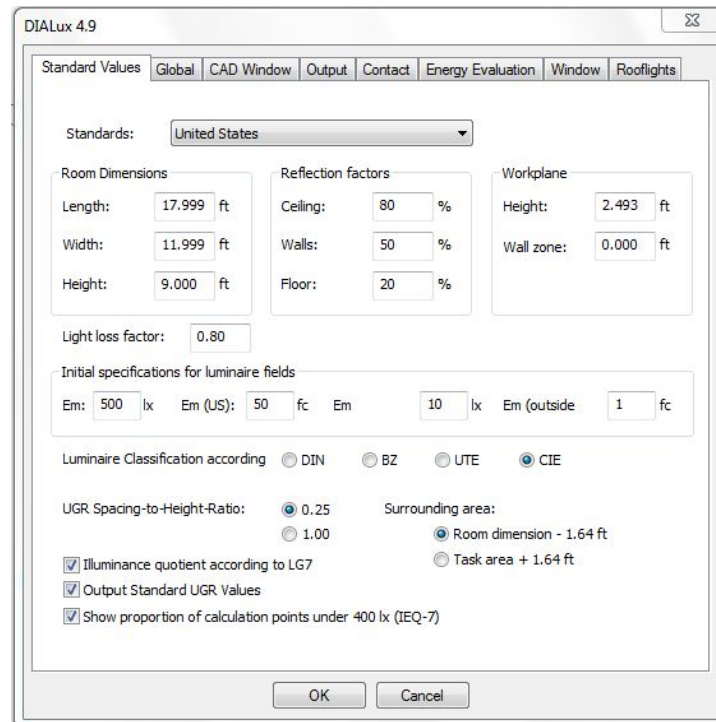

Fig. 63 General Options – Standard Values

If the *Global* tab is selected, you can define the directory (the folder), in which you will save the projects.

By using the entry *Language* you will change the language of the DIALux user interface. By default DIALux always starts with the language of the computer operating system.

If a different language is selected DIALux will need to be closed and restarted to activate the language change.

Under the *Global* tab you can specify additionally the dimensional units (metric or imperial) and the photometric units (European or American).

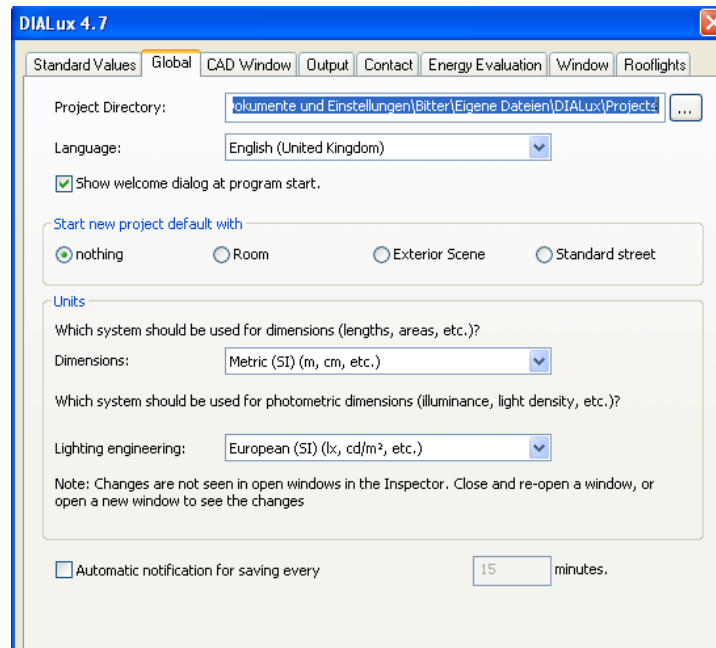

Fig. 64 General Options – Global

A convenient and practical functionality is the automatic reminder to save data. You can set the time intervals individually. During work on a project, when the set time has expired, an info reminder box appears automatically. This allows you to carry out an initial saving of the project or, if you have already stored the project, to re-save it.

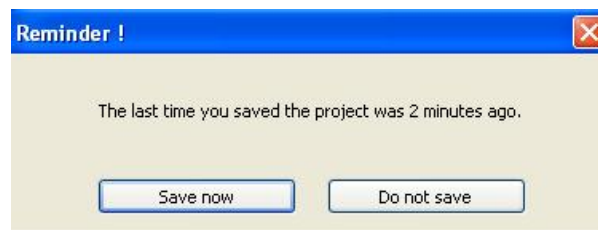

Fig. 65 Automatic reminder to save data

If the *CAD Window* tab is selected, you can select the *Background Colours* for your project and for the printout.

Direct3D as an alternative to OpenGL

DIALux uses the most modern techniques for visualisation of the lighting design. Before OpenGL or the MESA mode was used. Because several graphic card drivers, especially those from the “chip on board” cards, don’t have good support of OpenGL, DIALux is now also able to use Direct3D for the visualisation. Several graphic card drivers offer a better support for Direct3D than for OpenGL. We recommend working in OpenGL mode. If some problems in the visualisation or even crashes occur, you should switch over to Direct3D mode. If your

graphics card doesn't support this mode you will have to work in the MESA mode. This is the slowest mode but it is also the most reliable. The graphic mode can be selected from the Windows All Programs menu by selecting Start Options for DIALux or you can define the standard mode for your PC in file -> settings -> general options -> CAD window.

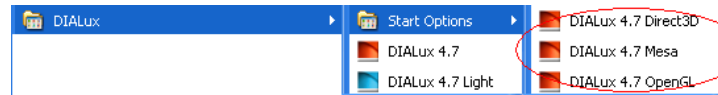

Fig. 66 Start options

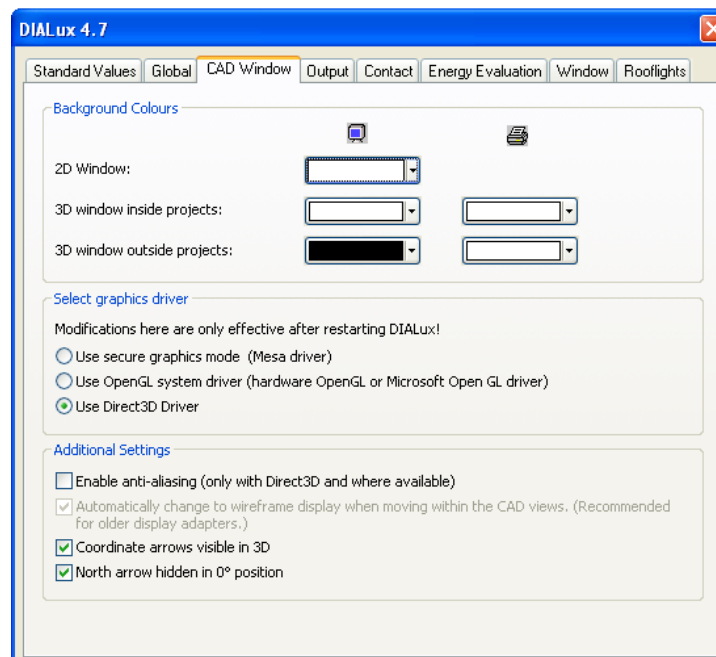

Fig. 67 Graphic mode

If you have an "older PC" it is advisable to select the *Automatically change to wireframe display when moving within the CAD views* option. If you move within the CAD while this option is activated, the room display is updated smoothly, following the mouse movement. After the mouse button is released, the entire scene is displayed again. Thus the calculation time is reduced and you can work with DIALux without disturbing "jerking" on the screen.

Hint: By default the upper setting is activated. If you have an "efficient" PC, it is worthwhile trying the deactivated function. We suggest you use OpenGL mode if possible.

If you want the X, Y and Z coordinate arrows to be visible in the 3D view, switch the *Coordinate arrows visible in 3D* option on. Since DIALux 4.1 you can hide the north arrow in 0° position.

In the Output tab you can adjust general settings for your output that appears on the relevant pages. You can specify font sizes and line thickness of the outputs in the *Output* tab.

Here you can modify the output *footer* and the *logo*. For the logo please click on the three-point-button besides the field *Logo* and then select the file in the opening window, which contains your logo. DIALux opens bitmaps (BMP) or JPG's.

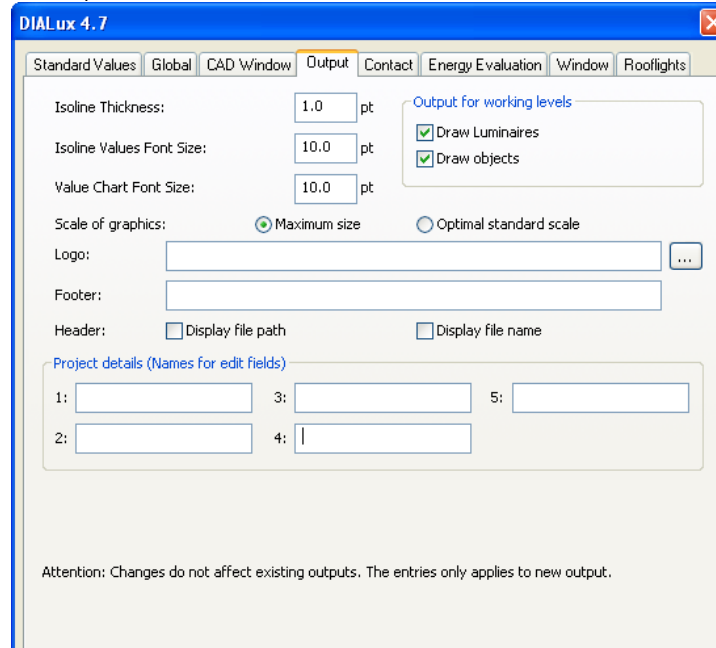

Fig. 68 General Options – Output

In the last tab *Contact* you can register your name and address. Here the address of the company doing the layout planning is entered. It appears in the output header. These entries are used in the Property Page of the project. Information about the operator is entered here too. This is then transferred in each new project.

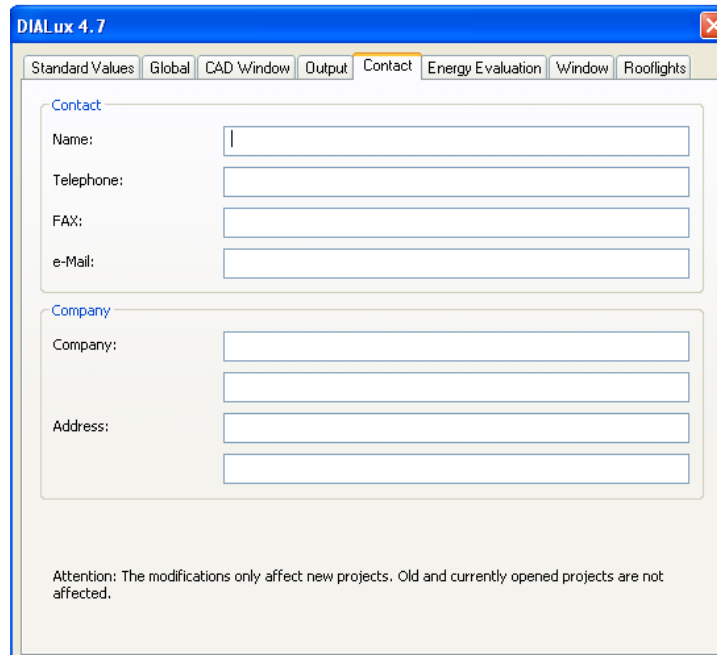

Fig. 69 General Options – Contact

If the *Customise* function is selected, which you can access via menu *File* → *Settings* → *Customize Toolbars and Keyboard*, you can select the toolbars, which you need most frequently. As soon as you launch this function, you can alter the existing *Toolbars*. With the left mouse button you can drag the functions, which you do not need, into the *Command* tab. You can extract the functions, which you need, from the tab to the desired position. DIALux supports the standard Window's *Shortcuts*, which you can launch by combinations of shortcut keys. You can specify additional combinations in the tab *Shortcut Keys*. The tab *Options* provides the option to select more settings in the menu.

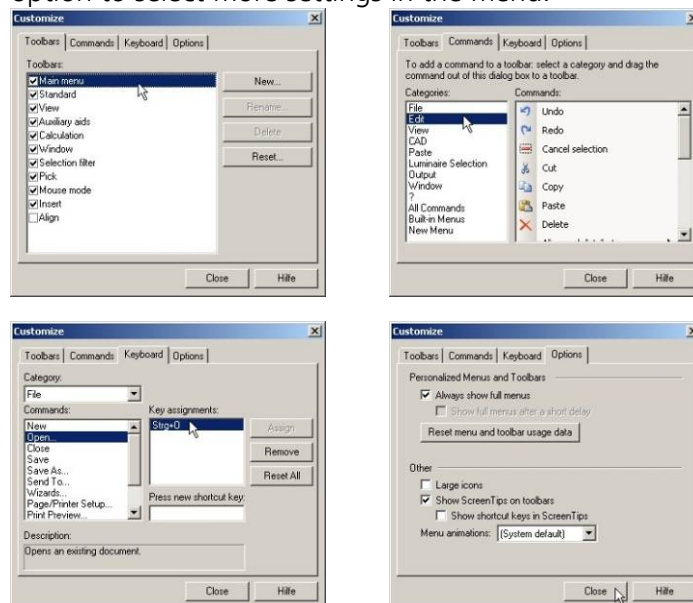

Fig. 70 Menu Customise

Menu "?":
Reset user interface

You can reset the user interface of DIALux in the menu ? to restore the default setting at the next start of DIALux.

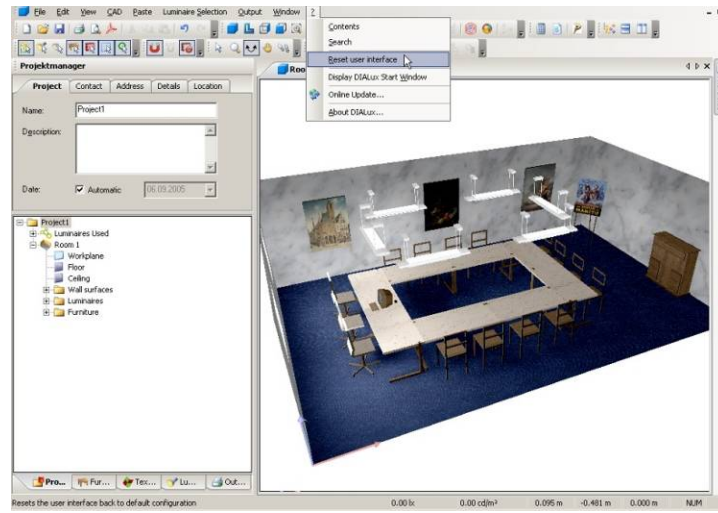

Fig. 71 Reset user interface

Create a New Project

If you click on the *New* button you will generate a new project. DIALux can handle only one project at a time. An already opened project must therefore be closed before the new project can be generated. In the *Inspector* you can define the *Project Name* and *Descriptions* of the project. DIALux adds automatically the creation date. Alternatively you can edit the date, by deactivating the *Automatic* box.

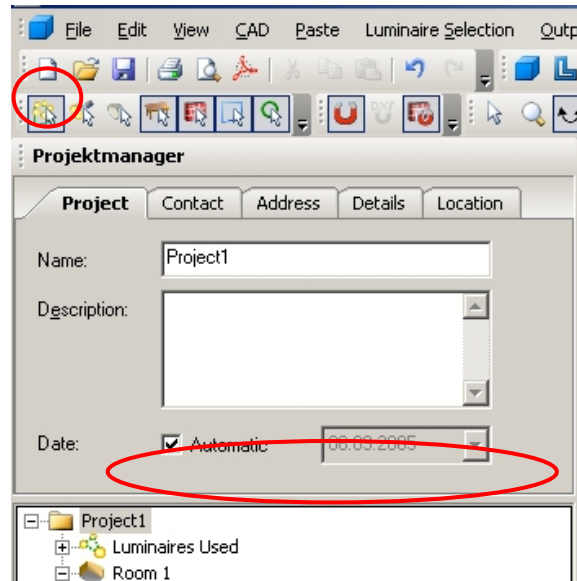

Fig. 72 Create a new project

On the second tab you can arrange your *Contact* data. These are replicated from the option settings, if necessary you can modify these here. In the third tab your *Address* is located and in the fourth tab are the *Details* of the project. These details will appear also on the title page of the output.



Fig. 73 Insert project details

Since DIALux 4 the additional tab *Location* is included. This tab provides for the determination of the position of the sun with the daylight calculation (see chapter Daylight calculation in DIALux). You can insert here the location, provided that this is not selectable from the available list, as well as the longitude and latitude in degrees, time zone and summer time. Deactivated checkbox summertime is equal to the wintertime. You can save your inputs and remove any.



Fig. 74 Insert Project data – Location

Input data of location for the daylight calculation

Open a new project

An already existing project can be reopened at DIALux start, if you click in the start window on *Open project*

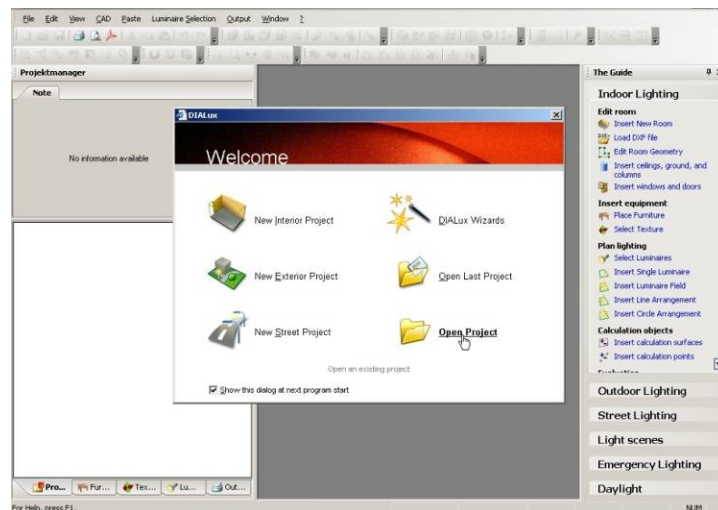

Fig. 75 Open a project in the startup dialogue

or in the menu *File* → *Open* you can access the saved project by double-click on it.

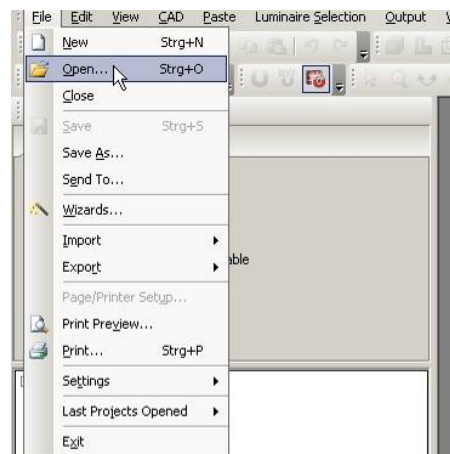

Fig. 76 Open a project in the menu

Project information in the file open dialog

The file open dialog has changed in the latest version of DIALux. While opening an existing project the user can see the most important information about the file.

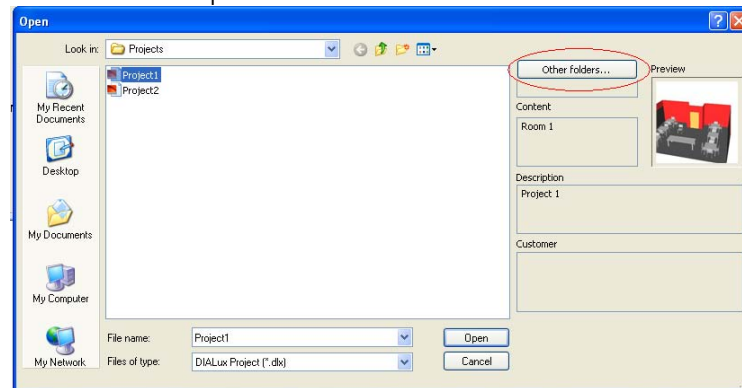

Fig. 77 Project preview

The information given in this dialogue about the project is the 3D view of the first room or exterior scene, information about the designer, the description and the name of the customer. The button "other folders" opens a list of directories formerly used to store DIALux projects in.

Edit Rooms

In order to generate a room, click in *The Guide* on the *Insert New Room* button.



Fig. 78 Edit Rooms – Generate a new room

Edit Room Geometry

Afterwards the ground plan view appears on the right side within the CAD window and the room coordinates are displayed in the *Inspector*. Generally the coordinate origin of the room is down left ($x=0, y=0$). You can change the room geometry by moving the individual points via the mouse or you can insert points with the right mouse button. Alternatively you can edit the room coordinates in the *Inspector*.

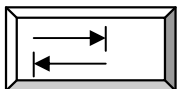

DIALux transfers the values entered in the table after you have operated the tab key. After finishing editing the room data confirm with the *OK* button.

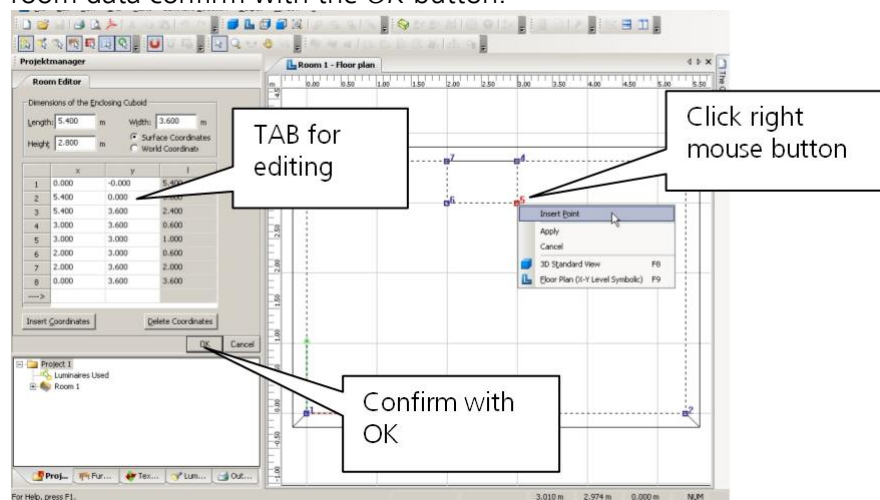

Fig. 79 Edit Rooms – Insert room coordinates

Instead of making a manual entry, you also have the option to draw the room geometry with the aid of a rectangle or a polygon.

If you do not see all of your room, you can zoom out from the view by using the (Overall View of the Scene) *loupe* button for the complete room view.



Fig. 80 Edit Rooms – Zoom to the overall view of the scene

In order to see the 3D view you can use the right mouse button or click on the cube symbol (3D standard view). You can use the double arrow for the rotation of the 3D view. The button operations are: the *loupe* zooms, the *hand* moves and with the *two feet* you can roam the scene. If you use a wheel mouse (see page 35), these functions are also available.

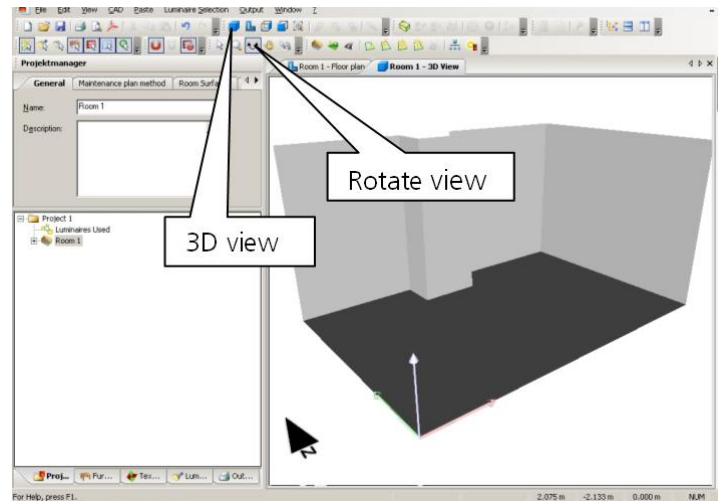

Fig. 81 Edit Rooms – 3D view

Edit Room Data

If you select a room in the *Project manager*, you can specify different properties via the *Inspector*. In the *General* tab you can define the room's *Name* and a *Description* text.

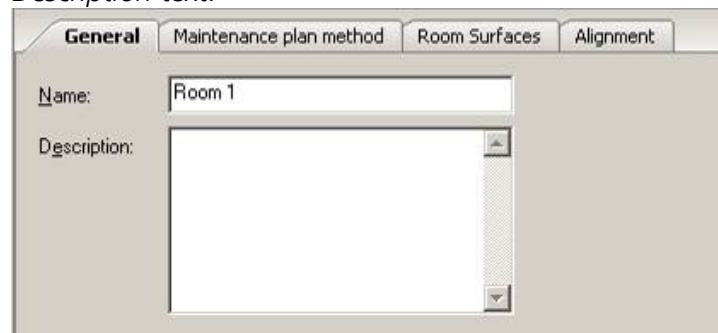

Fig. 82 Edit room data – General

New in DIALux 4 is the maintenance plan method tab. Here you can determine maintenance factors and set parameters for a maintenance plan, based on EN 12464-1 and CIE 97. The maintenance parameters of the inserted luminaire arrangements can be optimized to a target maintenance factor. It is possible for the user to use the maintenance factor as a consistent value for all luminaires in the room. The lighting designer is required, since the introduction of EN12464, to provide a maintenance plan for the lighting design. Now with DIALux 4 this is integrated into the lighting design workflow and is automatically provided.

The screenshot shows the 'Maintenance plan method' dialog box with the following settings:

- General** tab selected.
- Maintenance plan method** title.
- All inclusive** radio button is selected.
- Maintenance factor:** 0.80
- Reference:** Please select an application e (dropdown menu)
- Extended (EN 12464)** radio button is unselected.
- Ambient conditions:** Normal (dropdown menu)
- Maintenance:** Annually (dropdown menu)

Fig. 83 Edit room data – Maintenance plan method

Maintenance plan method for determination of the maintenance factor

An easy method for determining maintenance factor

In DIALux the user is able to select whether he wants to have a global, all inclusive, maintenance factor for the whole room, or whether he wants to determine the respective maintenance factor for every luminaire / luminaire arrangement. The easiest way, which is the method used in early DIALux versions, is to use the classical method.

After a room or exterior scene was added to a project, the user can make the maintenance choice in the Property Page.

The screenshot shows the 'Maintenance plan method' dialog box with the 'Reference' dropdown menu open. The dropdown menu lists the following application examples:

- Very clean room, low yearly usage.
- Clean room, 3-year maintenance cycle.
- Exterior installation, 3-year maintenance cycle.
- Interior or exterior installation, high pollution.

The 'All inclusive' radio button is selected.

Fig. 84 Edit room data – Selection of a reference value for the maintenance factor

For the classical method the reference application examples are listed which appear in Mr. Stockmar article "Maintenance factor - theory and practise" in Licht 6-2003 from table 1. Of course the user can also enter any other value of maintenance factor in the maintenance factor field.

After choosing a luminaire, the user can place it in any arrangement. Also there is access to technical details of the luminaire.

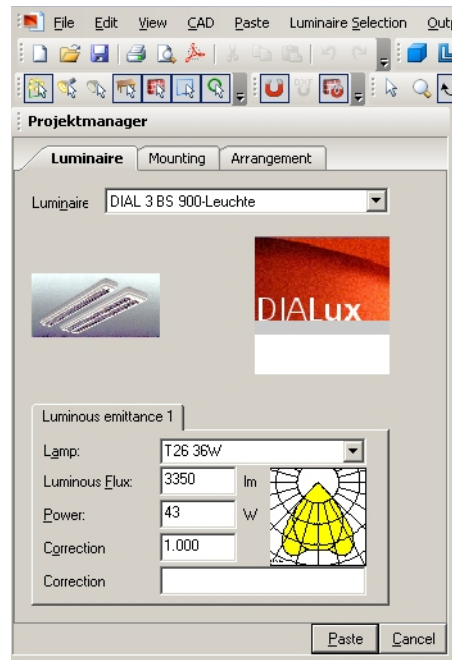

Fig. 85 Technical data of the placed luminaire

Because the luminous flux and the correction factor have an influence on the number of luminaires required these values can be edited here.

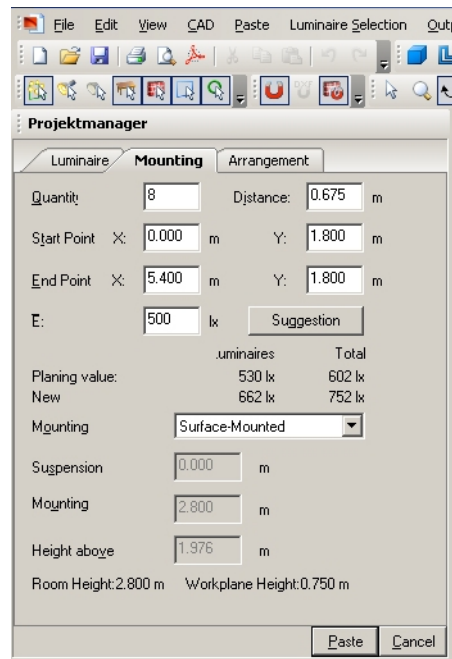

Fig. 86 Determination of the luminaire number of pieces

In DIALux the utilisation factor method is defined by the CIE to determine roughly the right number of luminaires for all luminaire arrangements. By using this method the expected initial illuminance as well as the maintained illuminance is indicated. Additionally, the initial and maintained value for the whole room is likewise indicated. The user can see immediately the contribution from this luminaire arrangement compared with the

whole layout of luminaires. In this case the values are different because other luminaires are in the room.

In the outputs the maintenance factor is shown as before on different output pages. For example, like here on the page "Maintenance plan".

The "classical" method is the default method when a new room is added.

Project 1



07.09.2005

Operator
Telephone
Fax
e-Mail

Room 1 / Maintenance plan

Regular maintenance is essential for an effective lighting installation. It is the only way to limit the light loss over the installation's life time.
The minimum values of the illuminance specified in the EN 12464 are maintenance values, i.e. they are based on a new value (at installation) in a maintenance to be prescribed. The same is of course true also for the values calculated in DIALux. They can therefore be reached only if this basic maintenance plan is diligently carried out.

General room information

Environment conditions of room:	Normal
Maintenance interval of room:	Annually

Line Arrangement / DIAL 3 BS 900-Leuchte

Effect of reflecting room surface:	small (k <= 1.6)
Flux distribution:	Direct
Maintenance interval of luminaires:	Annually
Luminaire type:	Closed IP2X (acc. CIE)
Annual burning time (in 1000 hours):	2.58
Replacement interval lamps:	Annually
Lamp type:	Tri-phosphorus fluorescent lamp (acc. CIE)
Spot lamp replacement:	Yes
Room surface maintenance factor:	0.94
Luminaire maintenance factor:	0.82
Lamp lumen maintenance factor:	0.93
Lamp survival factor:	1.00
Maintenance factor:	0.72

Field Arrangement / DIAL 3 BS 900-Leuchte

Effect of reflecting room surface:	small (k <= 1.6)
Flux distribution:	Direct
Maintenance interval of luminaires:	Annually
Luminaire type:	Closed IP2X (acc. CIE)
Annual burning time (in 1000 hours):	2.58
Replacement interval lamps:	Annually
Lamp type:	Tri-phosphorus fluorescent lamp (acc. CIE)
Spot lamp replacement:	Yes
Room surface maintenance factor:	0.94
Luminaire maintenance factor:	0.82
Lamp lumen maintenance factor:	0.93
Lamp survival factor:	1.00
Maintenance factor:	0.72

Please observe the corresponding instructions of the respective manufacturers when maintaining luminaires and lamps.

Fig. 87 Output – Maintenance plan

Extended method for determining maintenance factor

The user can determine if required also the maintenance factor for a singly used luminaire (arrangement). The extended maintenance method must be selected from the room Property Page.

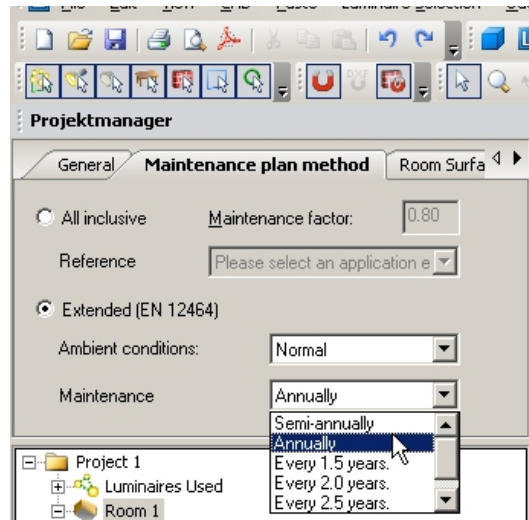

Fig. 88 Selection of the determination of the enlarged maintenance factor

For the room or the exterior scene the ambient condition is chosen. Here the user can select beside three given situations *clean*, *normal* and *polluted*, *very clean* which appears in the Trilux book "Planning help 12464". Next you pick the room maintenance interval.

After the selection of a luminaire, the user can place this in any arrangement. You also have access to technical details of the luminaire. This Property Page is identical with the one associated with the easy method.

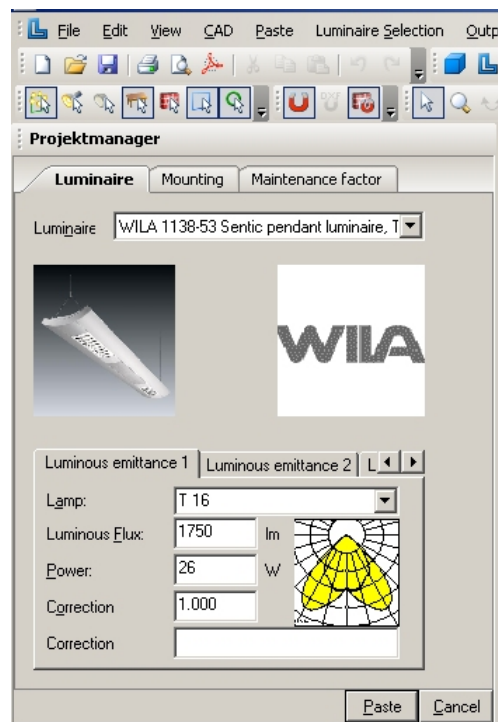

Fig. 89 Technical settings of luminaires with different luminous emittances

If you use a luminaire with several (different) luminaire emittances, (LEO, Light Emitting Object), you can set each LEO lamp choice and correction factor.

Both the initial illuminance and the maintained illuminance will be indicated as in the easy method. Also the initial and maintained illuminance of the whole room is shown. The user can see the contribution of this luminaire arrangement compared with the layout in the whole room. In this case the values are different because other luminaires are in the room.

The screenshot shows the 'Projektmanager' dialog box in DIALux, with the 'Mounting' tab active. The interface includes a menu bar (File, Edit, View, CAD, Paste, Luminaire Selection, Output) and a toolbar. The 'Projektmanager' window has four tabs: 'Luminaire', 'Mounting', 'Arrangement', and 'Maintenance factor'. The 'Mounting' tab contains the following fields and values:

- Rows: 3
- Luminaires per Row: 4
- Start Point: X: 0.000 m, Y: 0.000 m
- End point: X: 5.400 m, Y: 3.600 m
- E: 500 lx
- Buttons: Suggestion
- Table:

	Luminaires	Total
Planning value:	1713 lx	1906 lx
New	2608 lx	2849 lx
- Mounting: Pendant
- Suspension: 0.500 m
- Mounting: 2.300 m
- Height above: 1.494 m
- Room Height: 2.800 m
- Workplane Height: 0.750 m

Buttons at the bottom: Paste, Cancel

Fig. 90 Determination of the number of required luminaires

To access the Property Page *Maintenance factor* right click on an item below Luminaires in the *Inspector*, for example Field Arrangement or Individual Luminaire, then from the context menu select Edit maintenance Factor. All parameters can be edited associated with maintenance factor for this luminaire. If a luminaire has several LEOs, their parameters can likewise be individually edited.

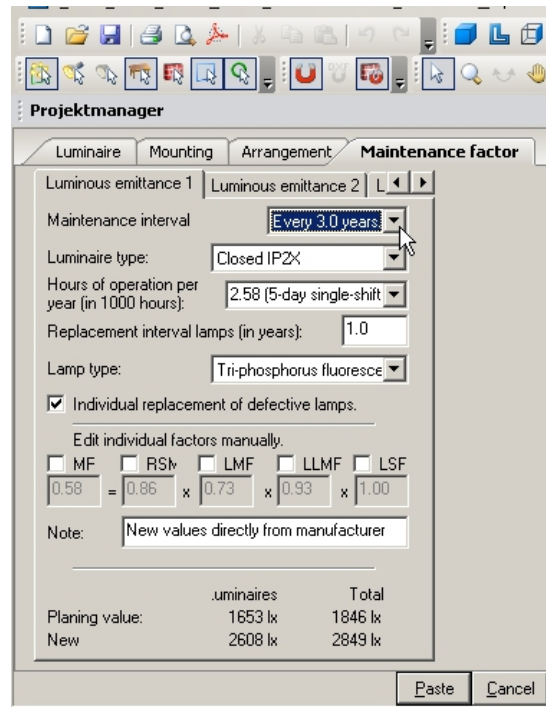

Fig. 91 Property Page Maintenance factor

On this Property Page the user can optimize the maintenance factor for the luminaire arrangement. If the luminaire manufacturer has defined maintenance parameters for this luminaire in his PlugIn or his ULD-file, this will be marked in the field *Luminaire type* and, also if it is available, under *Lamp type*. The maintenance factor depends on the ambient conditions (already defined in the Property Page of the room), the mounting height (because of room index k is defined using mounting height), the hours of operation (insert at this point) and the lamp and luminaires maintenance interval (define also at this point). If the luminaire manufacturer has defined no parameters, the user can choose under luminaire type and lamp type in the drop down lists from the CIE example data. If you want to use other factors for some reasons, you can mark the checkbox in the lower area above the individual factors.

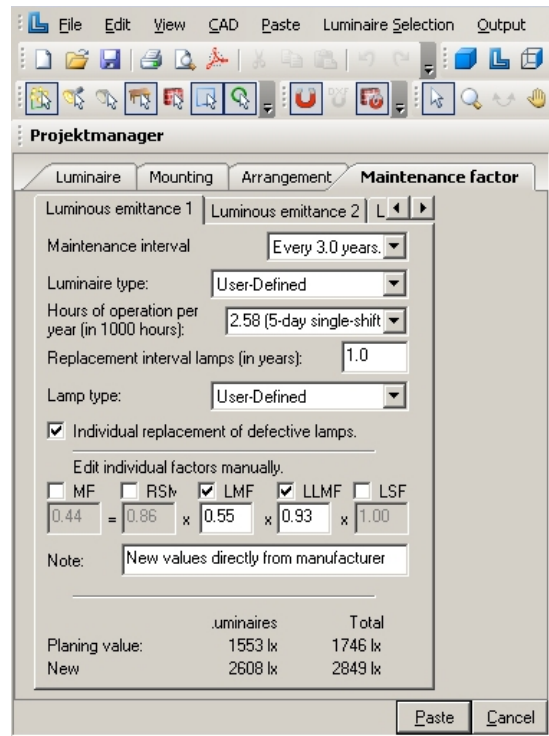

Fig. 92 User-defined maintenance factors

For those maintenance factors which you have selected (LMF or/and LLMF) the lamp type or luminaire type is selected on *User-defined*. Now you can insert directly the factors and a relevant remark.

On this Property Page you also have the overview for maintained and initial illuminance of the whole lighting system as well as this special arrangement. Therefore you are able to optimize the maintenance plan with regard to the number of luminaires and maintenance work.

With another arrangement in the same room the values of the whole illuminance and those of the respective arrangement of course vary.

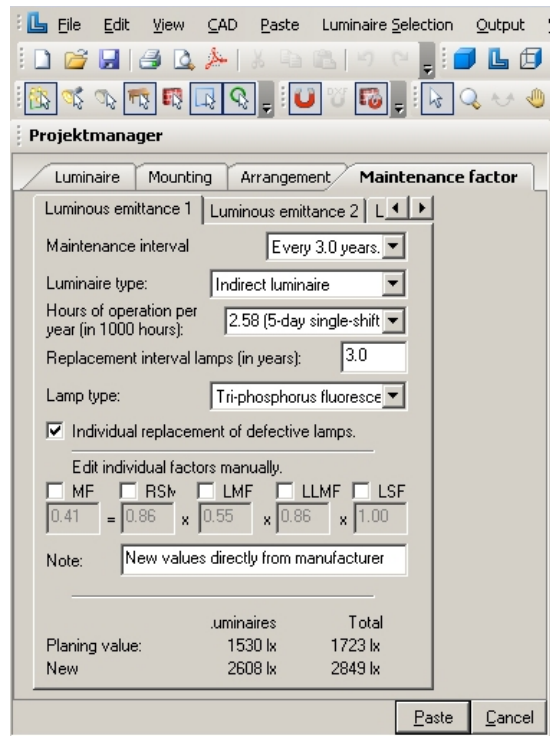

Fig. 93 Insert another arrangement in the same room

Now an optimum number of luminaires can be determined here for the project as a whole.

The maintenance factor also can be seen in the CAD view. Because luminaires in certain room zones can be subjected to different conditions, for example higher pollution or different operating hours, the maintenance factors of the individual luminaires can be shown in the CAD view. Local differences in maintenance factor consequently can be easily understood. You can display the maintenance plan factors either in the menu → view or in the menu bar in the CAD window.

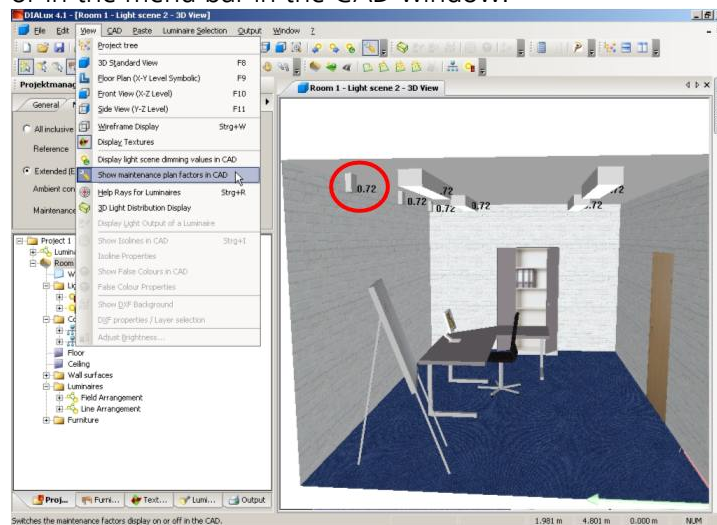

Fig. 94 Show maintenance factors in the CAD via menu

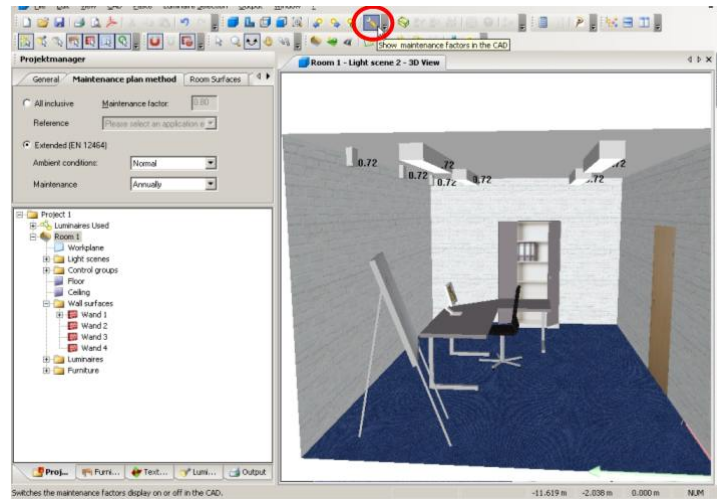

Fig. 95 Icon "Show maintenance factors in the CAD"

The user has the ability to edit the maintenance factors from the menu *Edit*

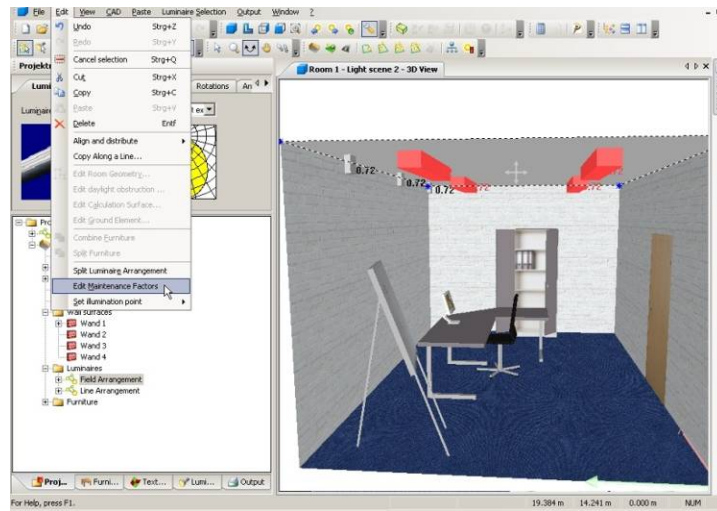

Fig. 96 Menu Edit – Edit Maintenance Factors

or in the context menu of the luminaire arrangement.

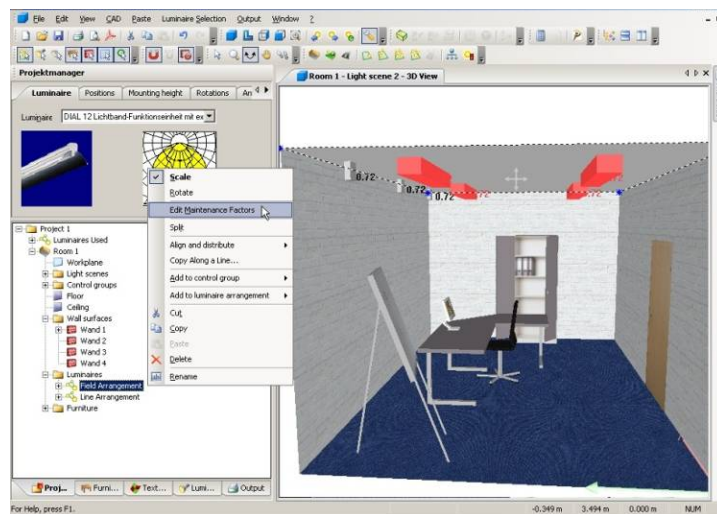

Fig. 97 Context menu of the luminaire arrangement - Edit Maintenance Factors

Also in the floor plan the ascertained maintenance factors can be shown. Perhaps more importantly the output *Maintenance Plan* is added as a new output in DIALux.

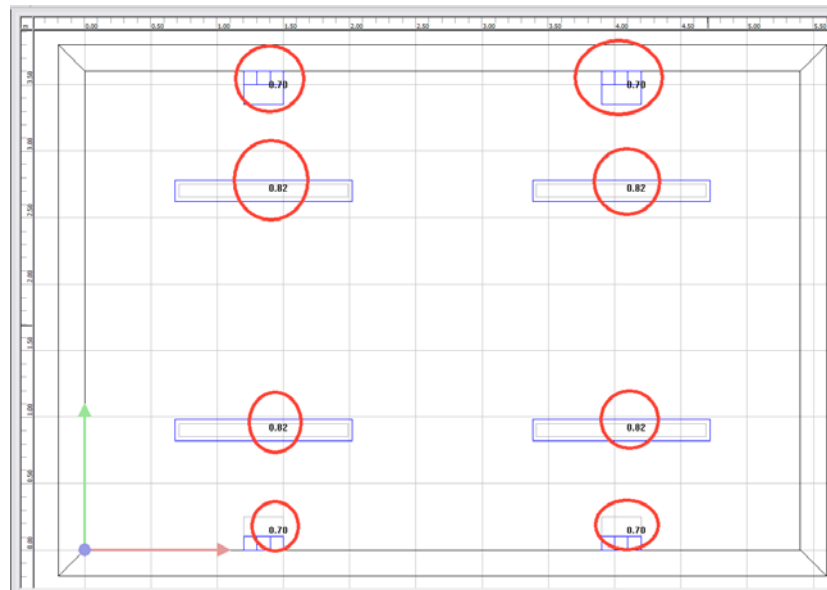

Fig. 98 View of the maintenance factors of individual luminaires in the CAD

With DIALux it is possible to save the maintenance plan as a *.RTF file.

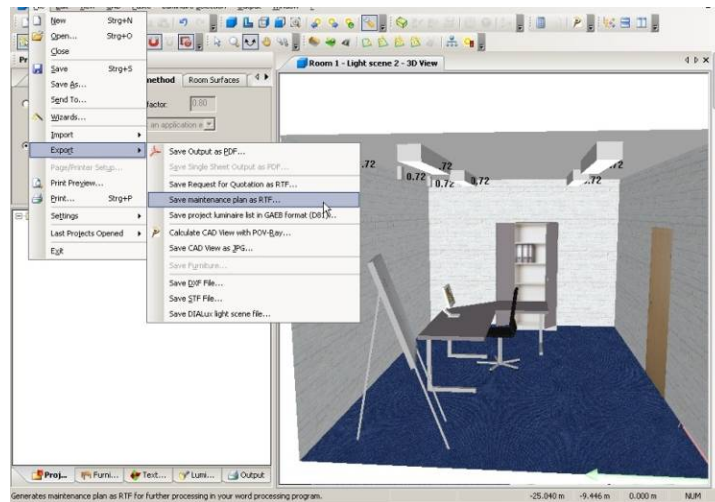

Fig. 99 Export of the maintenance plan

In the *Room Surfaces* tab you can specify the reflection properties for ceiling, walls and floor. If you change the reflection properties for the walls, you have to consider that always all walls of the room will be changed together.

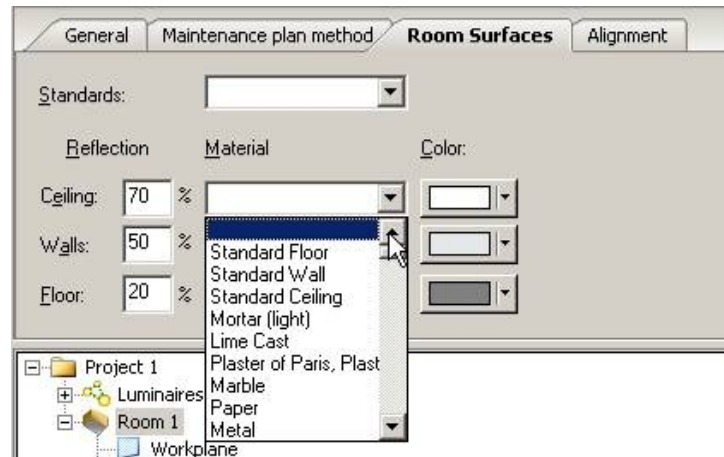

Fig. 100 Edit room data – Room surfaces

Deviation of north from
the Y-axis

The *Alignment* tab allows the setting of the north direction in relation to the Y-axis. For the room or the exterior scene the north direction can be set. To show this clearly, the north arrow is drawn near the coordinate origin.

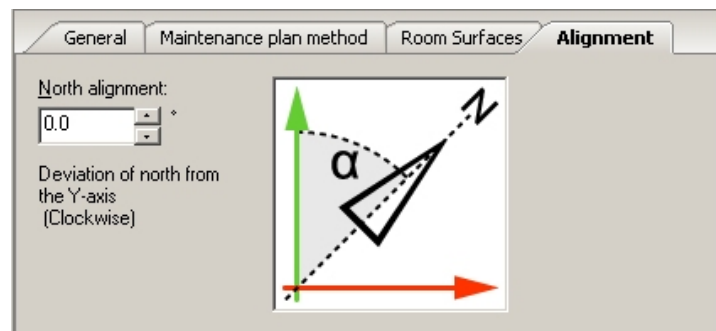

Fig. 101 Edit room data - Alignment

Modify Properties of Individual Walls

Select a wall in the 3D view, so that it is indicated in red. Alternatively in the *Project manager* you can select the corresponding wall and then similarly it is indicated in red. As soon as you marked an object, the properties of the wall selected will appear in the *Inspector*.

Here you can change the name of the wall and you can display the output results. If a shadow is displayed after the calculation, e.g. in the 3D rendering, you must define the calculation grid in the outputs. A better display will result from a smaller calculation grid (by increasing the number of points). Naturally the consequence of a smaller calculation grid is an increase in the calculation time for your computer.

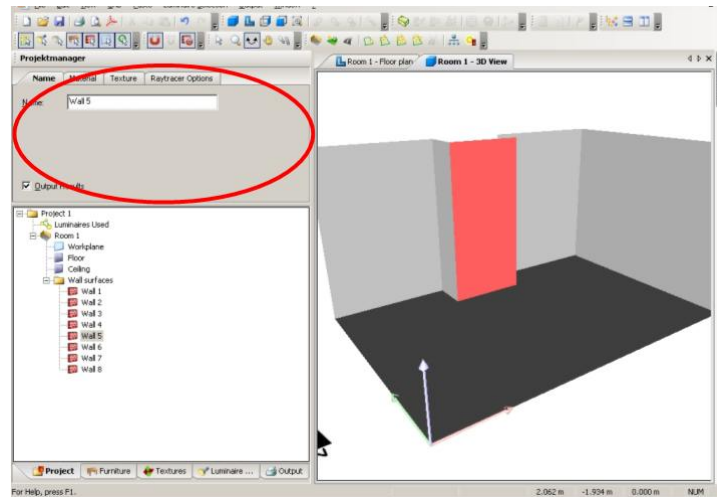

Fig. 102 Properties of a wall – Name

On the second tab –*Material*– you adjust the material properties for the wall. The *reflectance* value changes in response to new material choice. You can specify an alternative reflectance directly in the *reflectance* box.

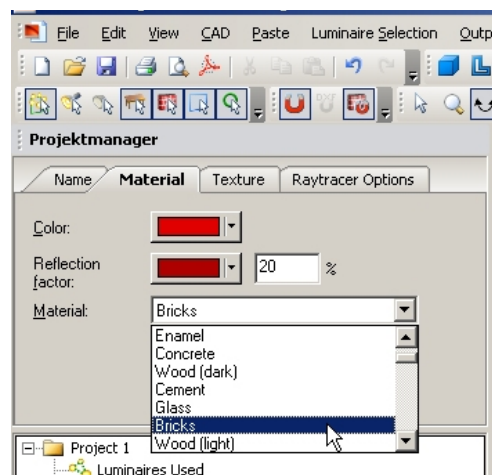

Fig. 103 Properties of a wall – Material

In the *Texture* tab you can adapt the texture properties, if you have placed a texture on the wall (see page 93). In the *Raytracer Options* tab you can adjust the properties, which the wall should have if you have started the Raytracer provided by DIALux.

Insert Room Elements

Modify a Room with Room Elements

With DIALux you have the ability to modify the room with room elements. Clicking on the object tab of the Project Manager at the bottom of the screen shows a tree of elements and objects contained in folders that can be introduced into a project. For example selecting standard elements with the left mouse button displays a preview window of the elements available. Clicking on an element in the preview window shows geometric parameters in the inspector. You can either edit these parameters in the inspector to the values you need or later makes changes to the size and scale after putting the element into the project.

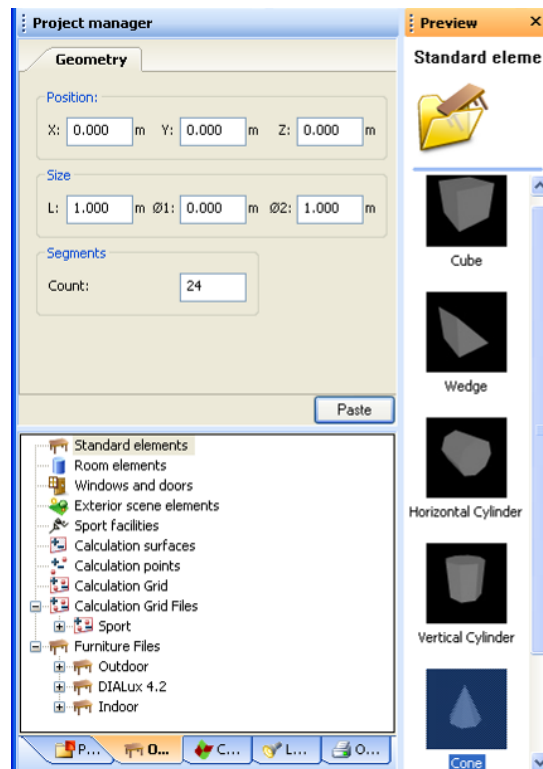

Fig. 104 Inserting a standard element

In the case of a cone it can be truncated by entering a size for $\Phi 1$ other than zero. The cone is constructed with a regular polygon as its base, the segment count is the number of sides the polygon has. Clicking on Paste adds the element to the project in the CAD window at the origin. Alternatively the Drag and Drop technique can be used, left mouse click on the element in the preview and while holding the button down drag to place the element in either the 3D view or plan view whichever is open.

A right click on the element in the CAD window shows a context menu that includes scale and rotate. With scale selected the bounding box around the element can be stretched in the X and Y direction to scale it. In the 3D view and elevation views the height can be scaled by hold the control key on the keyboard and stretching the bounding box in the Z direction. With rotate selected in the context menu the handles connected to the origin of the element can be rotated. Any geometric changes made are shown in the inspector for the element under the Geometry tab. There is a Calculations options tab that allows, if the use as decorative object box is checked, for the object to cause no obstruction to light in the space with regard to output results. The object does however appear as a 'decorative object' in any 3D rendering.

Another example is that you can insert a *sloped ceiling* that cuts the existing wall surfaces and creates new surfaces called "ceiling 2". The other room elements like the flat ceiling become a part of the room as well and you can create new room surfaces at the same time.

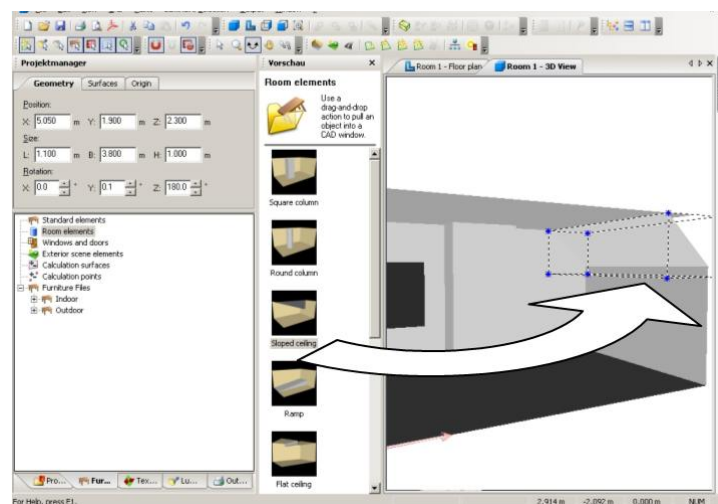

Fig. 105 Edit rooms – Insert room element

To insert room elements into a room, first of all you have to open the *Furniture tree*. Then select the file *Room Elements*. All room elements are displayed in the centre of the window. You can insert these simply by Drag & Drop into the 3D view or the ground plan view.

You can likewise create the room elements in the ground plan view. Particularly the scaling option of the room elements is easier in the ground plan view. You can scale and rotate the room element simply by using the mouse.

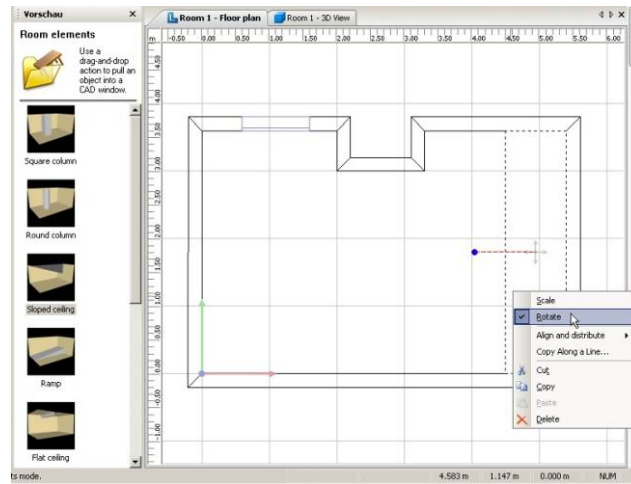

Fig. 106 Edit rooms – Edit room element

With DIALux it is possible to insert the following room elements. Naturally you can also combine these. As soon as a room element overlaps another, the invisible part is no longer considered in the calculation.

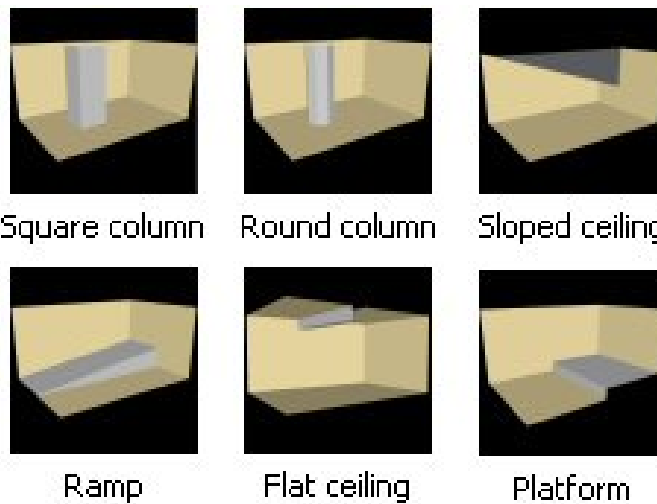

Fig. 107 Edit rooms – DIALux room elements

The room elements *vaults* are new in DIALux 4. Further possibilities for the construction of complicated ceiling forms have been improved. Now it is also possible to copy vault ceilings.



Fig. 108 DIALux room elements – Vault

Vault and half vault

The well known and well-tried room elements of DIALux are complemented with new objects, dome and half dome. These elements can be scaled or rotated just like any other room elements. They combine with the room. Their surfaces are automatically recognized as ceilings, so that ceiling mounted luminaires snap automatically to dome or half dome surfaces.

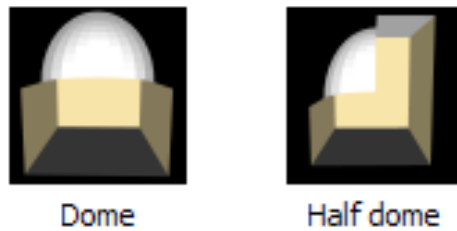

Fig. 109 DIALux room elements – Dome and half dome

Insert via Property Page

You can also insert objects numerically by entering coordinates in the furniture Property Page within the *Inspector*. Select the object in the furniture tree, enter the desired position in the *Inspector* and click on *Insert*.

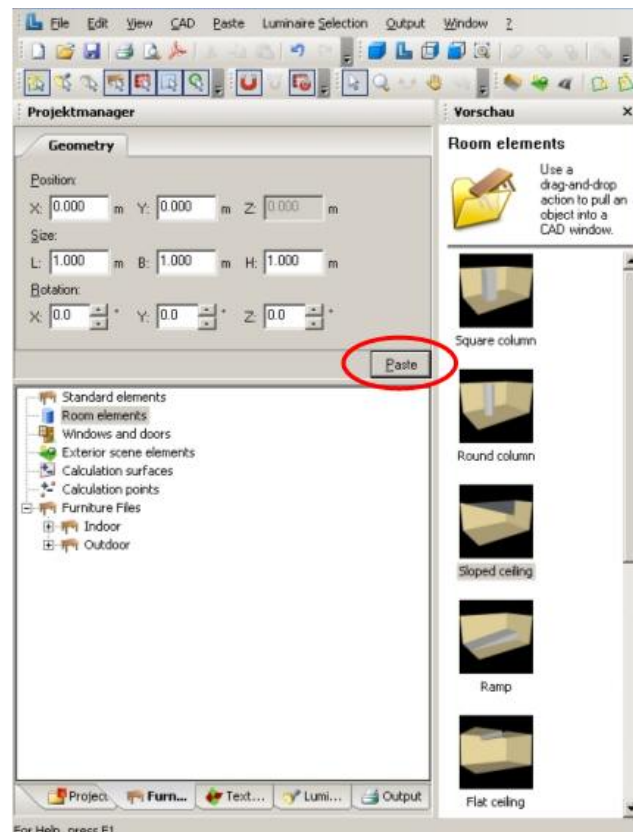

Fig. 110 Edit rooms – Insert room elements via Property Page

Insert Furniture

Insert Furniture

You can insert furniture into the project in the same way as room elements by using Drag & Drop or the Property Page.

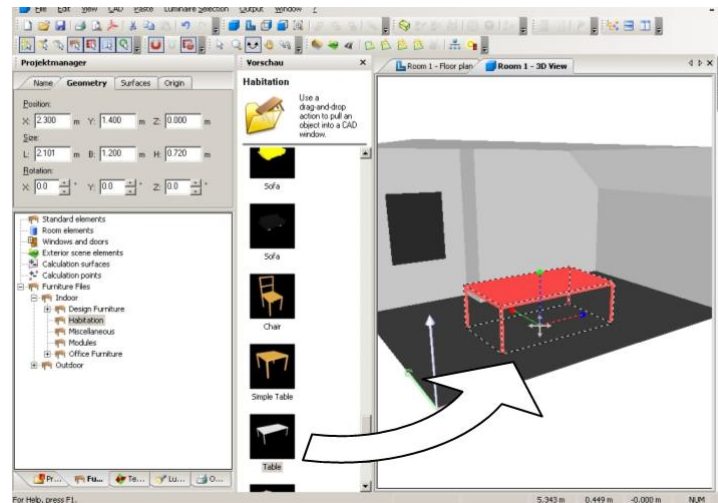

Fig. 111 Drag and Drop of furniture

Insert via Property Page

You can also insert objects numerically by entering coordinates in the furniture Property Page within the *Inspector*. Select the object in the furniture tree, enter the desired position in the *Inspector* and click on *Insert*.

Create Furniture

You can create your own furniture by combining standard bodies. The following example of a small shelf describes the procedure.

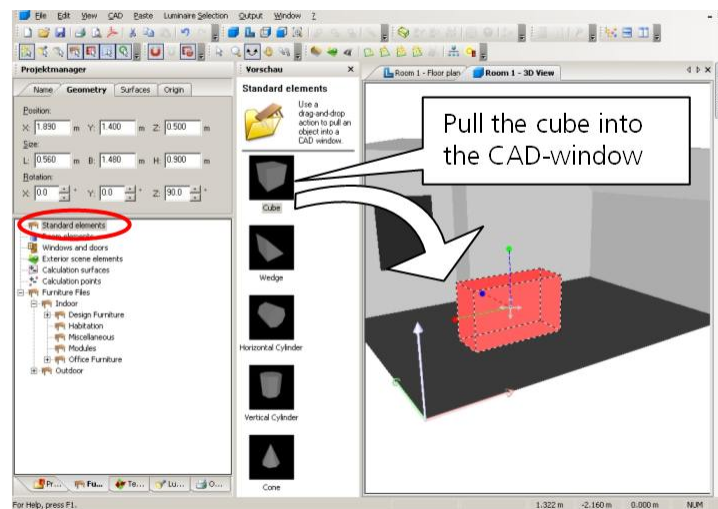

Fig. 112 Create furniture – Standard bodies

Modify the geometry of the cube in such a way that it corresponds to a bottom shelf by using the Property Page.

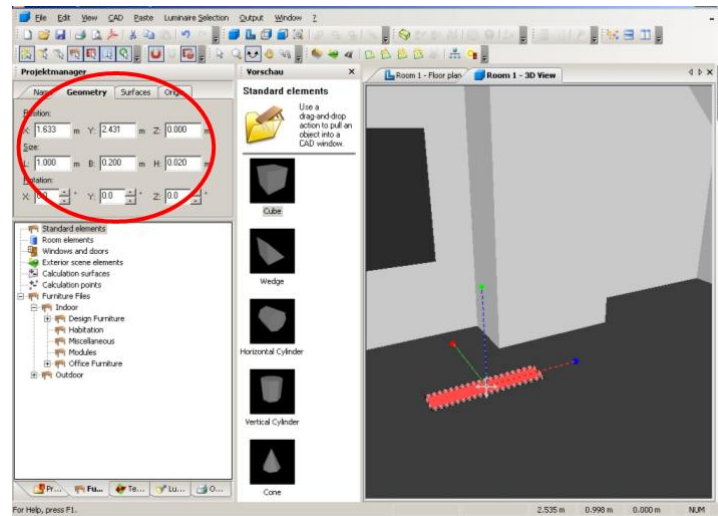

Fig. 113 Create furniture – Modify the dimensions

Subsequently you can copy the bottom shelf and move it to the desired position. Possibly the height (Z-axis) will need modifying.

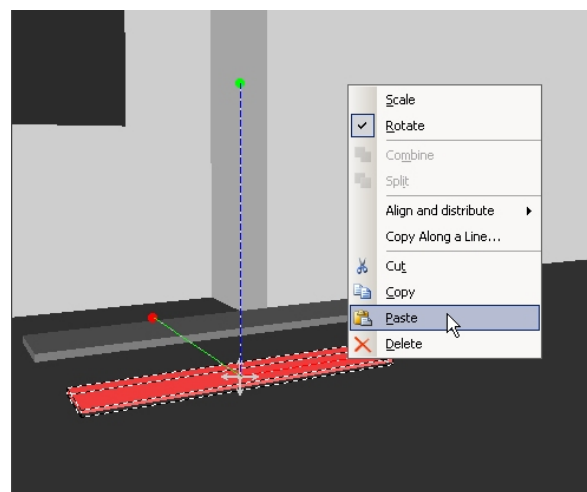

Fig. 114 Create furniture – Copy

Afterwards you can generate the side panels and position them correctly. Subsequently select all side panels and shelves and combine them via the right mouse button. Combining is very important particularly for the calculation. Otherwise DIALux will include each surface into the calculation, even those surfaces which are actually covered and no longer visible.

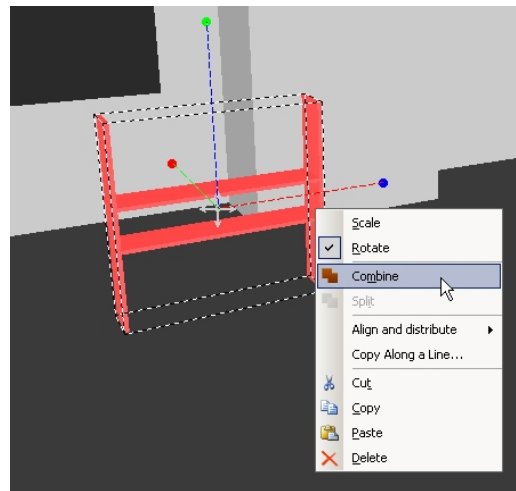

Fig. 115 Create furniture – Combine

You can save furniture by using the context menu *File* → *Export* function → *Save Furniture*. That way it is possible to use furniture in another project again.

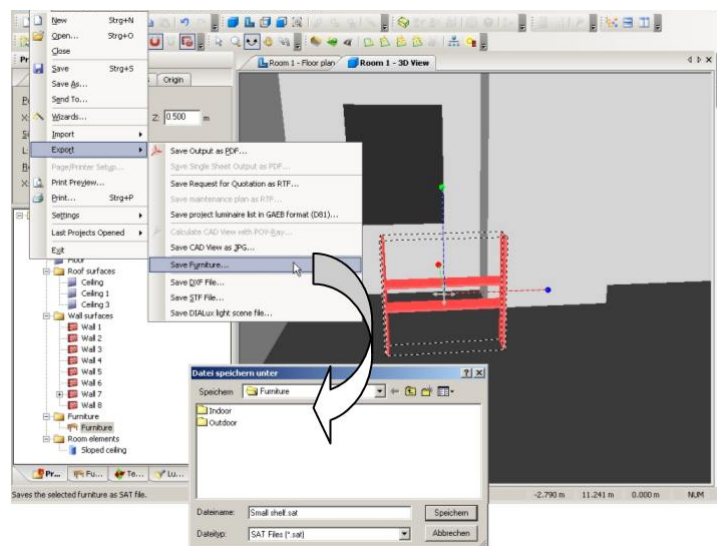

Fig. 116 Create furniture – Export furniture

Now you can see your saved furniture in the furniture tree (if necessary this must be updated once by changing into the *Project manager* and then back again into the furniture tree). From there you can move them at any time, like all other furniture, into a room or exterior scene via Drag & Drop into your CAD windows (see also page 180).

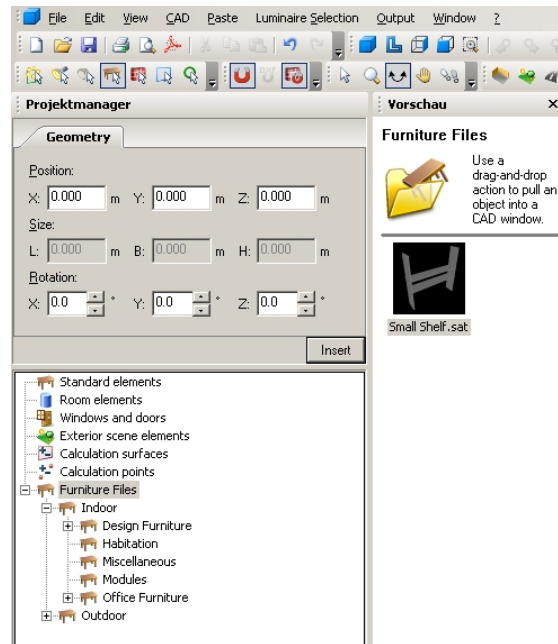

Fig. 117 Create furniture – Saved furniture

Import Furniture and 3D model Files

You can import furniture files from other programs, e.g. Auto-CAD over the menu *File* → *Import* → *Furniture Files*. DIALux imports furniture files with the ending SAT (*.sat) and ending m3d (*.m3d).

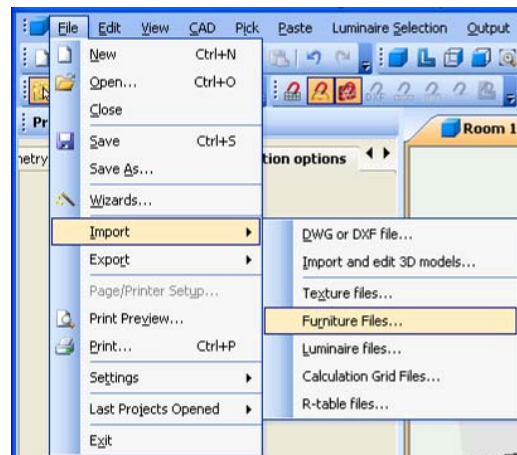

Fig. 118 Import furniture files

Also 3D model files can be imported with the ending 3ds (*.3ds). To do this select menu *File* → *Import* → *Import and edit 3D models* to start the importing wizard. The wizard has a few steps including:

- File selection
- Selection of object data
- Specifying measurement units
- Setting origin of object

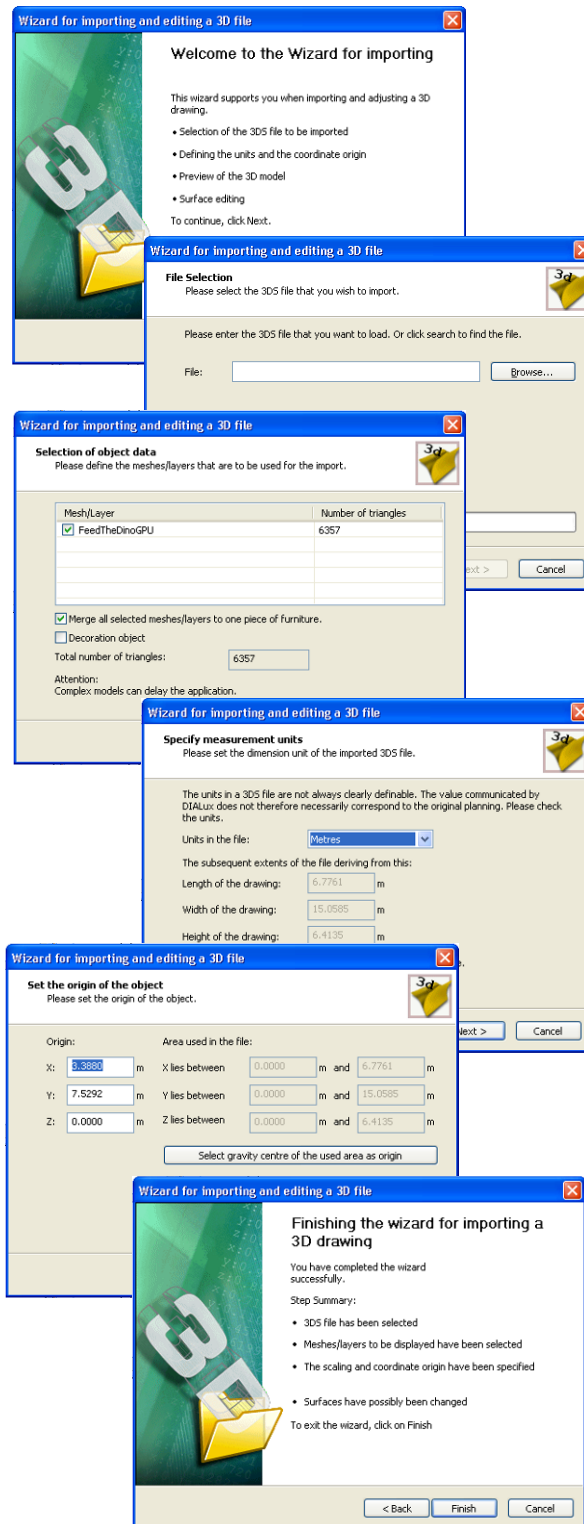

Fig. 119 Importing 3D wizard

Extrusion Volumes

New to the standard elements is the furniture “Extrusion Volume”. To create an extrusion volume, just drag and drop the object into a room or an exterior scene. A cube with edge lengths 1m x 1m x 1m is displayed. Simultaneously the familiar room editor is shown in the *Inspector*. With this editor you can assign the extrusion volume any polygonal form you like, both numerically by

inserting coordinates and graphically by dragging points or lines or by inserting coordinates with right clicks. After the extrusion volume's form is defined, any extrusion height can be selected.

An extrusion volume can be rotated, combined, subtracted or saved as new personal furniture. Of course, colours and textures can be assigned to the volume's surfaces.

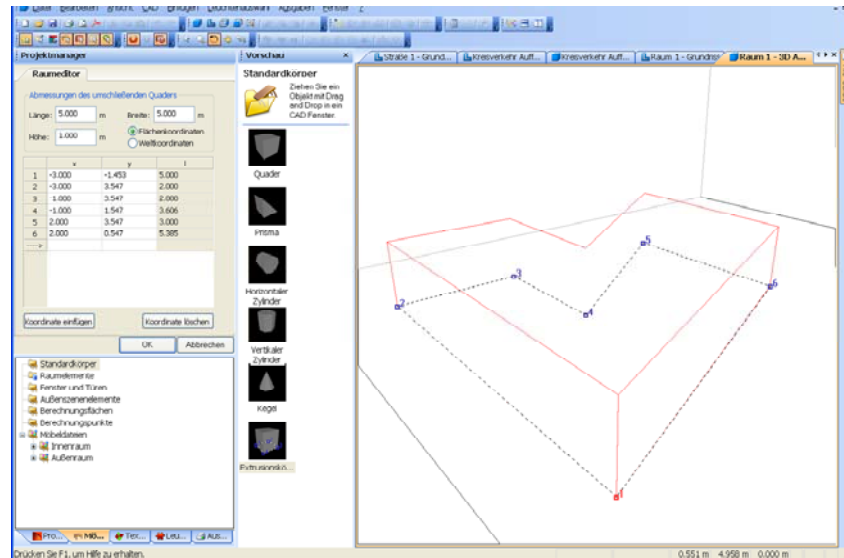

Fig. 120 Creating an extrusion volume

Glass objects

Glass objects have been introduced in DIALux 4.9 in combination with the Ray-Trace preview. Contrary to other objects glass objects can be masked or unmasked.

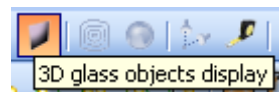

Fig. 121 Mask and unmask glass objects

By combining two or more glass objects the feature of transparency will trail off.

As a matter of fact glass objects include the same features as the common standard objects. Therefore scaling, rotating and moving is possible. For the usage in the Ray-Trace preview and in PovRay glass objects feature predefined propositions for transparency and reflection.

Please use glass objects for modelling room-divider, showcases and many more glass objects.



Fig. 122 Examples for objects of glass (before and after using the Ray-Trace preview)

Subtraction of Objects

Subtraction of objects is a helpful tool to create complex furniture. Similar to room elements subtracting areas from a room, you can subtract one or more objects from one other object. Objects can be standard elements, extrusion volumes, furniture or imported SAT objects. The resulting object is what remains after the one object is subtracted from all other objects. The following example shows a polygonal extrusion volume with a cone sticking in it. The cone will create a depression in the volume. To achieve that, both objects are selected and the command "Subtract furniture" is executed. "Subtract furniture" can be found in menu "Edit" or in the context menu that is displayed after right clicking the selected objects. The command shows a Property Page, in which you can select the one object; all other objects are subtracted from. Pressing button "Subtract" executes the command. The CAD window afterwards displays what is left of the extrusion volume.

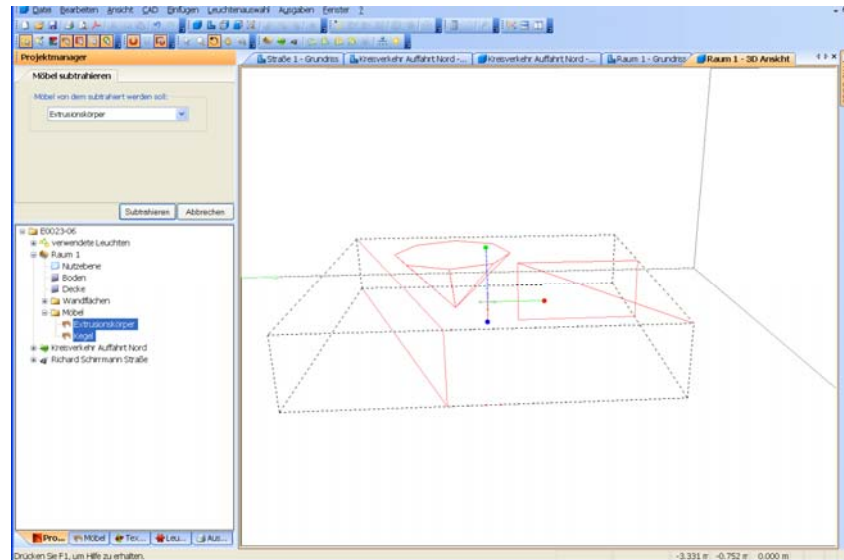

Fig. 123 Subtractions from a volume

If the cone goes completely through the extrusion volume, a hole is created. If the newly created furniture is split, all objects, even those which have been subtracted, are restored.

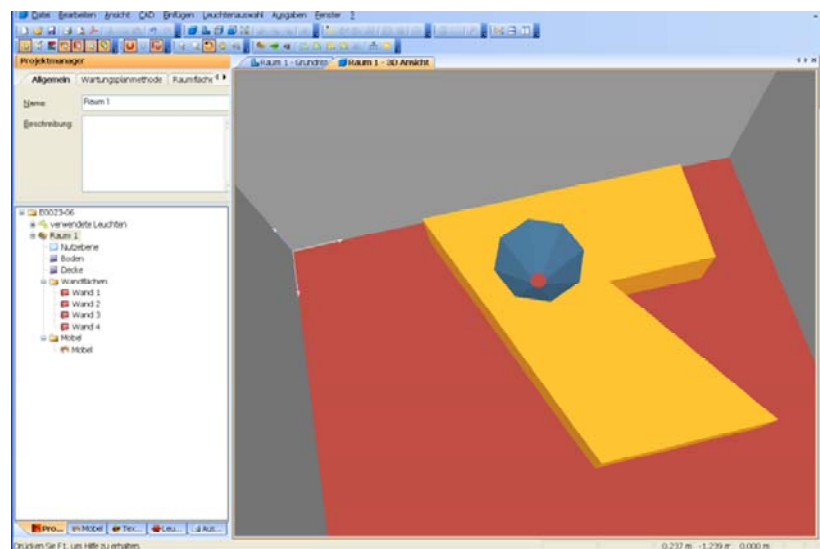

Fig. 124 Resulting volume

Selecting Single Surfaces

Time and again it is necessary to work on single surfaces of an object. With complex objects with very many surfaces, it may take a lot of time to find the desired surface in the surface list of the object's Property Page. To simplify this essentially, you can select a single surface now graphically. Just right click the object in the desired surface in the CAD and choose "Select this surface" from the context menu. The desired surface is selected in the Property Page and can be assigned a colour, a texture, material and so on.

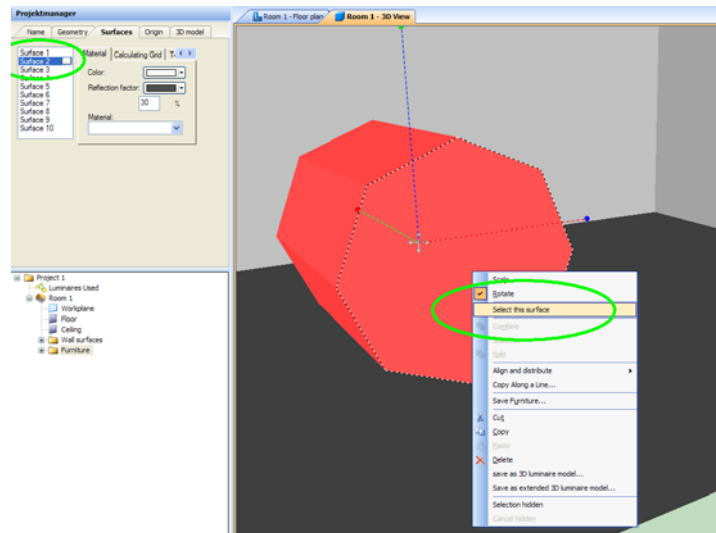

Fig. 125 Selecting specific surfaces from a volume

Windows and Doors

Windows and doors can also be inserted into the layout via "Drag & Drop". They can only be positioned in walls.

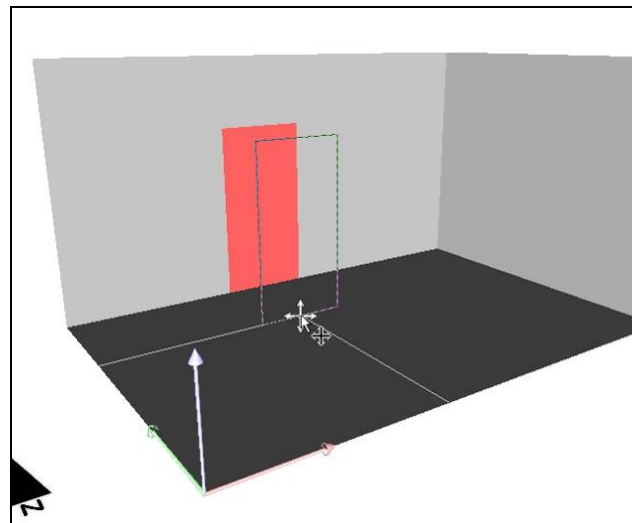

Fig. 126 Drag & drop for windows and doors

Since windows and doors can only be placed in walls, the door in this illustration is automatically placed vertically in the nearest wall. These objects automatically face the right way.

Decoration Objects

With furniture and models you can create attractive projects to improve the visual impression. However, especially nicely designed furniture often exist of numerous surfaces whereby the calculation time of the project is increased. If these models concern of purely

decorative used objects which have no influence on the photometrical results, this additional calculation time is unnecessary. Decoration objects are treated under unequally as the usual models in DIALux. Indeed they are completely taken into account into the calculation of the direct light. However the indirect part is determined strongly simplified. Decoration objects also reflect no light. Good examples of decoration objects can be among other things like desk utensils, shelve contents or plants. The simplified calculation is often sufficient to receive a good visual impression, while the calculation time is clearly reduced.

Insert Decoration Objects

Decoration objects are inserted just as other furniture in DIALux. After you have placed the furniture you can select the tab "calculation options" in the inspector and activate the checkbox "Use as decoration object".

Alternatively you can mark in the project tree one or several models and open the context menu via right click. Choose the menu "Use as decoration object".

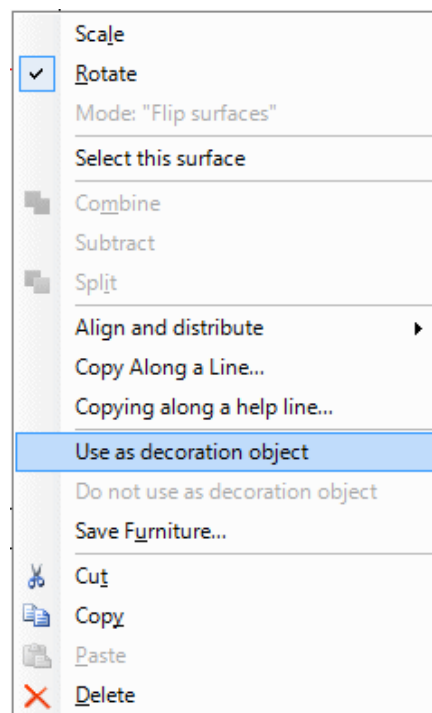

Fig. 127 Context menu – decoration object

Decoration objects are marked with another symbol than furniture in the project tree.

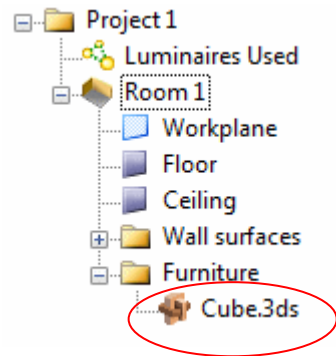

Fig. 128 Decoration object in the project tree

Calculate with Decoration Objects

In the calculation dialogue you can define whether the decoration objects are treated as those or as normal models.

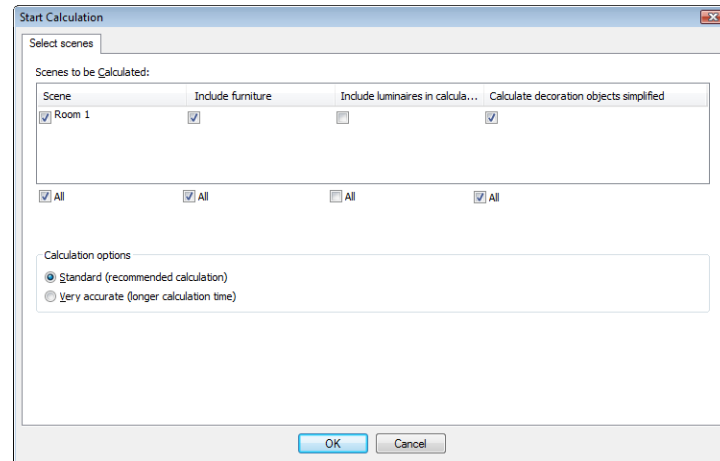

Fig. 129 Calculation dialogue

Insert Textures

Insert via Drag & Drop

You can insert textures into your project with Drag & Drop.

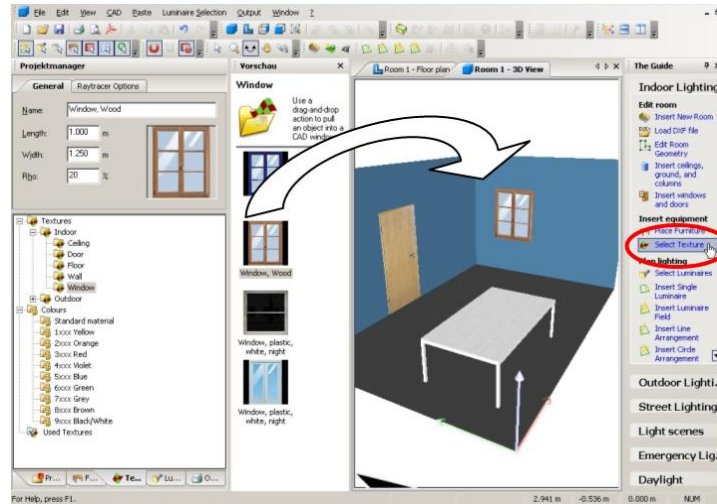
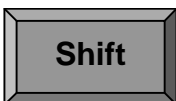

Fig. 130 Insert textures via Drag & Drop

If you want to assign a texture to a surface, you simply go to the colours tree, select the desired texture or colour, hold the left mouse button and drag it to the CAD and drop it onto correct surface. You can place textures and colours on every "real" surface (furniture, walls, windows, doors, ...) but not on a "virtual" calculation surface. The light colours and colour filters can only be used on luminaires. Inside of an object (room or furniture) the texture is assigned to all surfaces with the same colour or texture. For example if the walls in a room have the same colour and you drag a masonry texture to one wall, the texture is assigned to all other walls at the same time.

In order to occupy only one surface of an object with the texture, hold the **SHIFT** key!



In order to occupy all surfaces of an object with the texture, hold the **CTRL** key!

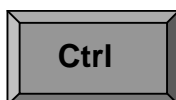

When you want to assign the texture only to one surface, you can hold the *Shift*-key while you drop the texture to the surface.

When you hold the *Ctrl*-key while you drop the texture onto a surface, all surfaces (e.g. the walls, the ceiling and the floor of a room) get the same texture.

Edit Placed Textures

When a texture is not placed properly on a surface, you can correct this afterwards.

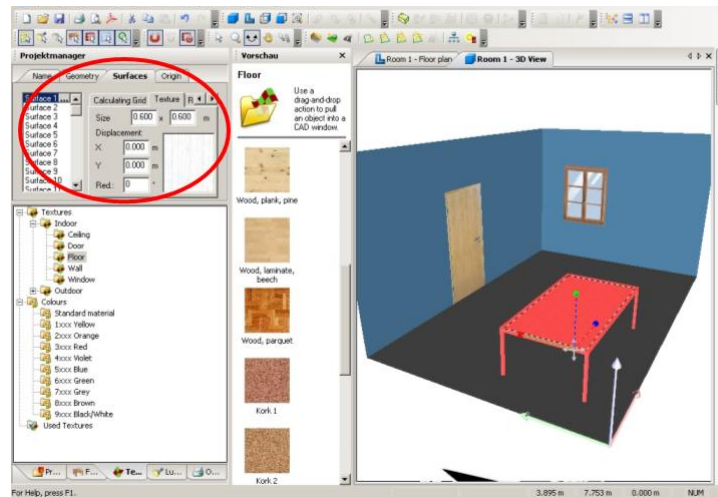

Fig. 131 Edit textures on an object

Select the object in the CAD view. The *Inspector* shows the Property Page *Surfaces* of the object with the additional information about the texture. If for example the texture has the wrong rotation, you can correct it on the Property Page *Texture*; similarly you can scale or move the texture.

If you want to mirror a texture, you can easily do it by entering a minus (-) symbol in front of the length or the width (or both) of a texture. You can use it only for the texture placed on a surface not for the texture itself.

Delete Textures

You can remove a texture from an object by using the *Eraser* from the texture tree on the corresponding object. Thereby the object gets assigned again the origin colour.

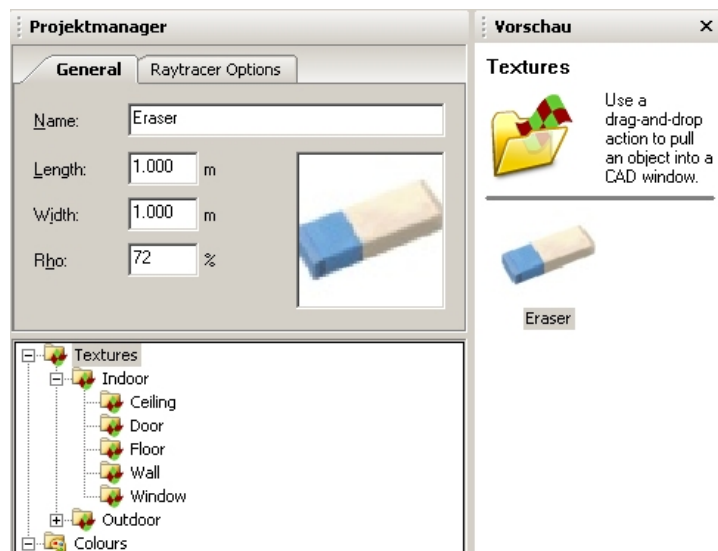

Fig. 132 Delete textures

Import Textures into the Texture Tree

You can insert your own textures or images into the texture tree. DIALux supports files in *.bmp, *.dib, *.jpg and *.gif-format.

Textures can be inserted via Drag & Drop into the texture tree. To import a new texture into the texture tree, open the texture tree and start the Windows Explorer. Now you can drag the image file from the Windows Explorer into the wanted directory of the texture tree. DIALux automatically converts the image file into the needed format. The reflection factor is calculated using the RGB-values. The size defaults to 1m x 1m. You should check these values and correct them if necessary.

With the menu *File* → *Import* → *Texture Files* you can use a dialogue to copy the textures into a directory of the texture tree.

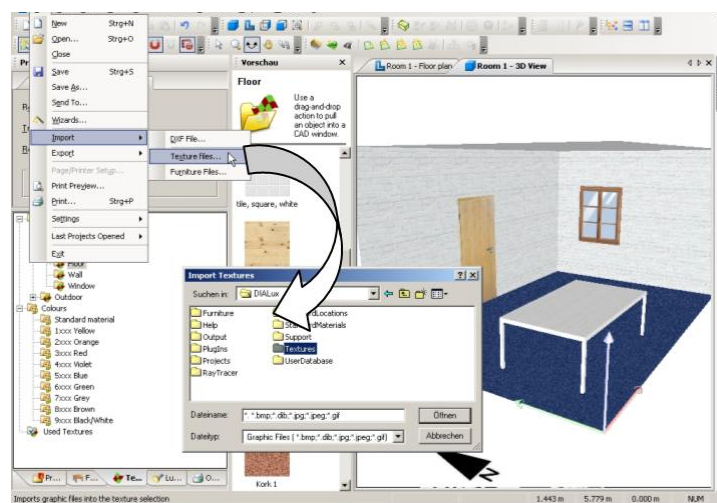

Fig. 133 Import textures into DIALux

Within the colour tree textures can be moved, copied or deleted. Also subfolders can be created or deleted. Just make a right click on the desired object.

Edit Room Geometry with DWG or DXF-File

Please read chapter *DWG and DXF import and export* starting from page 281.

Material dialogue for surfaces

The material dialogue for a particular surface has been overworked completely in DIALux 4.9. To reach the material dialogue please directly select a surface (from an object, a wall etc.) or select the particular object, wall etc. and then click "Surfaces" in the project manager.

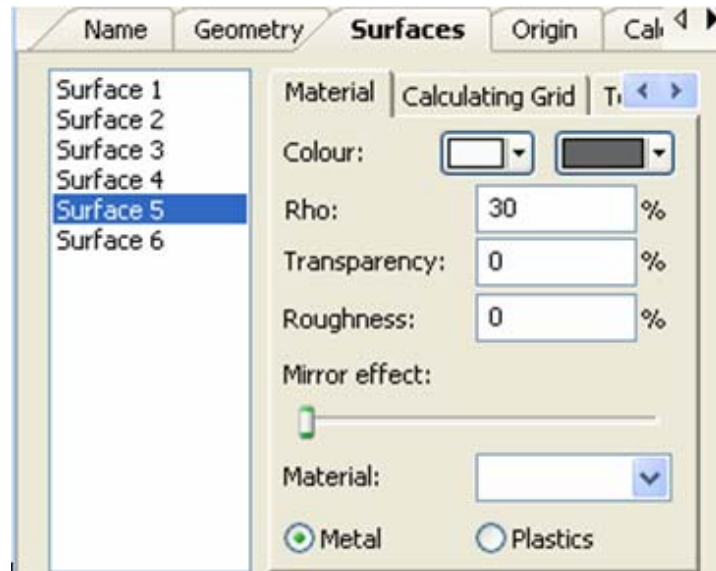

Fig. 134 Opening the material dialogue of a surface

Colour

In "Colour" you can define the colour of a surface. In the first list you will find the primary colour of your selected surface. Dependent on the reflection and the selected transparency you are able to choose a resulting colour in the second list.

Reflection (Rho)

The value for reflection (Rho) indicates how much of the arriving light is being reflected. Please mind that values over 80% are barely present in practical life. Therefore DIALux is limited to a value of 90%.

Transparency

The value for transparency shows, contrary to reflection, how much of the arriving light diffuses through a surface. In Raytracer preview and in PovRay Raytracer as well those surfaces will be visualised transparent. Please mind that the sum of transparency and grad of reflection cannot exceed 100%.

Calculation of transparency

DIALux 4.9 takes transparent surfaces into account for calculation. Please choose for the surface of an object or a material (e.g. the texture of a wall) a transparency between 0 and 100%. The selected value is taken into account by the DIALux calculation. Please be informed that solely the direct orientated part of transparency is calculated correctly! As a matter of fact it's unfortunately not possible to simulate dispersion like for example for using frosted glass.

This transparency cannot be visualised directly in the DIALux CAD. For a realistic visualisation please use the raytracer preview or the PovRay Raytracer.

Roughness

Roughness points up if and if yes, how much texture a surface features. Info: Roughness is only considered for mirroring surfaces and highlights.

Mirror effect

The orientated grad of reflection can be changed by using the integrated slider. A highly mirroring surface should be obtained with a high mirroring effect. Please mind that the mirroring effect is only viewable in the Raytrace preview and in PovRay Raytracer.

Info: The mirroring effect does not affect the calculation results.

Material

By selecting a standard material from the material list you can define your surfaces' properties for calculation in DIALux as well as for the Raytrace preview and PovRay Raytracer.

Metal / Plastics: Both feature different characteristics regarding reflection. Therefore please choose the appropriate settings for your surface(s).

Raytrace preview

Since DIALux 4.9 you are able to generate a preview of your actual rendering in different quality grades by the usage of the Raytrace preview. At first please calculate your actual project with DIALux and click next on the "Raytrace preview" symbol in the DIALux toolbar.

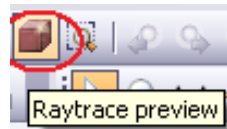

Fig. 135 Selection of the Raytrace preview

The DIALux inspector provides the user with two different settings' options for the Raytrace preview:

Quality:

The integrated slider allows you to set up the grad of smoothing edges from low to high. The higher you move the slider the more beautiful the rendering will get. As a matter of fact the calculation time will also increase fundamentally.

Highlights:

On reflecting surfaces high luminance, e.g. due to direct light from luminaries, could cause intense gloss effects. If these gloss effects should be paid attention to in your picture please select "Calculate highlights". As a matter of fact the calculation time will also increase fundamentally in this case. Additionally in some scenes there might not be any changes viewable. Therefore please choose this option carefully.

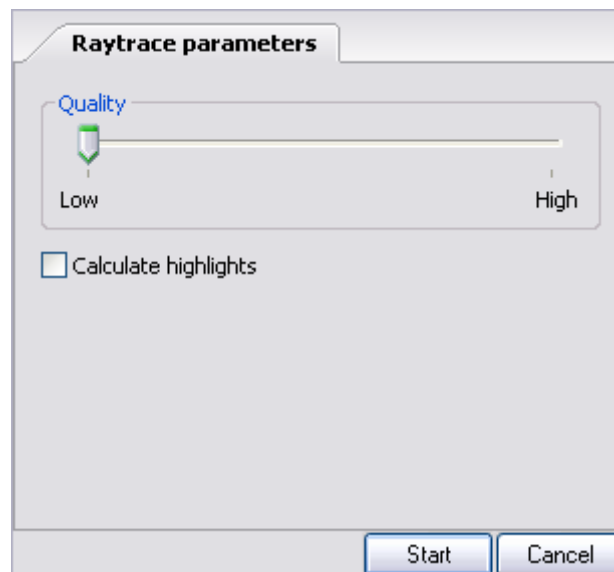

Fig. 136 Raytrace preview parameters

Our tip: Please generate a picture (rendering) in lower quality and without highlights first. Thus you will recognise very quickly if your chosen perspective meets your demands and furthermore if the whole scene is well accentuated. You can render a second picture with higher quality if you are satisfied with the results.

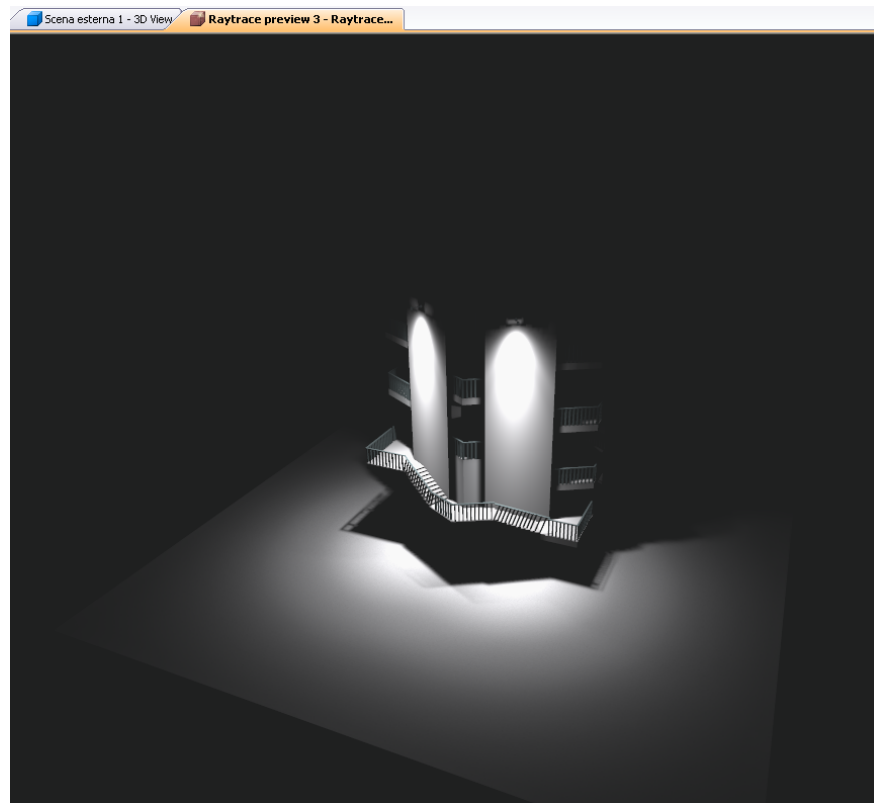

Fig. 137 Output of the Raytrace preview

Duplicate (Copy Rooms/Scenes/Streets)

Duplicate an Existing Room

An identical room can be created by clicking *Duplicate*. First select the original room in the tree, and then select the *Duplicate Room* command from the context menu.

Please note that the room information is duplicated (dimensions, materials etc.) together with the objects inside the room (luminaires and furniture).

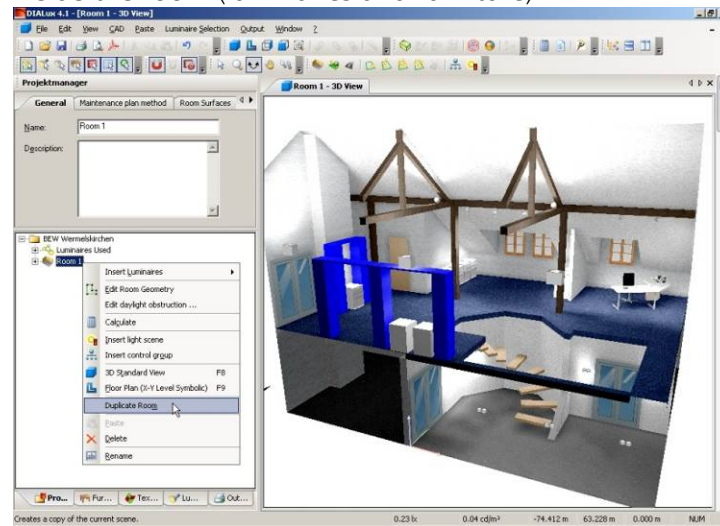

Fig. 138 Duplicate rooms

Insert and Edit Luminaires and Luminaire Arrangements

You can open the luminaire tree by clicking in *The Guide Select Luminaires*. In the luminaire tree you will see *installed Plugins* under DIALux catalogues. With one double-click on a name of a manufacturer you can open a Plugin. Under *not installed Plugins* you can find the DIALux project partners, whose Plugins are not yet installed. A double-click on the corresponding names of the manufacturers opens its internet page. There you can download the DIALux Plugin. Additionally telephone numbers and e-mail addresses are displayed. At the bottom of the list the last used luminaires are always indicated. This can be up to 20 luminaires of different manufacturers.

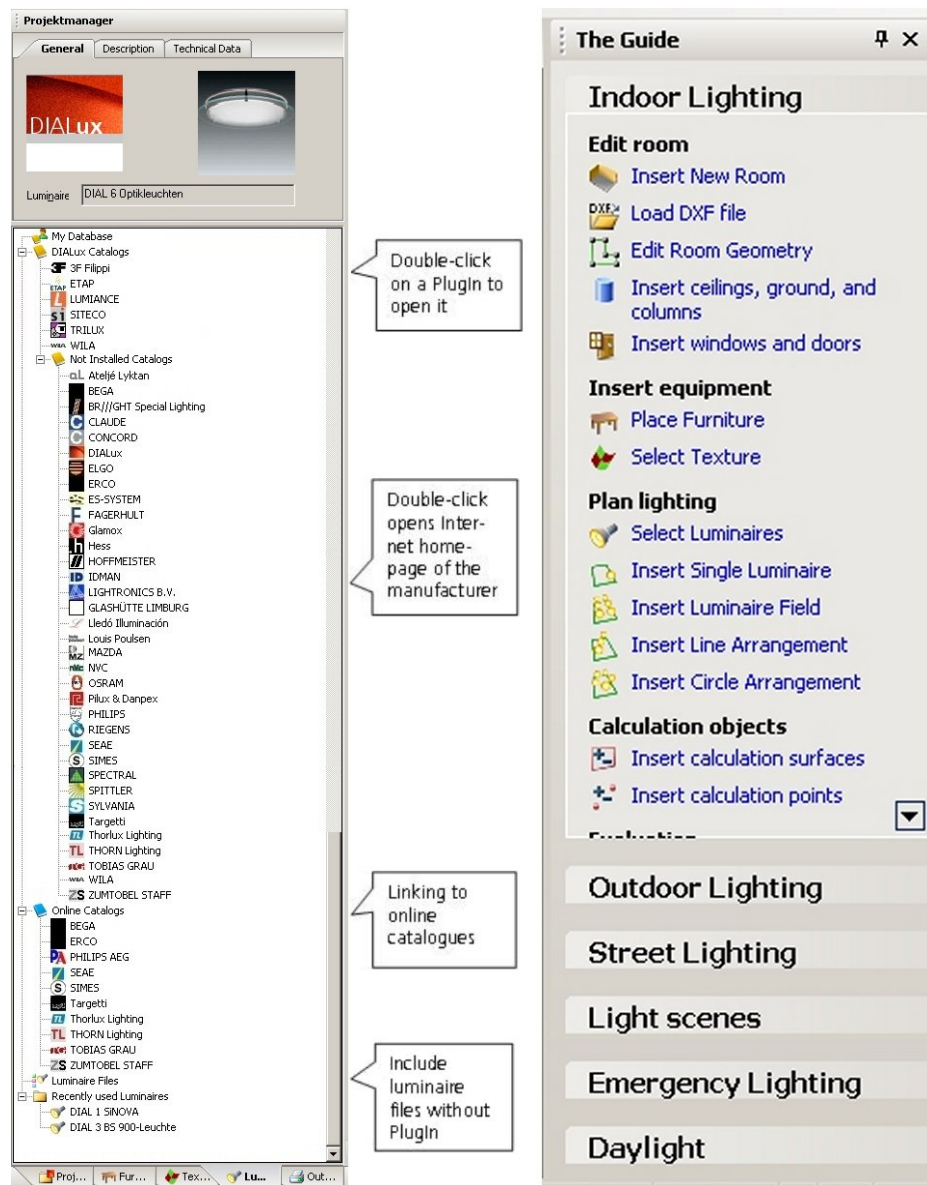

Fig. 139 Launch luminaire tree

Online Catalogues

In DIALux it is possible to insert luminaire files over so-called *Online Catalogues*, functioning similarly as installed PlugIns.

You can open an online catalogue by double-clicking on the corresponding symbol in the luminaire tree. Afterwards the online catalogue opens and you can insert a luminaire from the internet page of your manufacturer directly into your DIALux project. In this way you can constantly access current files of your manufacturer.

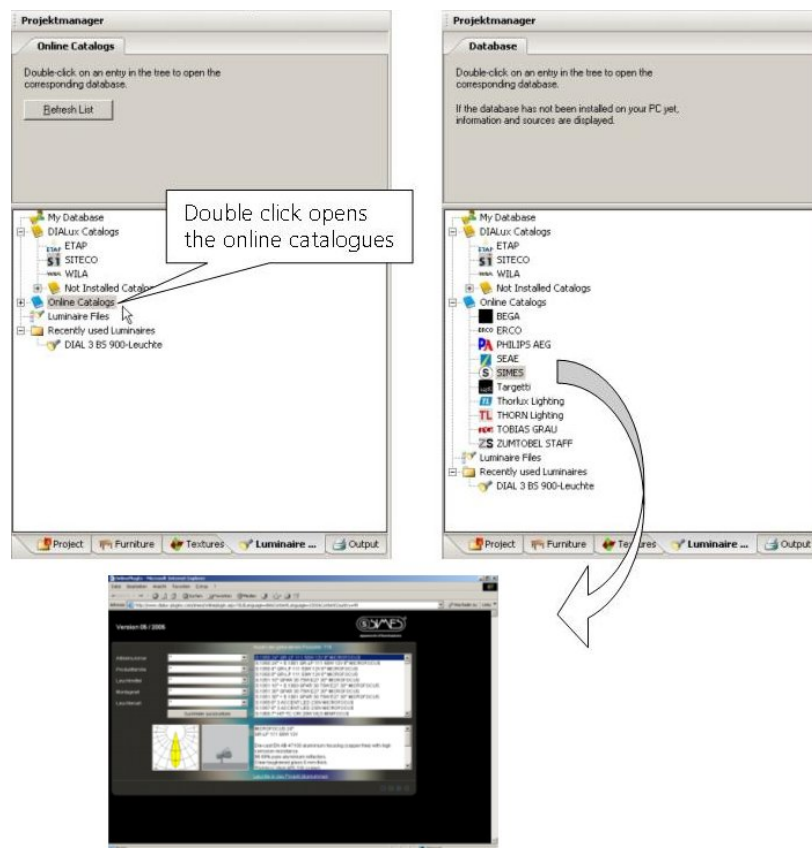

Fig. 140 Launch online catalogues

Hint: Inserting luminaires over the online catalogue works only if this service is offered by the corresponding manufacturer.

Individual Luminaires

Individual luminaires can be inserted into the room from the project or luminaire tree via Drag and Drop. Simply pull the luminaire from the tree to the room. The luminaire is inserted into the room at that position (X and Y coordinates) where you release the mouse button. The way it is inserted influences the arrangement type. Via Drag and Drop you can position luminaires only inside rooms.

In the future, some luminaire manufacturers will supply Plugins from which luminaires can also be positioned via Drag and Drop.

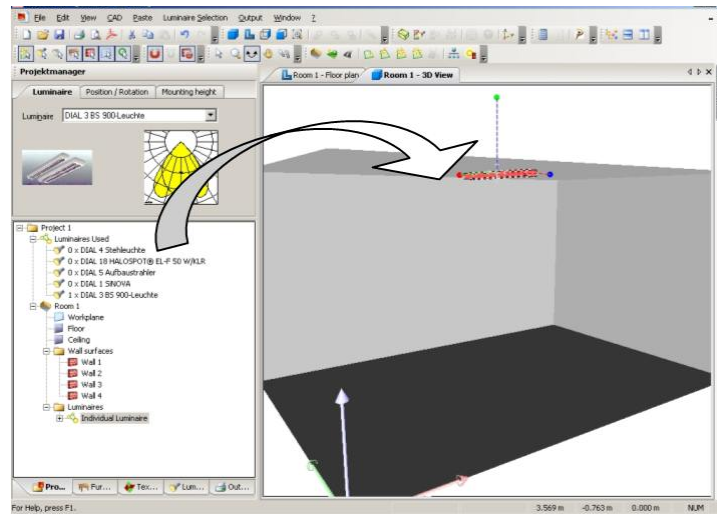

Fig. 141 Insert individual luminaires

If you click on *Insert Single Luminaire* in *The Guide*, a corresponding Property Page opens in the *Inspector*. In the CAD, the arrangement is highlighted by a rubber band lines, in the Property Page initial values are displayed and at the bottom of the Property Page the *Insert* and *Cancel* buttons are located.

Depending on the currently activated tab, you can adjust the *Position*, the *Rotation*, as well as the *Mounting height* of the arrangement. In the *Luminaire* Property Page you can select the luminaire to be positioned.

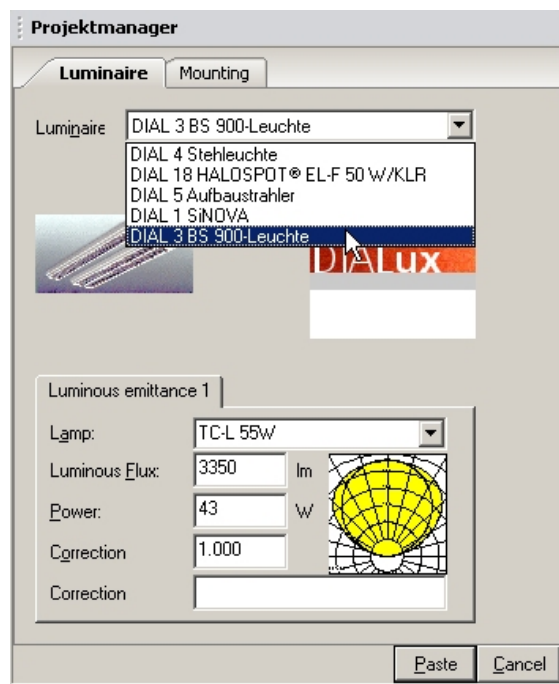

Fig. 142 Luminaire selection dropdown list

In the list displayed in the illustration, you can find the luminaires that you have inserted into the project, as well

as the last luminaires you have used. According to the *Mounting* tab you can make various settings for the mounting.

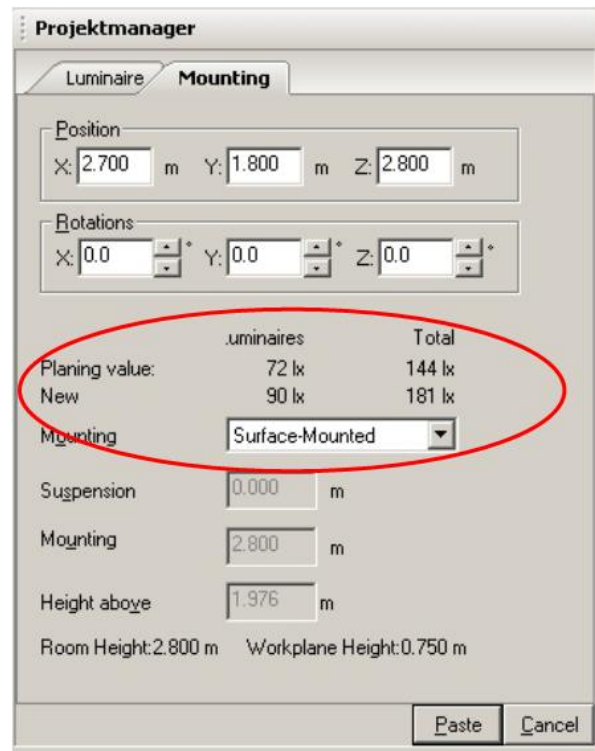

Fig. 143 Mounting tab

Additionally information is shown giving the maintained and initial illuminance due to these luminaires and due to the whole room.

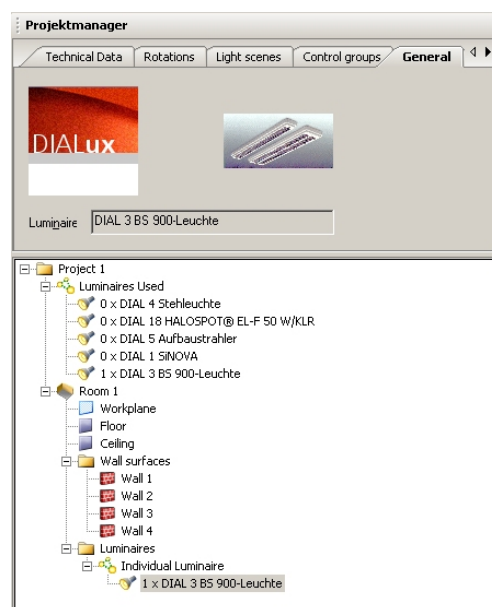

Fig. 144 Modifying the technical data of luminaires

To modify the *Technical Data* of the luminaires, these must have been inserted into the room. In the *Project manager*, the luminaires contained in the arrangement are listed beneath the respective arrangement type (An

individual luminaire arrangement in this case). If you select one of these luminaires, you can modify its technical data. If you select multiple luminaires in the CAD, you can modify the values of all selected luminaires.

Aligning Luminaires

In DIALux you can switch on *Help rays* for the *luminaires*. In the menu *View* you can find the function *Help rays for Luminaires*.

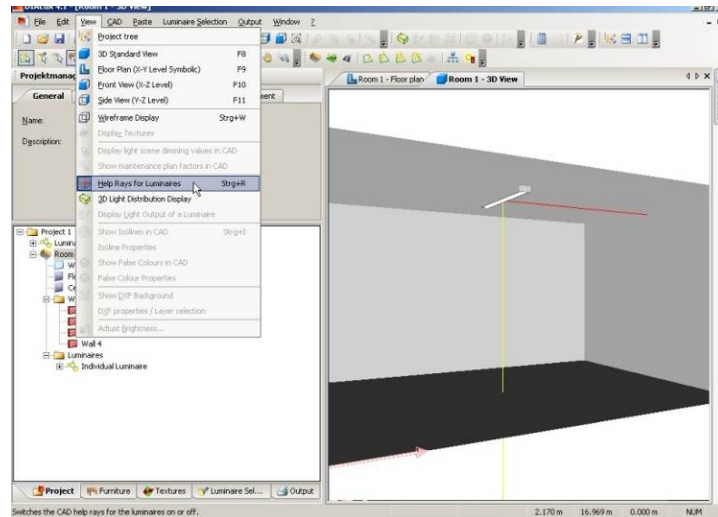

Fig. 145 Help rays for luminaires

When you click on this icon, a C0 arrow (red line) – which indicates the direction of the C0 plane – and a yellow line –degree of light radiation $\gamma = 0^\circ$ – appears at the inserted luminaires. The C0 planes of the luminaires always show towards the X axis, if it wasn't rotated.

The C0 level of luminaires with a rotation of 0° is directed lengthways in the positive X-axis. Gamma0 points vertically from the top to the bottom.

With DIALux you can switch on the *3D Light distribution curve*, (LDC). This function is useful to check the correct placement of luminaires with asymmetrical distribution.

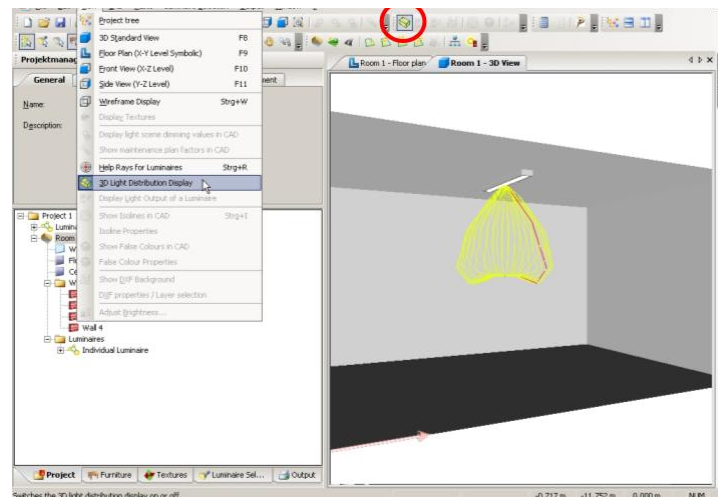

Fig. 146 Luminaires with 3D LDC

To show the LDC, click on the icon *3D Light Distribution Display* or select the menu *View → 3D Light Distribution Display*.

In DIALux the alignment of luminaires is improved with the function *Set illumination point*, which allows you to align the yellow help ray (gamma = 0) with any point on a selected surface.

The alignment of luminaires has further been simplified in DIALux. Beside the function of the alignment of the luminaires to C0, Gamma0 and C90, Gamma 0 the illumination point can be also aligned optionally to the maximum luminous intensity (I_{max}).

Set illumination point → align to I_{max} .

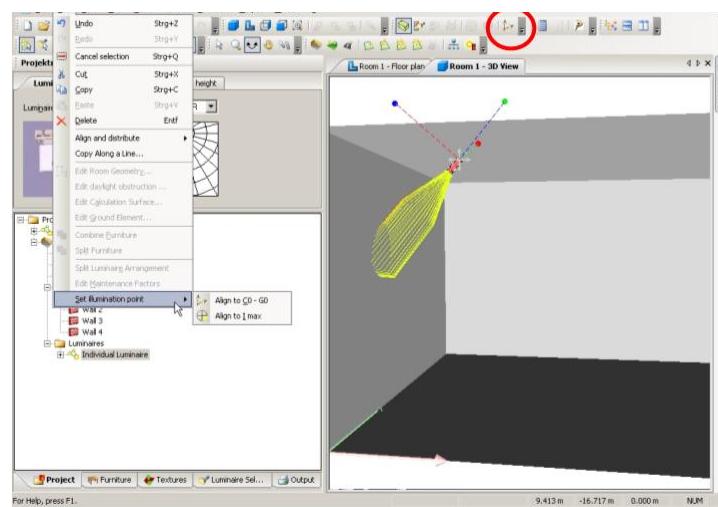

Fig. 147 Mouse mode to define illumination point

To set the illumination point, you have to select a *single luminaire* first. Maybe you even have to activate the single luminaire selection to select a luminaire inside of a luminaire arrangement.

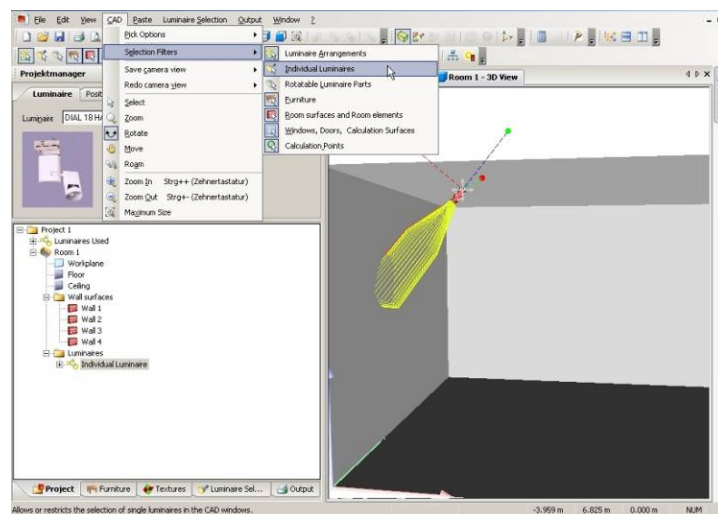

Fig. 148 Selection of individual luminaires

When you have selected the single luminaire, you can use the mouse mode *Set illumination point* and click on the position (surface or furniture) you want to illuminate.

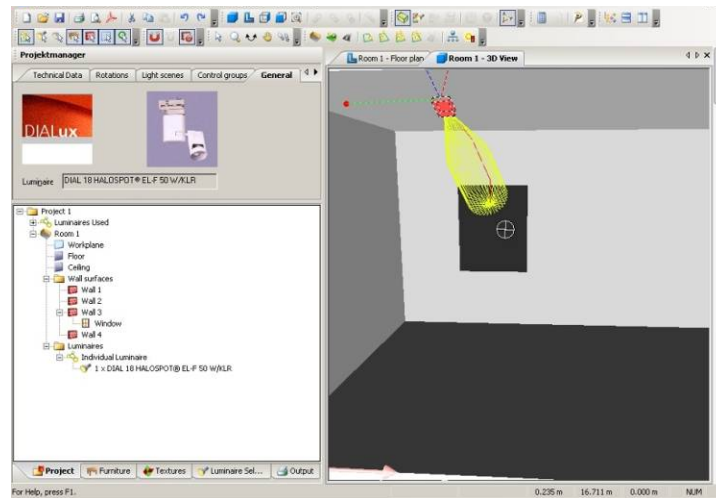

Fig. 149 Align a spotlight to a picture

Inserting Luminaire Fields

Luminaire fields can be positioned either by selecting the *Insert Luminaire Field* option in *The Guide* or the *Luminaire Arrangement Wizard* → *Field Arrangement* option. If you select a room and then perform a right-click, the context menu for that room opens. Here you can also select the *Insert* → *Field Arrangement* option. The Wizard sequentially queries all important parameters that must be entered.

If you use one of the options with which the luminaire field is entered manually, the *Inspector* displays, in addition to the luminaire field, a *Paste* and a *Cancel* button.

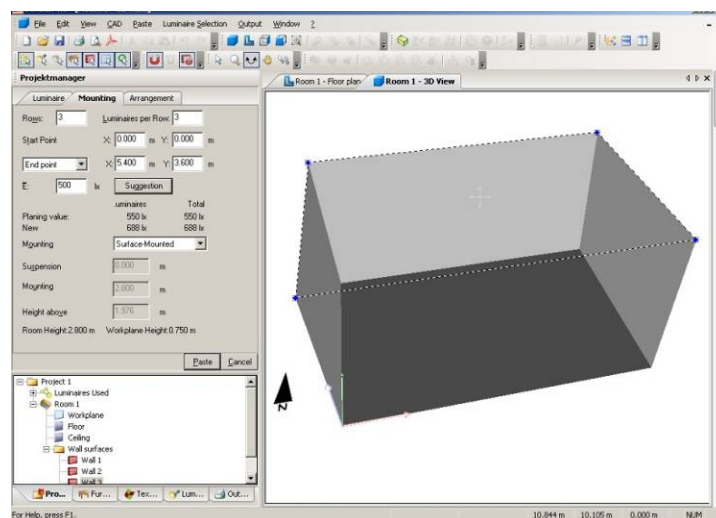

Fig. 150 Insert luminaire fields without wizard

Until you click *Paste*, only the rubber band indicating the field arrangement is visible. You can modify all

parameters in the Property Pages before or after inserting the field.

To edit a luminaire field, select it in the tree or in the CAD view. If you click on a luminaire in the field, all luminaires in the field are selected by default. If you wish to edit individual luminaires, you first have to change the selection filter (see Fig. 148).

The following filters can be selected (from left):

- Allow or restrict the selection of luminaire arrangements
- Allow or restrict the selection of individual luminaires within an arrangement
- Allow or restrict the selection of rotatable luminaire parts
- Allow or restrict the selection of furniture
- Allow or restrict the selection of surfaces
- Allow or restrict the selection of windows, doors, calculation surfaces
- Allow or restrict the selection of calculation points

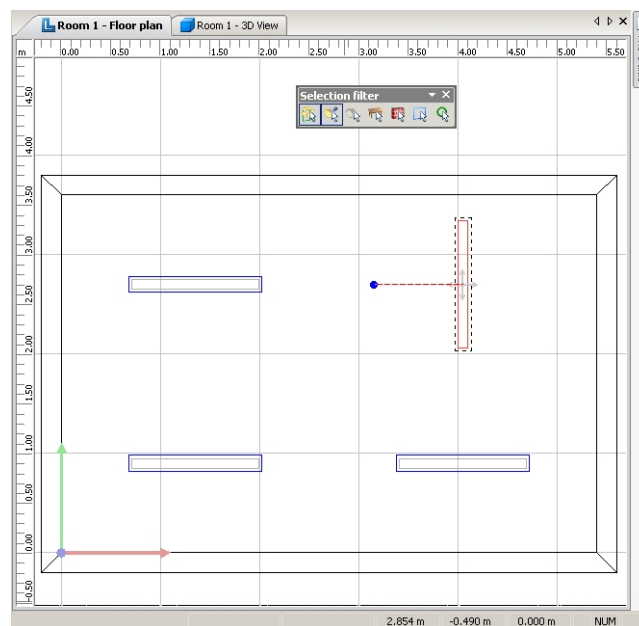

Fig. 151 Manipulating a luminaire within an arrangement

The figure above illustrates how individual luminaires within a field arrangement can be modified. The selection filter allows the selection of individual luminaires. The luminaire position is unchanged. This option, for example, can be useful when directing individual spotlights in a luminaire arrangement towards furniture pieces.

In the *Inspector* the luminaire properties can be changed. Here it is possible to select the arrangement type and the dimensioning type of luminaire fields.

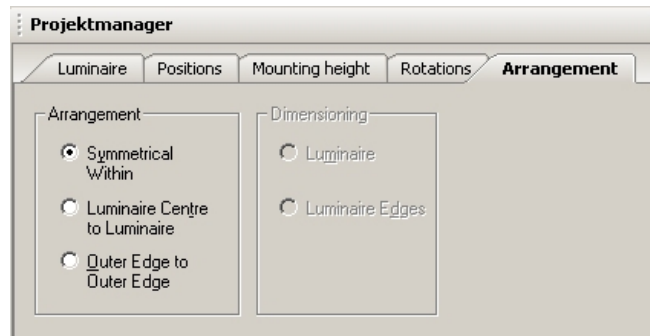

Fig. 152 Selecting the arrangement type of a luminaire field

The selected arrangement type, as well as the dimensioning, influences the field properties.

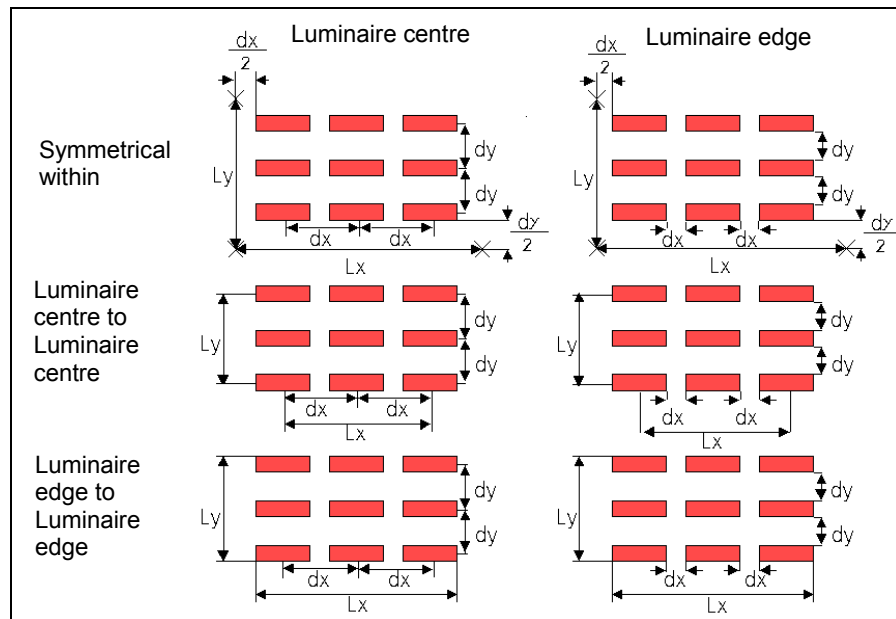

Fig. 153 Effect of arrangement type and dimensioning type on the luminaire field dimensions

The arrangement type is also taken into account when the luminaire fields are edited via CAD.

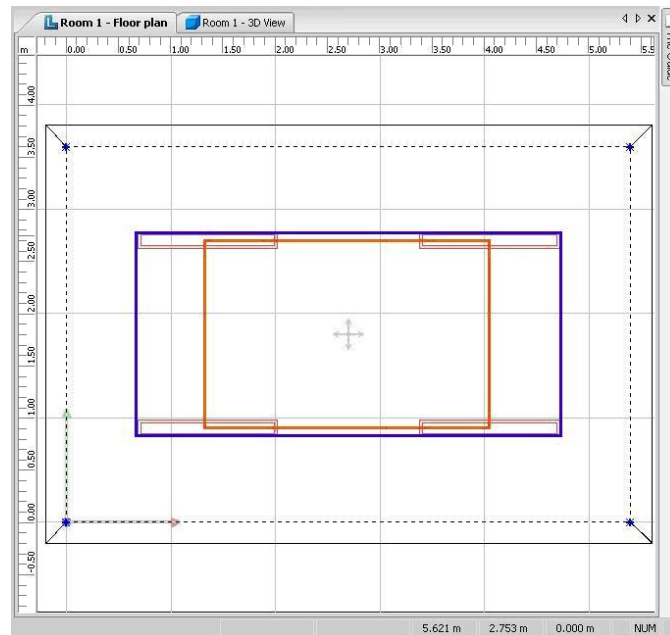

Fig. 154 Luminaire field insert frames depending on the arrangement type

In the CAD ground plan view, three possible edit or insert frames for the luminaire field are shown. When the *Symmetrical Within* arrangement type is selected, the outer blue broken line appears. The frame in the middle appears when *Outer Edge to Outer Edge* and the innermost red frame correspondingly appears with the *Luminaire Centre to Luminaire Centre* selection. The dimensioning of the luminaires and of the start and end point of the field correspondingly changes. You can change the extent of the luminaire field via the mouse. To do this, right-click on the field (in the tree or in the CAD). By pulling on a line or on a corner coordinate, you can change the extent, just like you can do with the furniture. Please note that the amount and, of course, the size of the luminaires remain the same.

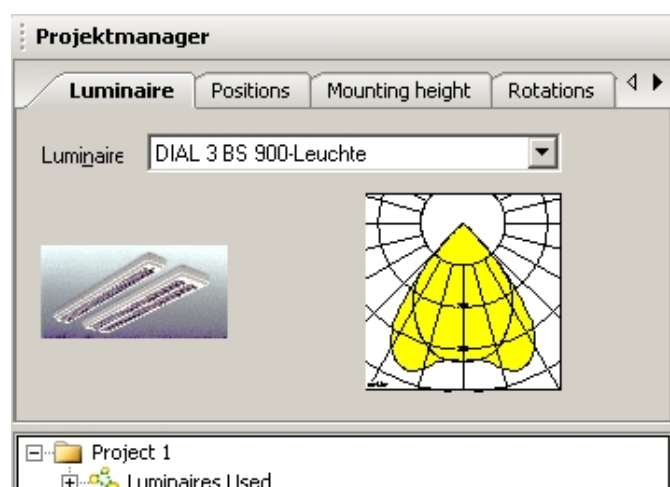

Fig. 155 Luminaires used in the arrangement

The luminaires in an arrangement can also be manipulated subsequently. As you can see in the

illustration above, the luminaires and the lamps used in the field can be modified without having to delete the field.

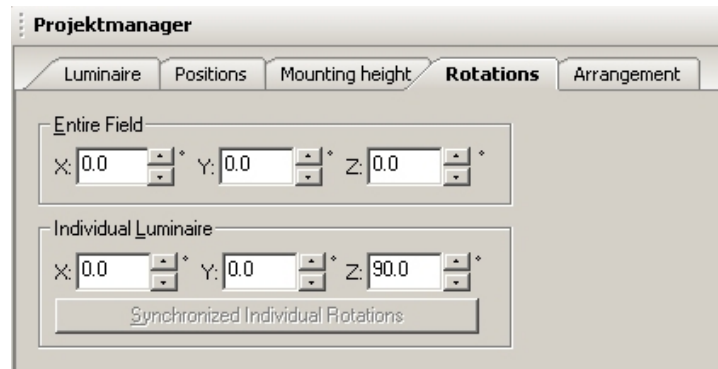

Fig. 156 Rotating the arrangement and the luminaires

Both the rotation of the entire field as well as the rotation of the luminaires within the field can be modified numerically or graphically. To rotate a single luminaire within a field, it must be selected individually. Additionally there is the possibility to synchronize individual rotations.

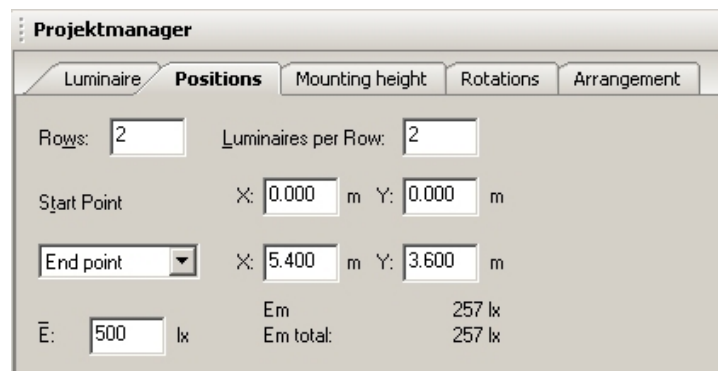

Fig. 157 Luminaire field position

The position of a luminaire field can also be modified numerically or graphically.

Inserting Luminaire Lines

Luminaire lines can also be positioned via the *Wizard* or manually. After a line has been inserted, the length, the position or the angle can be graphically modified.

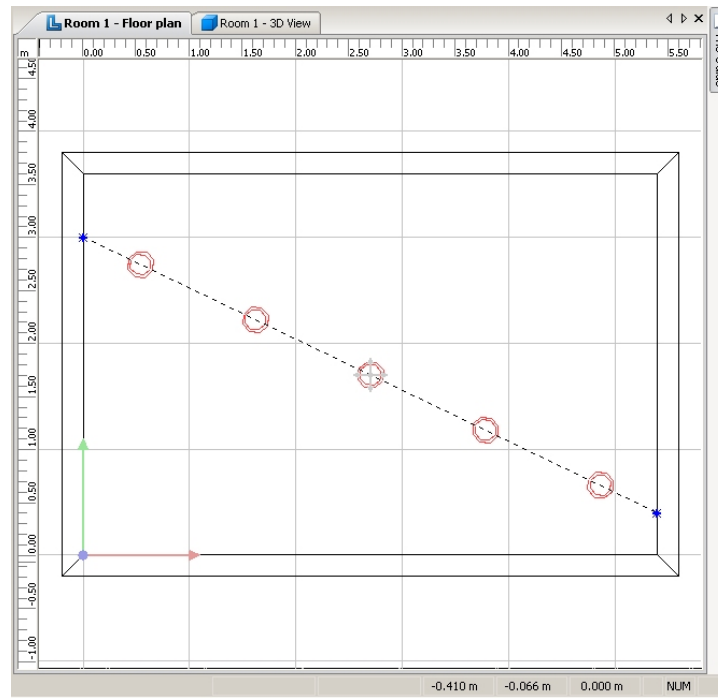

Fig. 158 Scale a luminaire line

If you pull the cross in the middle of the line with the mouse, you change the position. The angle and the length of the line remain constant. With the blue end points you can modify the length and the angle at the same time. It is not necessary to switch between *scale* mode and *rotate* mode.

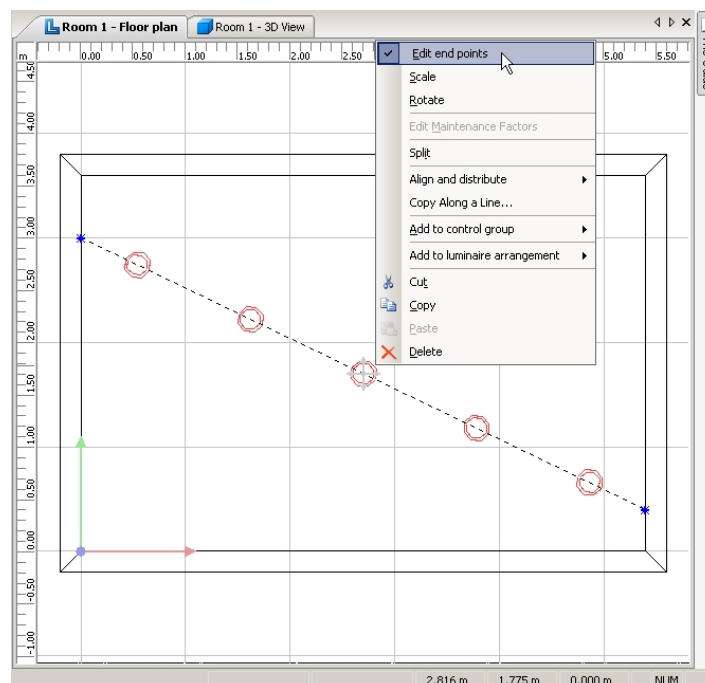
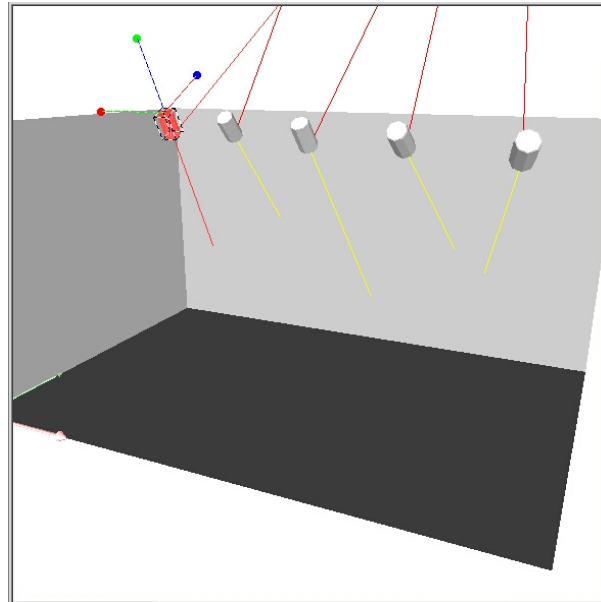

Fig. 159 Edit a luminaire line

If the luminaires within the arrangement have not been rotated, the CO of the luminaires is directed towards the row axis (from the start point in the direction of the end point).

Aligning Lights

If you select individual luminaires in an arrangement via CAD, you can also modify their rotation within the arrangement. The position of the luminaires remains constant. You may also use the function set *illumination point*.



Alignment of lights on a track.
Alignment of luminaires within an arrangement.



Use this option to switch on the luminaire help rays and the CO arrows. The help rays indicates $\text{Gamma}=0^\circ$.

Fig. 160 Aligning individual luminaires within an arrangement

To be able to select individual luminaires within an arrangement, the selection filter must be set accordingly.

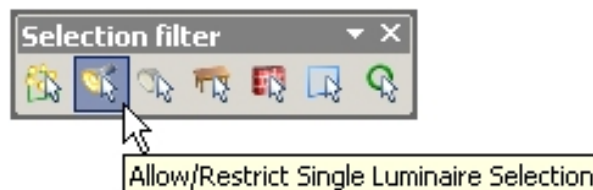

Fig. 161 Selection filter for CAD selection

The fourth icon from the right enables the selection of individual luminaires within an arrangement.

NOTE: A single luminaire is an *individual luminaire arrangement*.

Inserting Luminaire Circles

At the moment, no wizard for positioning luminaire circle arrangements is available. The options are very similar to those already described. Additionally we would like to point out the *Start Angle* and *End Angle* options.

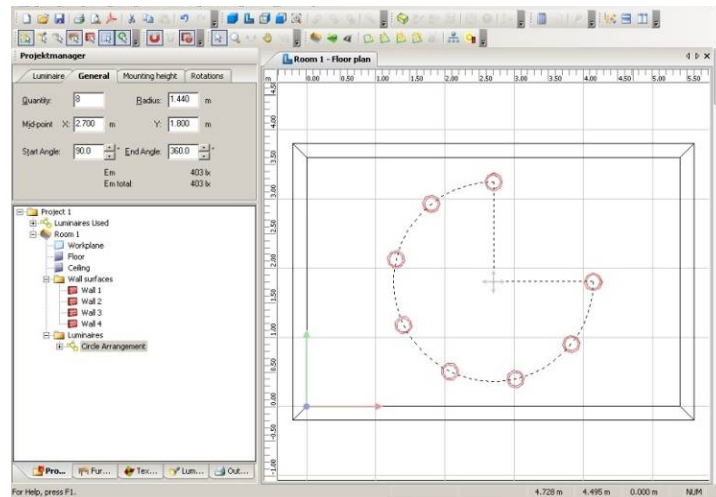

Fig. 162 Luminaire circle start and end angle

When the start angle is 0° , the first luminaire is positioned to the right of the mid-point at distance r on a straight line which is parallel to the X axis. Positive angles ($> 0^\circ$) are created counter clockwise. If the individual luminaires are not rotated, the C0 level of each luminaire radiates outward.

Separating Luminaire Arrangements

An inserted luminaire arrangement can be separated into individual luminaires by right-clicking on the arrangement and selecting split. Subsequently the position of the individual luminaires can be modified. You can also separate a selected arrangement into individual luminaires via the *Edit* → *Split Luminaire Arrangement* menu option.

Floodlighting

The new features in DIALux 4.9 for floodlighting are very suitable for uniform illumination of large areas, e.g. sports complexes. Floodlight illumination consists of an arrangement of one or more luminaires which are mounted separately on a pole or traverse. In DIALux you have the additional option of mirroring such a pole etc, either vertically, horizontally or a combination of the two and thus achieving uniform illumination of the whole area.

Inserting floodlight illumination

In order to insert a floodlight arrangement in DIALux, select via the menu "Paste" → "Luminaire Arrangement" → "Floodlight Arrangement". At the position of the origin of the scene, a luminaire is now placed in the bottom left hand corner. The default setting is that the floodlighting illumination is aligned to the origin of the ground element. You can make a pre-

selection of the luminaires to be used as well as their arrangement (quantity, mounting method and mirroring properties).

Please note:

A luminaire which is added to a floodlighting illumination must already be available in the project. If several luminaires are available in the project, you can simply select from these in the project manager for floodlight illumination.

After confirming with "Paste", the floodlight illumination is inserted into your sports complex.

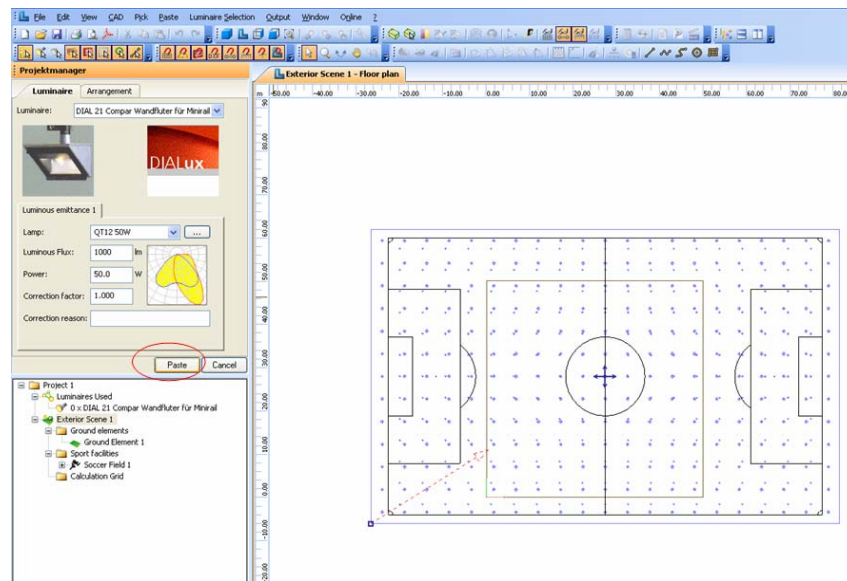

Fig. 163 Inserting floodlight illumination in a sports complex

You will find settings options in the Inspector of your floodlight illumination.



Fig. 164 Settings options in the project manager

Arranging floodlighting

As mentioned before, it is possible to make a selection for mirroring floodlighting (in the tab "Arrangement" in the project manager).

This can be done vertically, horizontally or by a combination of the two. In the latter case it improves illumination uniformity of the scene.

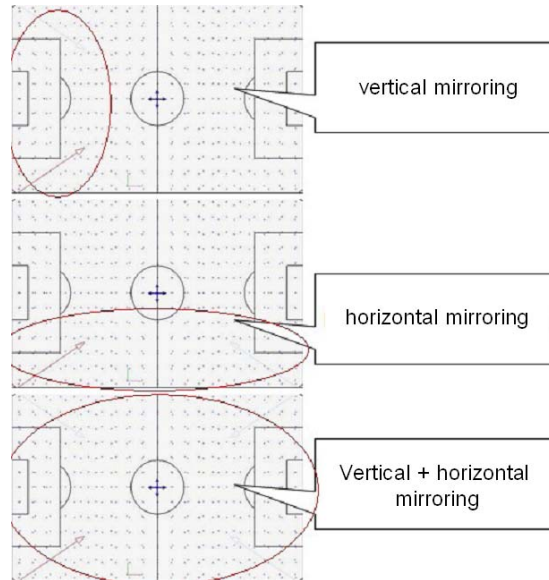

Fig. 165 Mirroring options for floodlight illumination

Under the tab "Arrangement" you can also determine the number of luminaires. This quantity is the same as the number of illumination points in "Illumination Points" tab of the floodlight arrangement.

Focal points

With the tab "Illumination Points" it is possible at this stage to add additional illumination points which results in a corresponding increase in the number of luminaires. According to the DIALux standard the illumination points of the luminaires are aligned to the position of origin of the sports complex; with the aid of the coordinates (x, y and z) they can be changed manually into absolute numbers or as an angle for each individual luminaire.

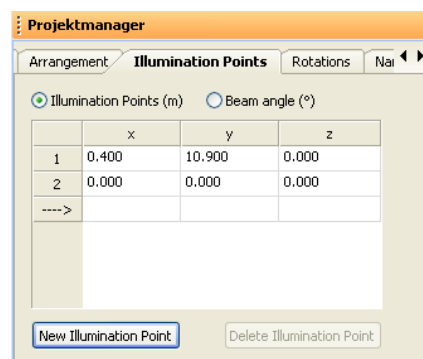

Fig. 166 Options for changing the illumination points

A further option for changing the illumination points is simply to slide the illumination point to another position. Just use the left mouse button to click on the illumination point and slide it to the desired position.

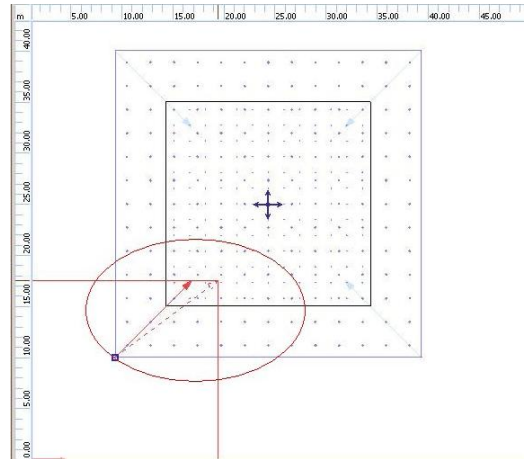

Fig. 167 Moving an illumination point manually

The alignment of each luminaire to its illumination point is displayed in the CAD window as a blue arrow. The red arrow(s) belong to the original luminaire(s) which is (are) mirrored in the project.

Symmetrical mirroring helps to save time when positioning the luminaires. If, in specific positions, you need different or more luminaires or even different illumination points you have the option to insert a further floodlighting illumination in addition to the existing one. Alternatively you can cancel the existing floodlight illumination. With the right mouse button simply select the item "Cancel Symmetry" in the context menu.

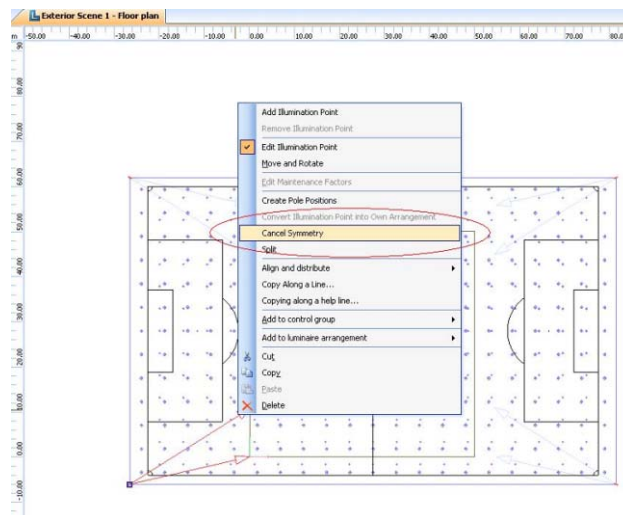

Fig. 168 Cancelling the symmetry of floodlight illumination

An arrangement of individually adjustable luminaire positions now results from the mirrored arrangement.

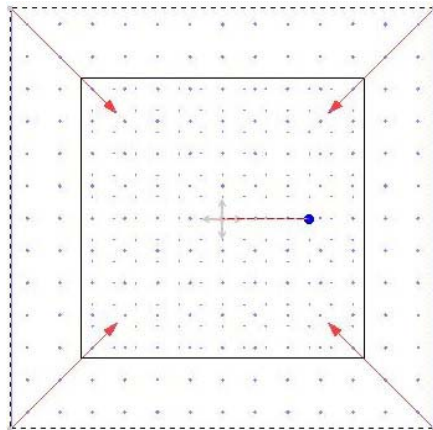

Fig. 169 Individually adjustable luminaire positions after cancelling the symmetry

If you do not wish to change one particular luminaire position only, then it is best to remove this luminaire from the luminaire arrangement. You can do this by clicking with the right mouse button on the respective luminaire and then selecting “change illumination point into an individual arrangement” in the context menu. When you do this, the symmetry of the luminaire arrangement remains.

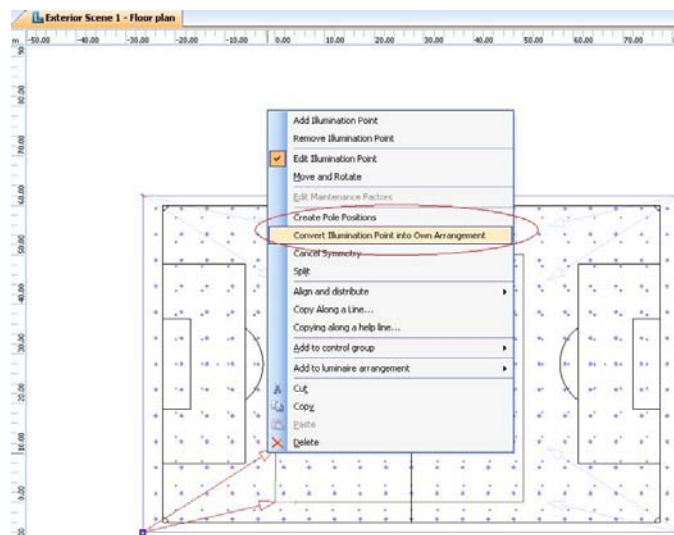

Fig. 170 Transforming a single luminaire into an individual arrangement.

Modify the position of a Luminaire

To modify the position of a luminaire you can select the luminaire in the *Project manager*. Now you can use the Property Page with the coordinate fields.

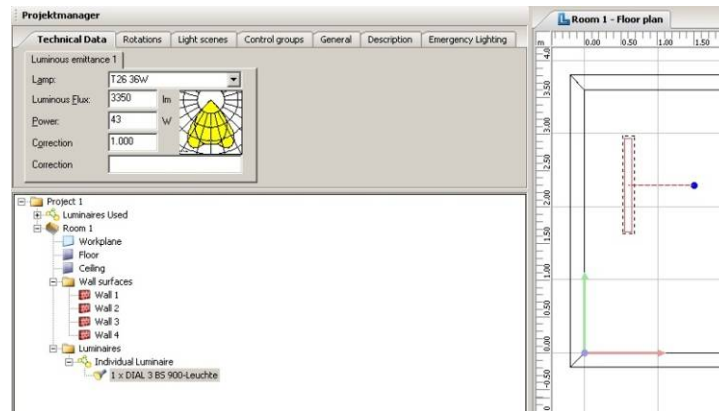

Fig. 171 Modify luminaire data – Corrections

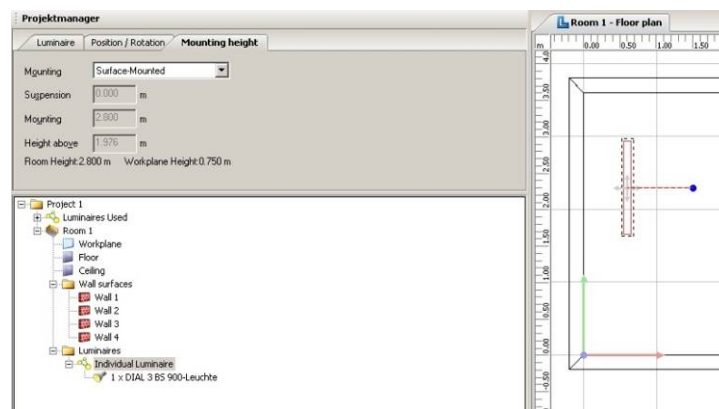

Fig. 172 Modify luminaire data – Mounting height

Luminaires with articulated joints

With DIALux it is possible in computer-aided lighting design to make use of all the mechanical properties of luminaires. In DIALux with 3D luminaire models it is possible, as in real life, to grasp the articulated joints and adjust them (spots, fully suspended systems, floodlights, street lighting). The manufacturer defines the articulated joints, the maximum rotation and even the increments of articulation. You simply click on the luminaire and turn it to where the light should be directed. Of course you can do this numerically or graphically.



Fig. 173 Selection of rotatable luminaire parts

The third icon from left allows the selection of rotatable luminaire parts. If you have activated this icon, you can turn the luminaire with articulated joint to the desired position or you can specify the rotations in the appropriate Property Page.

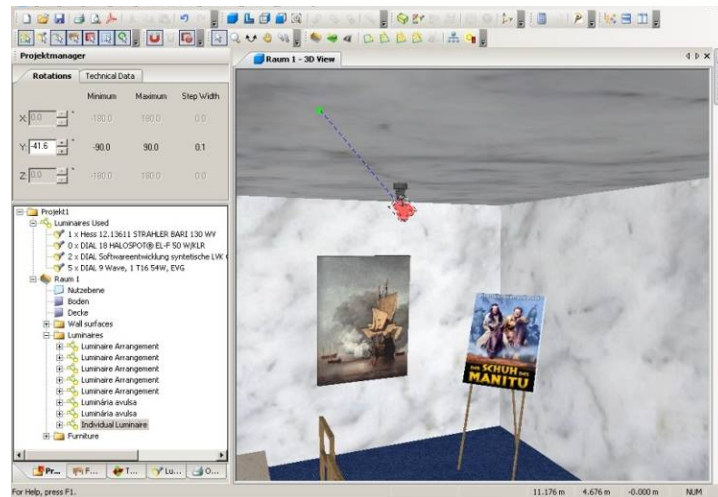

Fig. 174 Turn the rotatable luminaire part by mouse pointer

You can also align the luminaire with articulated joint to CO-G0, C90-G0 or Imax. (see similar chapter Aligning Luminaires).

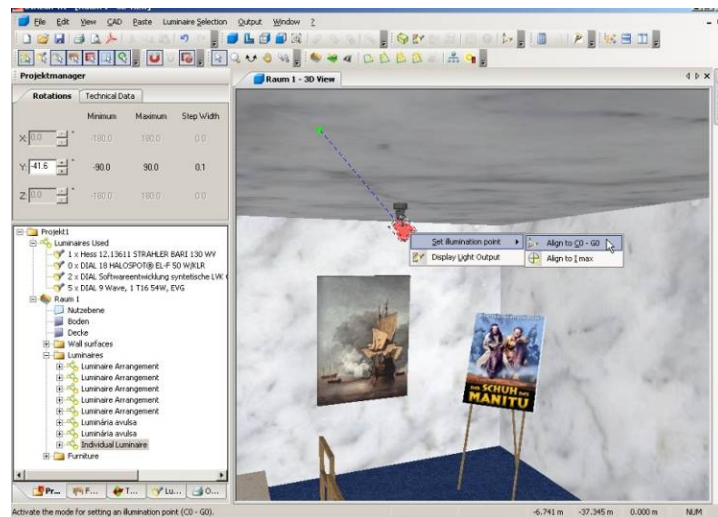

Fig. 175 Align the rotatable luminaire part

Luminaires with several articulated joints

In DIALux 4.9 luminaires can have several rotatable elements. Luminaires with one or more articulated joints, and therefore with one or more luminaire elements, can be shown separately in the project tree with their own symbol.



Fig. 176 Symbol for luminaires with several articulated joints

Unrestricted lighting arrangements

With DIALux you can position the luminaires individually, in a circle, in a line or in a field. You can then form them into groups to deal with them geometrically and/or as an electrical unit. Just add your desired luminaire

arrangement to a new luminaire arrangement via the context menu of the selected luminaire arrangement.

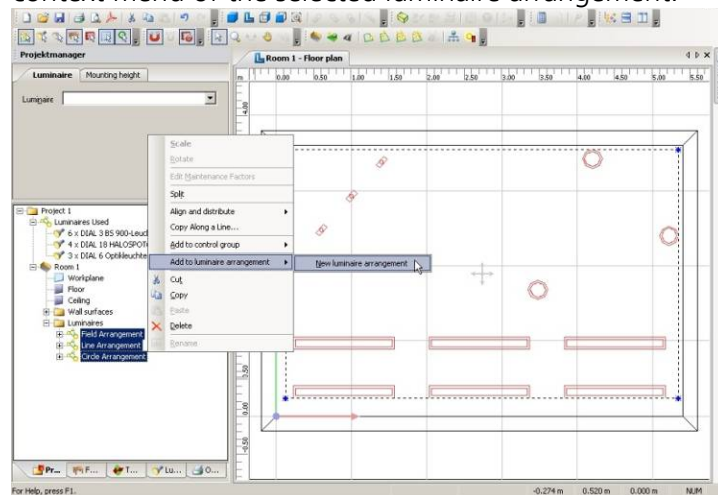

Fig. 177 Context menu of the unrestricted luminaire arrangement

You can modify these further by changing the name, position / rotate or modify the origin.

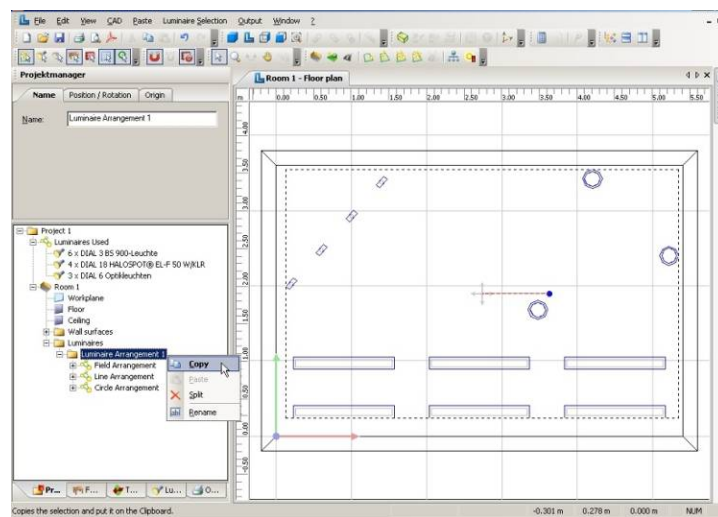

Fig. 178 Modify the new luminaire arrangement

You have the ability to copy and paste the whole luminaire arrangement in the context menu. If you want to take out individual luminaires of the new luminaire group, first of all you have to split the unrestricted luminaire arrangement. Then you can select the luminaire which should be removed from luminaire group and open the context menu. Now you can access the function *Remove from luminaire group*.

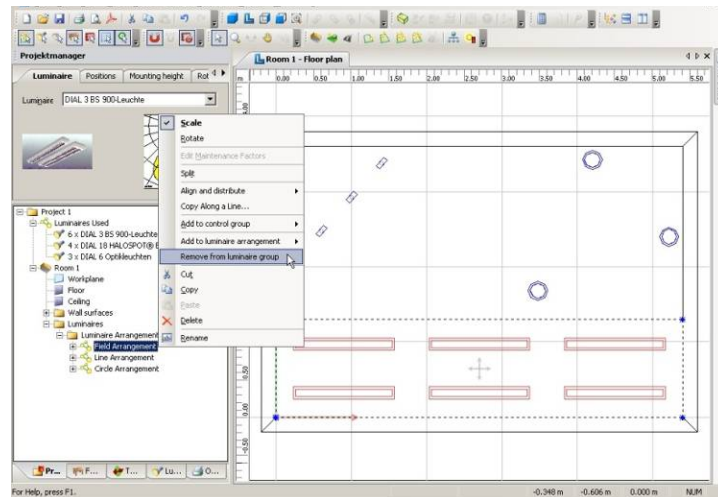

Fig. 179 Remove from luminaire group

Aligning luminaire arrangements

You can align to C0-G0, C90-G0 or I_{max} among individual luminaires as well as complete luminaire arrangements. To do this select the inserted luminaire arrangement (luminaire field, line or circle arrangement, unrestricted luminaire arrangement) and select Rotate with the context menu.

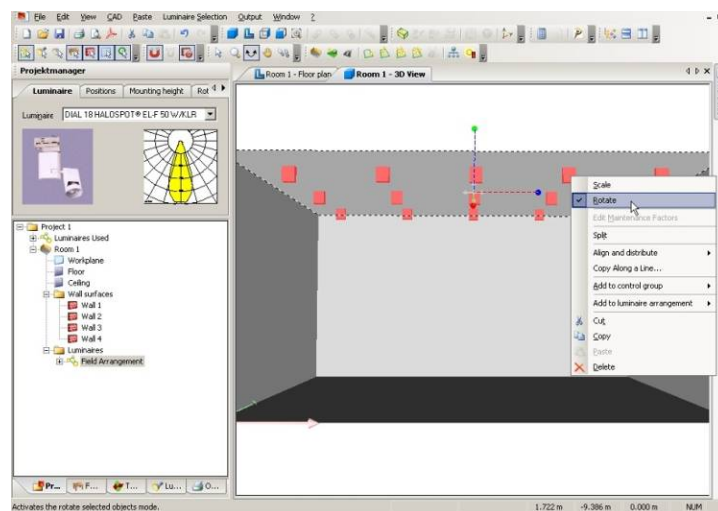

Fig. 180 Aligning luminaire arrangements – Context menu

Then the function *Set illumination point (to C0-G0 or C90-G0 or I_{max})* is activated and you can align the luminaire arrangements (see also chapter Aligning Luminaires).

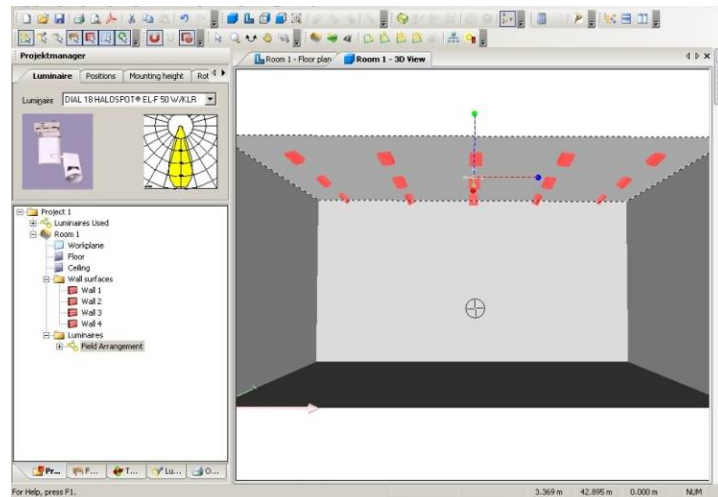

Fig. 181 Set illumination point – Aligned luminaire field

Calculation of luminaire geometry included

On request the user can now include luminaire geometry in the calculation. This is not necessary with normal surface-mounted or recessed luminaires. Extended pendant luminaires which emit light directly or indirectly may hang in their own shadow, perhaps making it necessary to consider the luminaire geometry.

Illumination strategies

Insertion of luminaires with “direct planar lighting”

To use direct lighting solutions one or more luminaires should be selected from the DIALux database initially. Afterwards the selected luminaires should be added to a DIALux project. By clicking the button “direct planar lighting” in the DIALux toolbar it is possible to insert a new direct planar lighting solution.

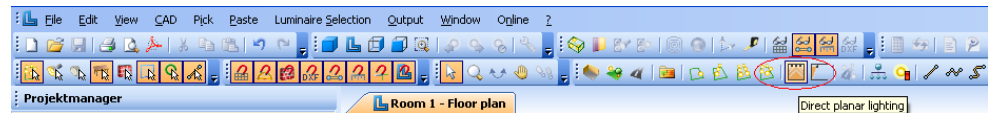

Fig. 182 Selection of a direct planar lighting situation

Another way to insert a direct planar lighting situation is through the selection of “Paste → Luminaire Arrangement” in the DIALux Menu.

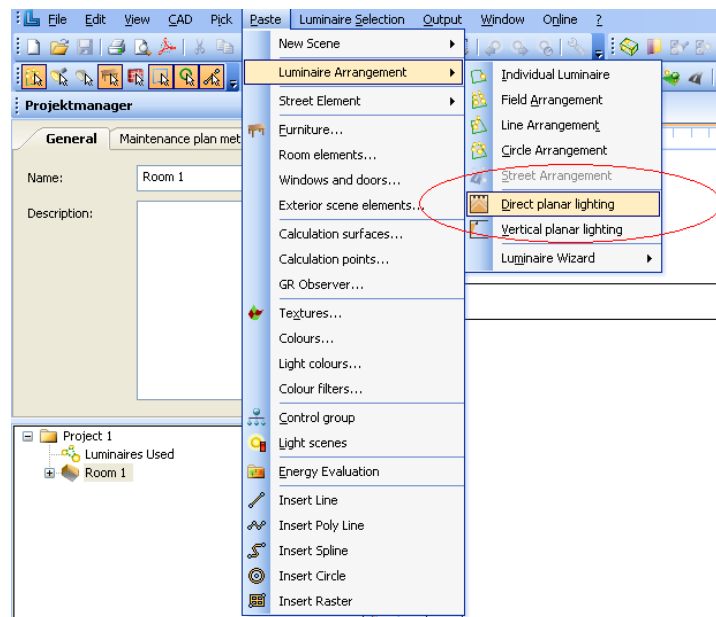

Fig. 183 Alternative solution to insert a direct planar lighting situation

After inserting a room, click the left mouse button in the CAD window and drag the mouse to generate a rectangle in your actual room. This rectangle represents the direct surface which should be illuminated. By clicking “Paste” in the project manager on the left all selected luminaires are inserted into the project respectively into the room giving uniform illumination.

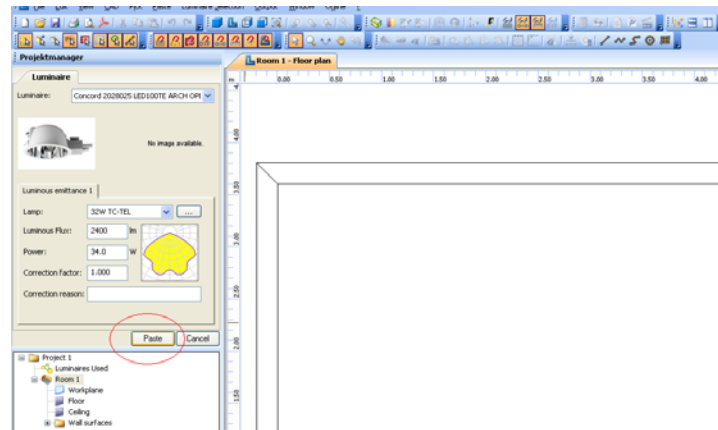

Fig. 184 Insertion of selected luminaires into the direct planar lighting situation

The geometry of the direct planar lighting can be modified arbitrarily. Therefore choose a point on the selected rectangle and shift it to the preferred position. While clicking the right mouse button within the geometry additional points can be inserted.

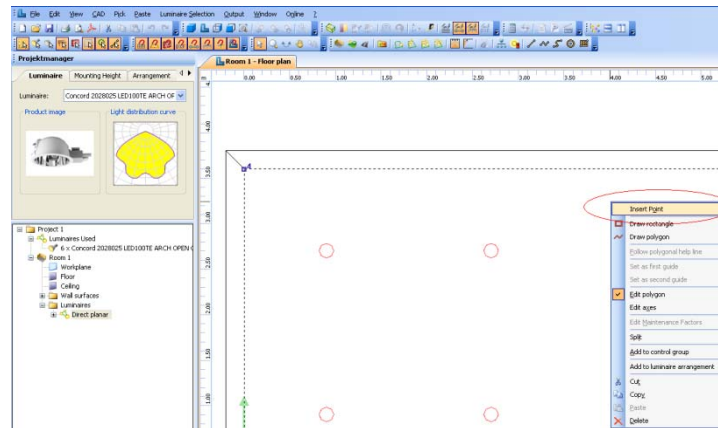

Fig. 185 Insertion of additional points to the lighting situation

The project manager provides you with several possibilities to modify settings individually. Amongst others you are able to make changes in Mounting Height (Fig. 186.1), Arrangement of luminaires (Fig. 186.2) and Rotation of single luminaires (Fig. 186.3).

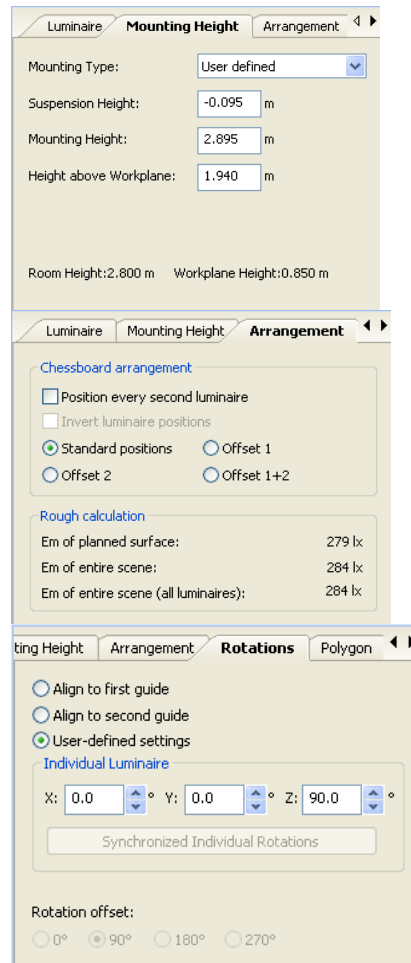

Fig. 186 Changes in Mounting Height (1), Arrangement of luminaires (2) and Rotations of single luminaires (3) at vertical planar lighting solutions

For editing the two different axes within the geometry simply click the right mouse button and select Edit axes. The blue and red dotted lines represent the two axes. On these axes the luminaires are arranged. By clicking the left mouse button and moving the mouse simultaneously the axes can be positioned.

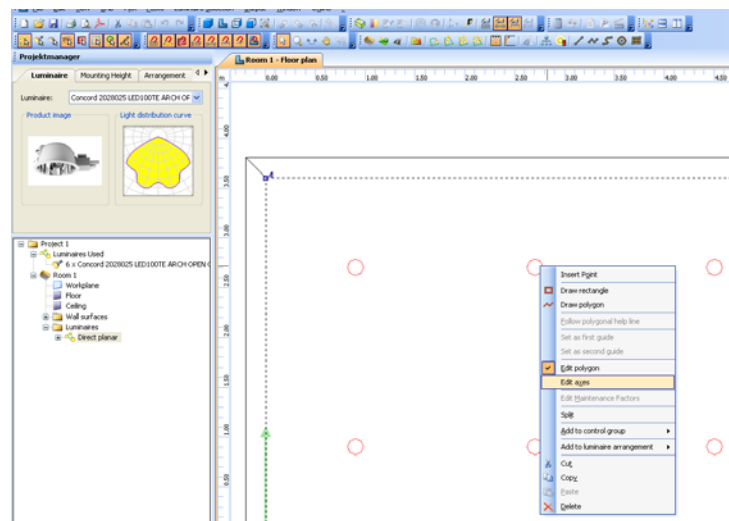

Fig. 187 Editing the single axes – direct planar lighting

Insertion of luminaires with “vertical planar lighting”

The procedure to insert a vertical planar lighting solution is the same as with direct planar lighting. Firstly one or more luminaires should be selected from the DIALux database. Secondly these luminaires should be added to the actual project. By clicking the button “vertical planar lighting” in the DIALux toolbar you are able to create a vertical planar lighting solution.

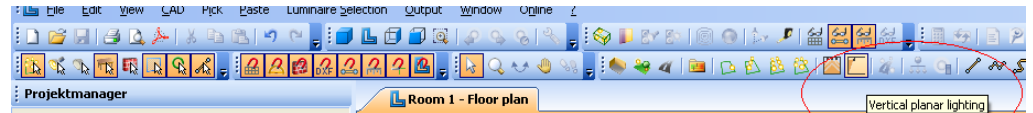

Fig. 188 Selection of a vertical planar lighting situation

Alternatively you can insert a vertical planar lighting situation as well through “Paste → Luminaire Arrangement” in the DIALux Menu.

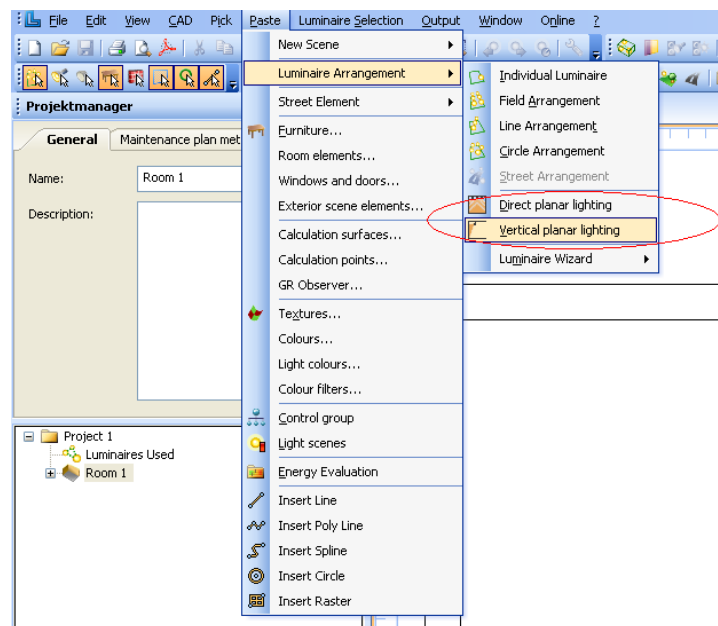

Fig. 189 Alternative solution to insert a vertical planar lighting situation

After clicking the button a project window opens. You are now able to draw a line which represents the arrangement of the selected luminaires. By clicking the left mouse button and dragging a help line is drawn. By default every 1 metre a luminaire will be positioned. The button “Paste” on the left side will execute the insertion of the selected luminaires.

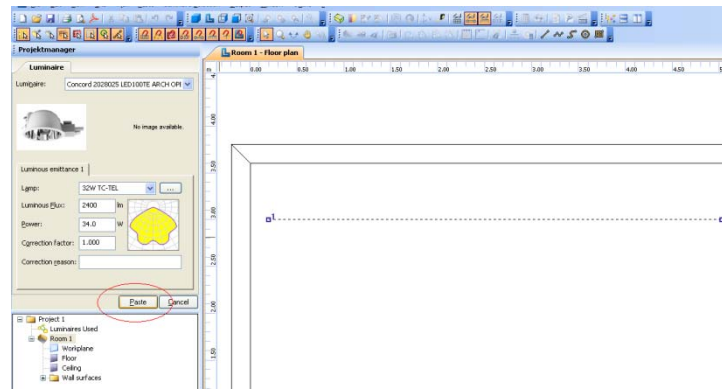

Fig. 190 Insertion of selected luminaires into the vertical planar lighting solution

As well as direct planar lighting solutions the project manager provides you with several possibilities to modify settings individually. Amongst others you are able to make changes in Mounting Height (Figure 182.1), Arrangement of luminaires (Figure 182.2) and Rotation of single luminaires (Figure 182.3).

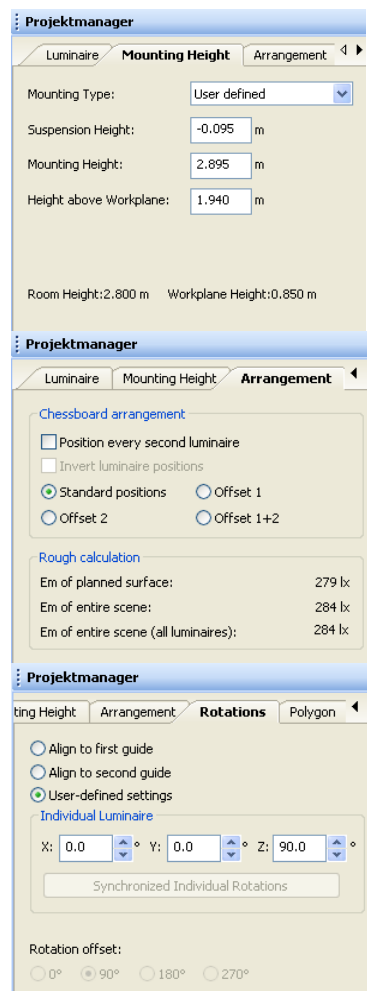

Fig. 191 Changes in Mounting Height (1), Arrangement of luminaires (2) and Rotations of single luminaires (3) at vertical planar lighting solutions

By clicking the right mouse button on a luminaire within the actual room you are able to adjust the axes by selecting Edit axes. The axes are blue and red dotted. The

luminaries are positioned on these axes. To shift the two different axes simply click left directly onto the axis and drag the mouse.

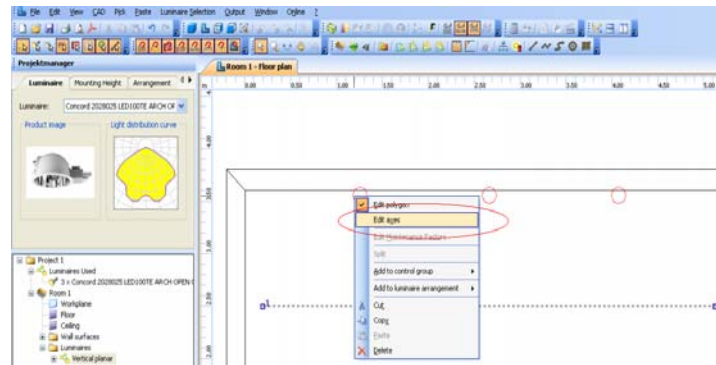

Fig. 192 Editing the single axes – vertical planar lighting

Coloured light

Background information

Up to now DIALux only calculated “white” light. The amount of “light energy” distributed by the luminaire was defined by the luminous flux of the lamp(s) and the light output ratio of the luminaire. The spectral distribution, the wavelengths of the distributed radiation was not taken into account. This approach is usually correct, because interior and exterior lighting design is mainly made with “white” light sources. Calculated values are totally correct, as long as only direct light is taken into account (without reflection). When reflected light has to be considered, the mistake made in the calculation can be serious. This depends on the spectral reflection of the material and the spectral distribution of the light sources.

Technical data of luminaires mainly describe the distribution of the light. Well known examples are the DIALux internal ULD format, CIBSE TM14, EULUMDAT, IES and others. The data describes the intensity of light from the light centre of the luminaire in defined directions. Unfortunately there is no information about the spectral distribution of the light from the light source given. Typically text informs the user which lamp is used e.g. T5 / 49W 830. The expert knows, that this is a triphosphor fluorescent lamp with a correlated colour temperature of 3000K and a colour rendering index greater than 80. The colour of light is now more or less described but not for a correct calculation. If light is to be calculated correctly including the colour information, it is absolutely necessary to know the spectral distribution.

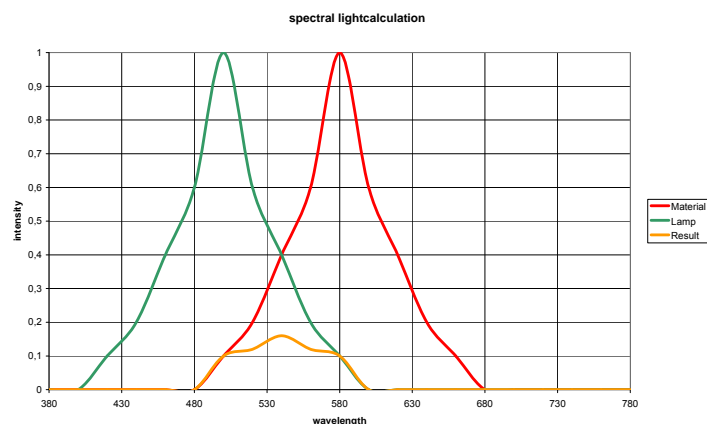

Fig. 193 Spectral light calculation

In this diagram you can see the spectral distribution of the light source (green) and the spectral reflection factor of a material (red) in the visible spectrum. The reflected light from this surface would have the spectral distribution as shown by the orange line. Up to now, this

effect was not taken into account by the calculation. For the light source the radiation was constant over the visible spectrum. The amount was defined by the luminous flux. For the material also the reflection factor was taken as constant over the visible spectrum.

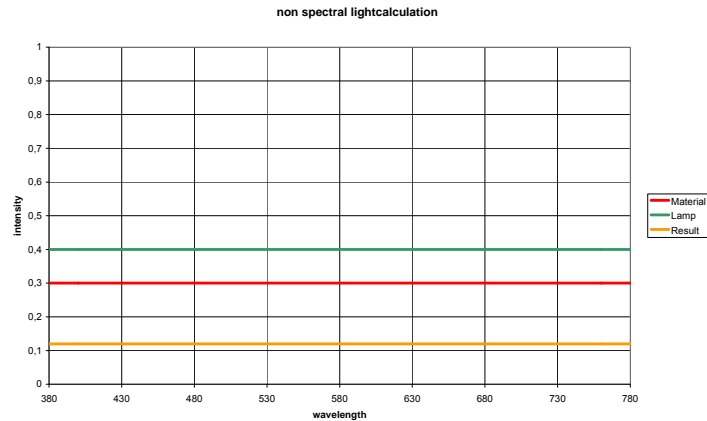

Fig. 194 Non spectral light calculation

That this effect leads to serious errors calculating coloured light or coloured material is obvious.

DIALux can now take into account the spectra of light sources, the spectra of colour filters and materials. The luminous flux of the lamp is now distributed to the individual wavelengths according to the data given in the spectral distribution. Because of this the results are more accurate and the visualisation is improved. Now all colour effects can be displayed in the rendering.

Lamp spectrum / Light colours

Lamps can have a spectrum already defined in the luminaire PlugIn or in the lamp PlugIn. In that case, the user does not have to do any additional spectra selection to take colour into account in the light calculation. Some luminaire manufacturers offer their own luminaire catalogue in combination with filter and lamp spectra.

In the colour tree of DIALux you can see the subfolder Textures, Colours, Light colours and Colour filter. While textures and colours are only for use with objects (room surfaces, furniture,...) the light colours and colour filters are for use with luminaires. The difference between light colour and colour filter is very important.

The light colour is the result of the spectral distribution of the luminous flux of the lamp. In the folder light colour there are three subfolders with specific spectral distributions for the black-body radiator, for standard spectra and for common lamps. The common lamps are again divided into the incandescent lamps, fluorescent lamps and high pressure discharge lamps.

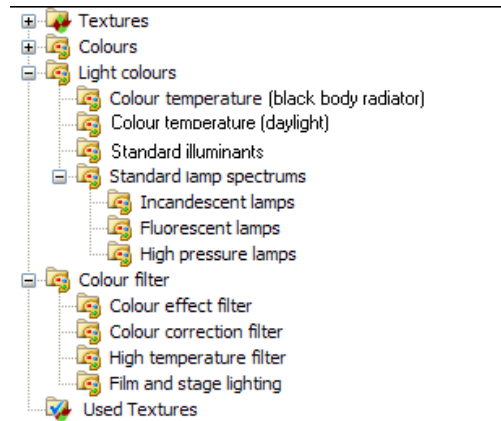

Fig. 195 Light colours in the DIALux colour tree

These spectra can be used for a lighting calculation. They can easily be dropped onto a luminaire. If a spectrum is selected, the inspector shows information regarding the correlated colour temperature, the spectral distribution and the colour rendering index.

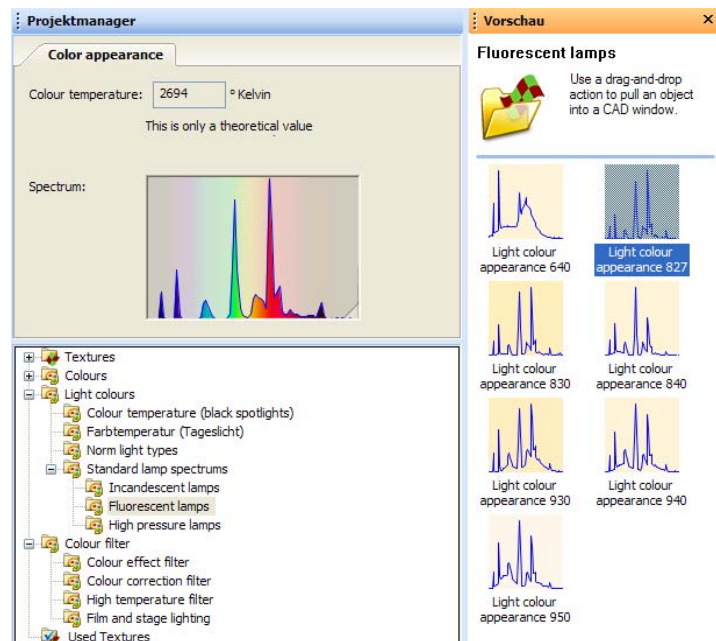

Fig. 196 Colour information for a selected spectrum

Selecting a spectrum in the colour tree, the inspector shows a graphical preview of the spectral distribution and a value for the correlating colour temperature. This value is only exact for a thermal radiator. The colour appearance of this spectrum is displayed as the background colour of the spectrum itself on the right hand side. A click on the lower right corner of the diagram in the inspector shows a preview of the CIE test colour samples illuminated with the spectral radiation of this light source. For each colour sample the colour rendering index is given and the Ra is also calculated.

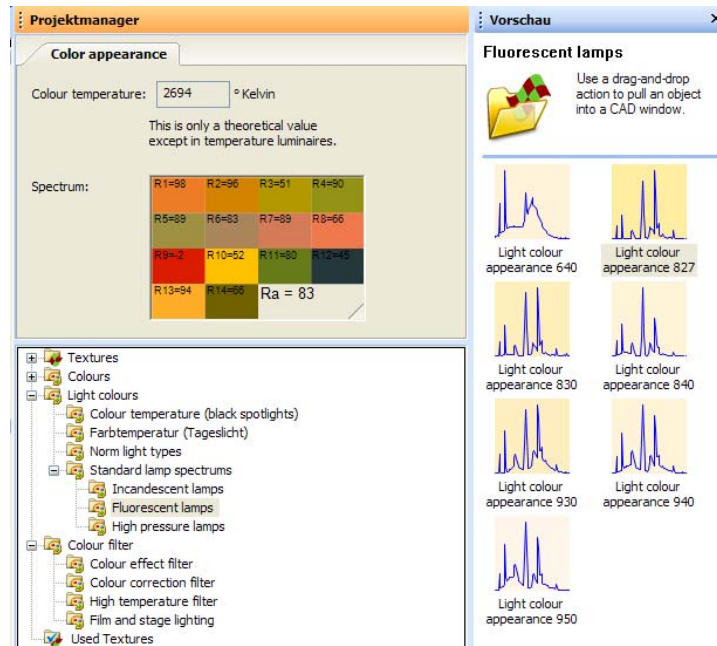

Fig. 197 Colour rendering indices of the CIE test colours (CIE 13.3)

The display is to specify the colour rendering and colour matching properties of light sources.

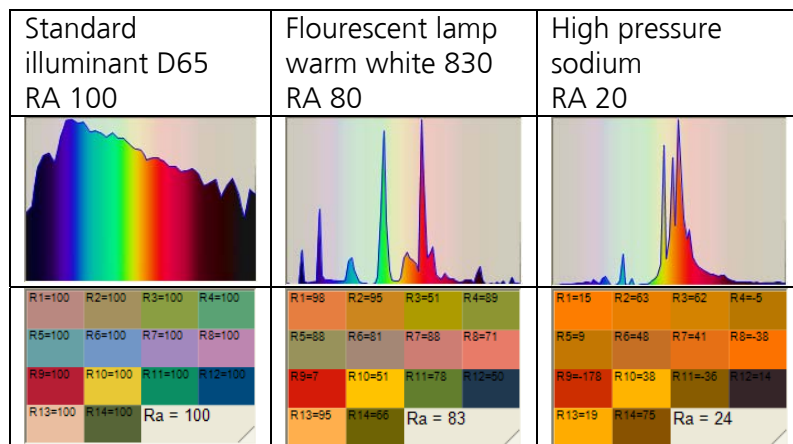

Fig. 198 Spectra and colour rendering properties of different light sources

The colour rendering index (CRI) (sometimes called Colour Rendition Index), is a measure of the ability of a light source to reproduce the colours of various objects being lit by the source. It is a method devised by the International Commission on Illumination (CIE). The best possible rendition of colours is specified by a CRI of one hundred, while the very poorest rendition is specified by a CRI of zero. The CRI is measured by comparing the colour rendering of the test source to that of a "perfect" source which is generally a black body radiator, except for sources with colour temperatures above 5000K, in which case a simulated daylight (e.g. D65) is used.

To add a spectrum to a luminaire, just drag and drop it onto it. All luminaires within the arrangement (field, line,

circle or single) get that spectrum. To add a spectrum just to a single luminaire within the arrangement, just hold down the SHIFT key while dragging and dropping it. The luminaires show the replacement of a spectrum with blinking for a short time and the light emitting surface will appear in the colour of the light source (if available including the colour filter). If you want to put a spectrum to all luminaires in the room or exterior scene, just hold down the CTRL key while you drop it on any luminaire.

Luminaires with rotatable elements can get a spectrum and filter for each light emitting object individually.

If you just drag and drop a filter onto a luminaire with adjustable elements, all the luminaires of the same arrangement and all light outputs will get the spectrum / filter.

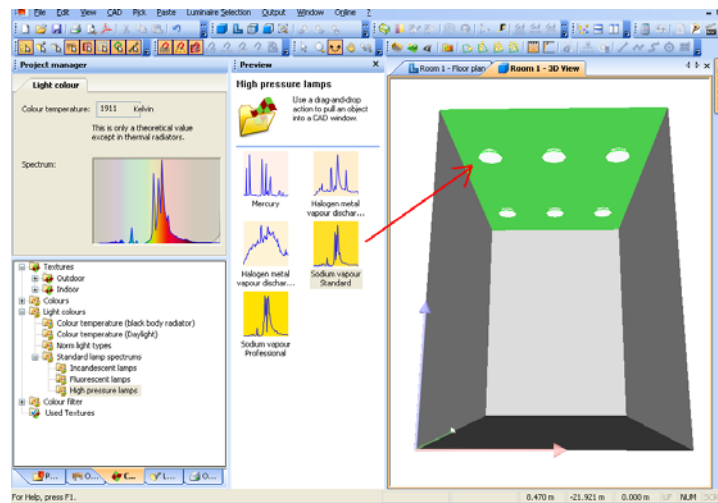

Fig. 199 Drag and Drop of a spectrum onto a luminaire with rotatable elements

The filter is not used on the luminaire of the same type which is in a single luminaire arrangement (in the middle) neither on the luminaire of a different type.

If you hold down the CTRL key while drag and drop the filter / spectrum, all luminaires and all light emitting elements get the spectrum. This includes those of a different type and in another arrangement.

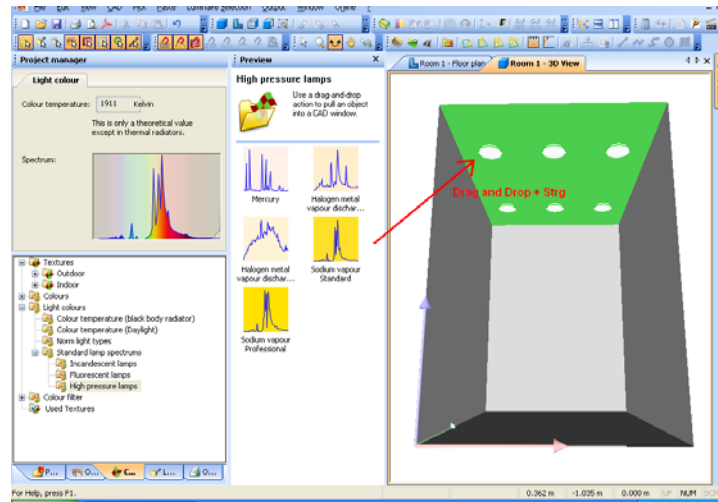

Fig. 200 Drag and drop of a filter / spectrum, while holding down the control key

IMPORTANT: Holding down the SHIFT key, makes only that light emitting element getting the filter that is picked by the mouse.

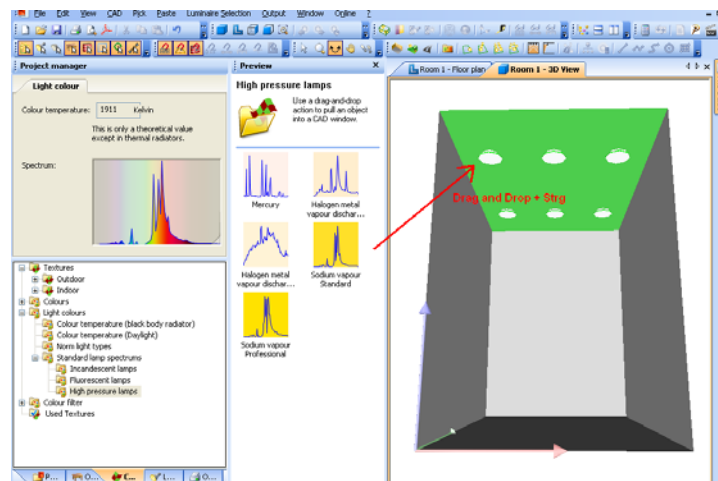

Fig. 201 Drag and drop of a spectrum / filter on a rotatable element of a luminaire while holding down the shift key

After a spectrum is added to a luminaire the Property Page "Colour appearance" tab displays the lamp spectrum, the filter spectrum and the resulting colour data. In the line "lamp colour" the name of the lamp spectrum is shown.

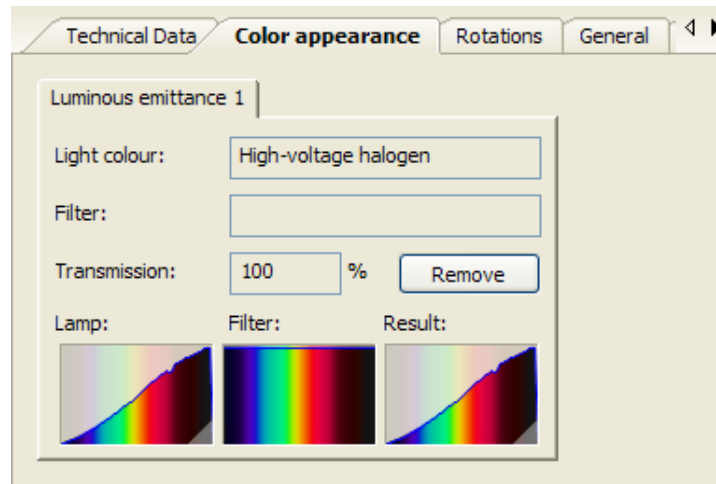

Fig. 202 Spectrum of the lamp, the filter and the resulting radiation. Click on the triangle on the bottom right to get the Ra values.

Colour filters

An optical filter is a device which selectively transmits light (often a particular range of wavelengths, representing a range of colours of light), while blocking the remainder. A filter can only block the specific unwanted range of wavelengths. The colour that the user wants to use has to be part of the spectral radiation of the light source. For example there is only a small amount of blue light in the spectral distribution of incandescent lamps. To get a high saturation of blue light another light source would be better.

In DIALux there are several hundred colour filters available. These are clear filters which had their spectral radiation measured in the photometric laboratory of DIAL. According to the usage of these filters they are stored in subfolders in the DIALux colour tree. The numbering is according to the numbering of the available product. In the preview you can see the colour appearance and the transmission factor when used with standard illuminant D65.

To add a light colour to just one luminaire in a scene, hold down the Shift key while drag and drop

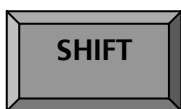

To add a light colour to all luminaires in a scene, hold down the CTRL key while drag and drop

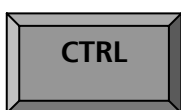

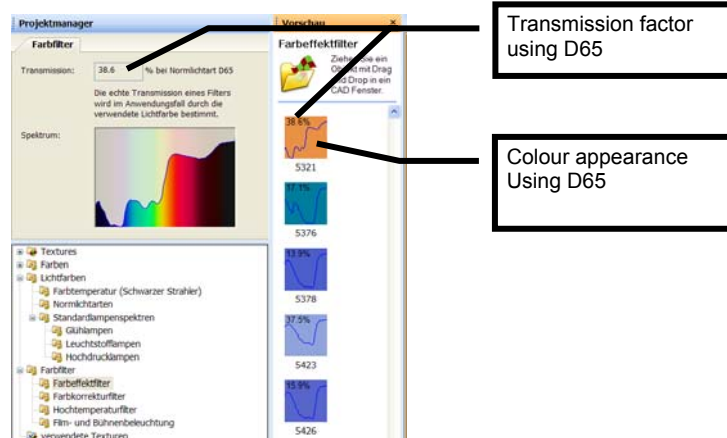

Fig. 203 Technical information of colour filter

To add a filter to a luminaire, just drag and drop it onto it. All luminaires within the arrangement (field, line, circle or single) get that filter. To add a filter just to a single luminaire within the arrangement, just hold down the SHIFT key while dragging and dropping it. The luminaires show the replacement of a filter with blinking for a short time and the light emitting surface will appear in the colour of the filter (if available including the colour of the light source). If you want to use a filter with all luminaires in the room or exterior scene, just hold down the CTRL key while you drop it on any luminaire.

Luminaires with rotatable elements can have a filter with each light emitting object individually.

Coaction of spectral distribution of the light source and colour filter

Most lighting calculation software has for each light source only one spectrum or even just a RGB value. But this is not enough for a professional lighting designer. The resulting colour is defined by the spectrum of the light source and the transmission spectrum of the filter.

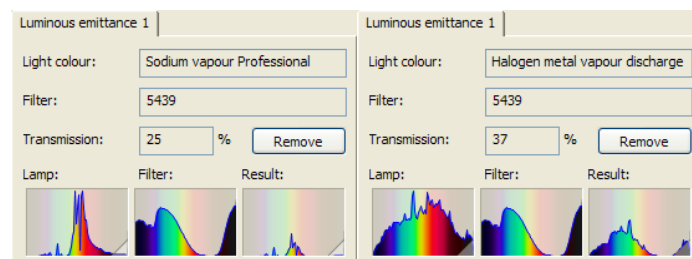

Fig. 204 Resulting spectrum of a luminaire with two times the same filter but different light sources

The two pictures above are from the Property Pages of two luminaires. In both cases the same colour filter was used. However the light sources are different, one is a high pressure sodium lamp and the other is a metal halide lamp. Of course the resulting spectrum is totally different. Also the transmission factor is different. The

transmission factor given for the filter at D65 is even higher at 41.6%.

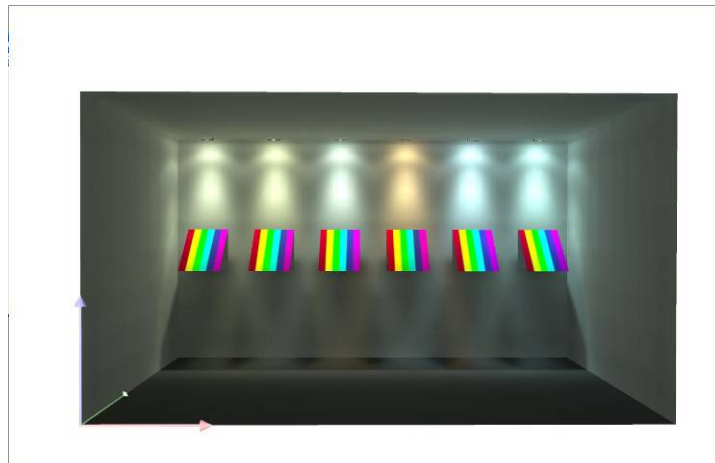

Fig. 205 All the spots are using the same colour filter, but have different light sources. From the left: Incandescent, Fluorescent 830, D65, high pressure sodium, metal halide ceramic and metal halide quartz

To get rid of a filter you can either click on the "Remove" button in the colour appearance Property Page or you drag and drop a "no filter" filter onto the luminaire. No filter is always in the top of the filter subfolders.

Light colours in the ray tracing

The used light colours and colour filters are automatically handed over to PovRay. There is no further setting necessary to use colours in the ray tracing visualisation.

White balance

The white balance is used to adjust the rendering on the monitor to the colour temperature of the lights in the scene. Digital and analogue recording of videos and pictures offer the option to use white balance to "correct" pictures. This imitates the ability of the human eye for chromatic adaptation.



Fig. 206 Four identical photos using different values for the white balance (Source: wikipedia, foto Thomas Steiner)

In the menu view you can select “Set white balance”. Selecting this function, you can choose different settings for using the white balance. Please keep in mind, that also your monitor has a setting for a white balance or at least for a colour temperature. These settings can counteract the software settings.

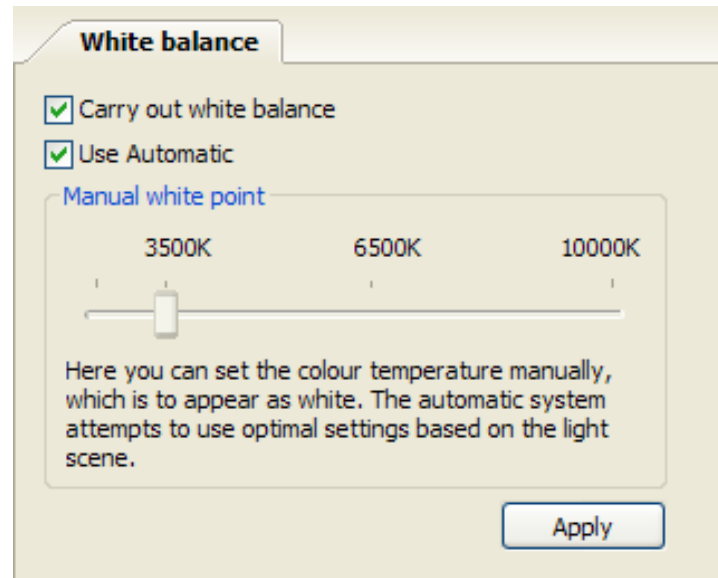

Fig. 207 Adjusting the white balance

Deselecting the checkbox “Carry out white balance” can make your rendering appear unrealistic and give a colour cast. We suggest using the automatic mode. If manual correction is necessary, switch of the automatic mode and adjust the slider to the colour temperature of the light in the rendering.

Light Scenes and Control Groups

Definition

DIALux supports the planning of dynamic light controls, e.g., on the base of DALI. There is the possibility to define luminaire groups, switch and dimming levels, to calculate light scenes, to visualize and to process the planning results for easy implementation. Light scenes define the changeable qualities of the contained control groups, as for example dimming levels, light colour, inclining and panning the luminaire and LDC. In light scenes groups of luminaire arrangements are called "control groups".

Requirements

Any luminaires can be added to control groups and also an individual luminaire can be included within an arrangement. Luminaires can exist in more than one control group. Light scenes can contain one or several control groups. Control groups cannot exist at the same time in the light scenes which contain the same luminaire. The complete light scene can be calculated as a whole or all necessary control groups of a light scene are calculated and the result can be changed afterwards interactively by changes in the light scene.

Generate a project with light scenes and control groups

Insert a new room and adapt all settings in the accompanying Property Pages (see chapter Edit Room Data). Subsequent you can insert the luminaires which you would like to use in your project. Select those which you want to assign to a control group. If you have inserted a luminaire field, you should activate the function "Allow single luminaires selection", because the possibility exists to select single luminaires. DIALux offers the option to add your luminaire arrangement(s) to one or several control groups. In the menu → *Paste* → *Control group*, as well as in the context menu in the CAD window or in the *Project manager* you can add your selected luminaire(s) to a new or existing control group.

Adding luminaire arrangement to control group

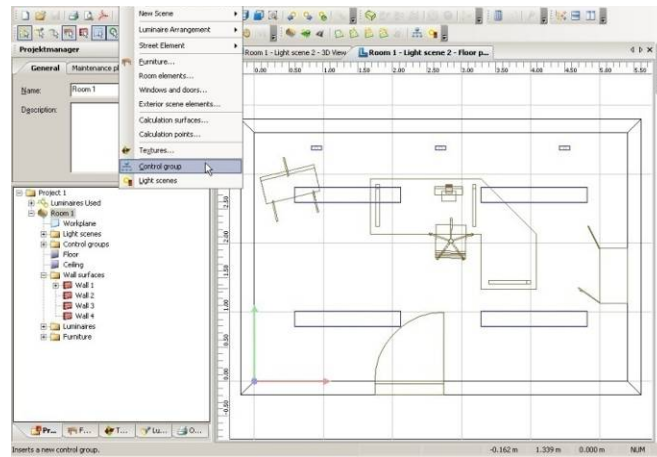

Fig. 208 Paste a control group via menu

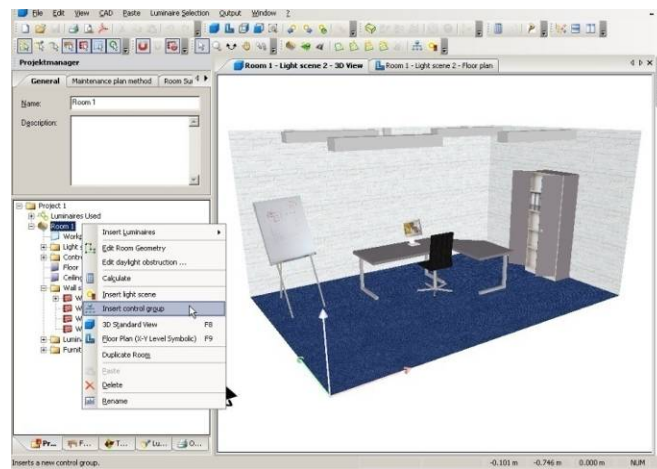

Fig. 209 Paste a control group – Context menu of the room

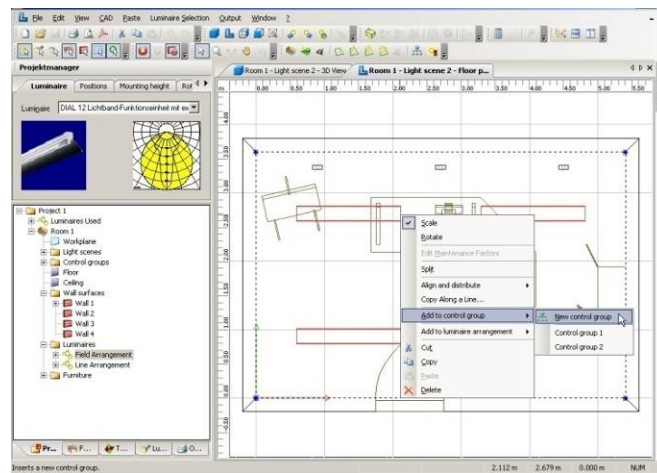

Fig. 210 Paste a control group – Context menu in the CAD view

Then in the *Project manager* the control group appears with a link to the luminaires. The control group has the Property Page Name.

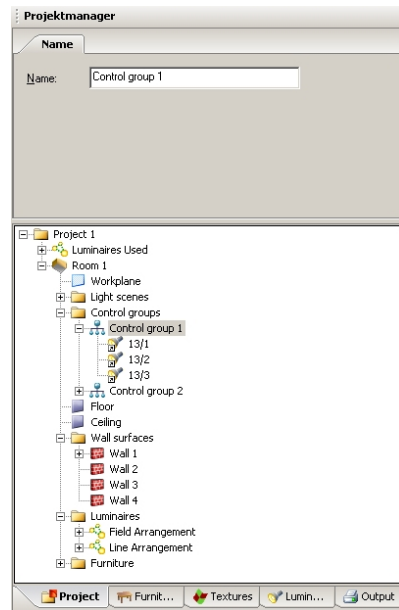

Fig. 211 Property Page of a control group

If luminaires are deleted, these are also removed at the same time from the appropriate control group, provided that these belong to a control group.

In the menu *Paste* you can insert a light scene in your project.

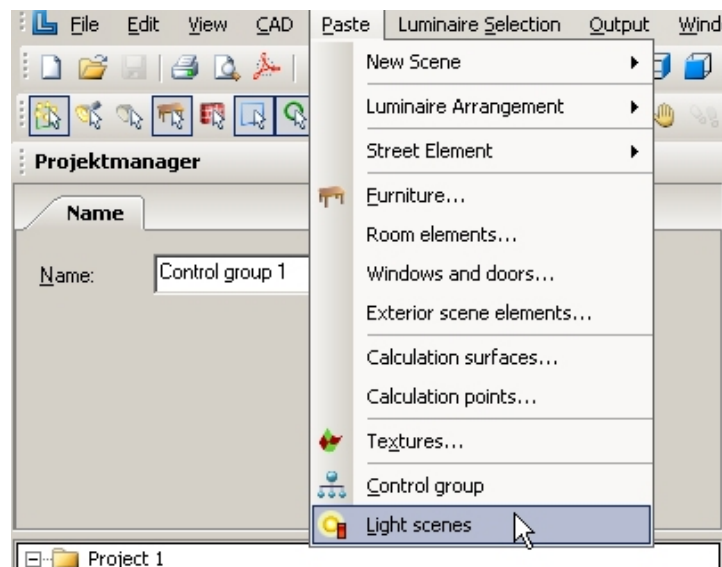

Fig. 212 Insert a light scene via menu

Alternatively you have the option to insert a light scene from the context menu of the room.

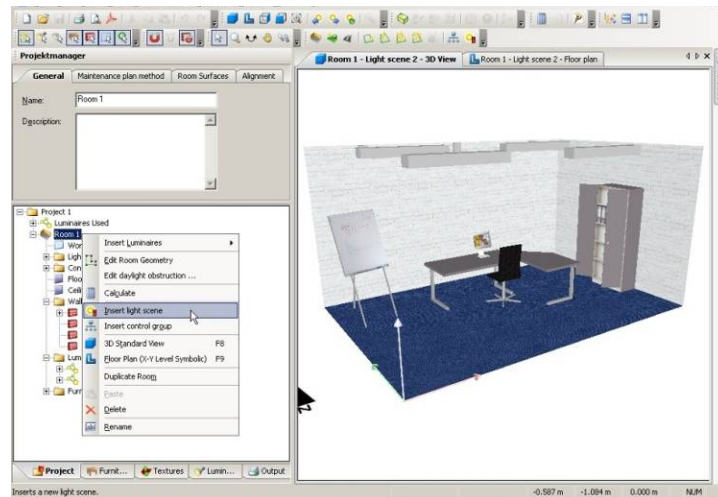

Fig. 213 Context menu of the room – Insert a light scene

If a control group was inserted already, you can access it by a right-click on the respective control group for the context menu and then add a new light scene. In Fig. 163 the suitable control group already exists.

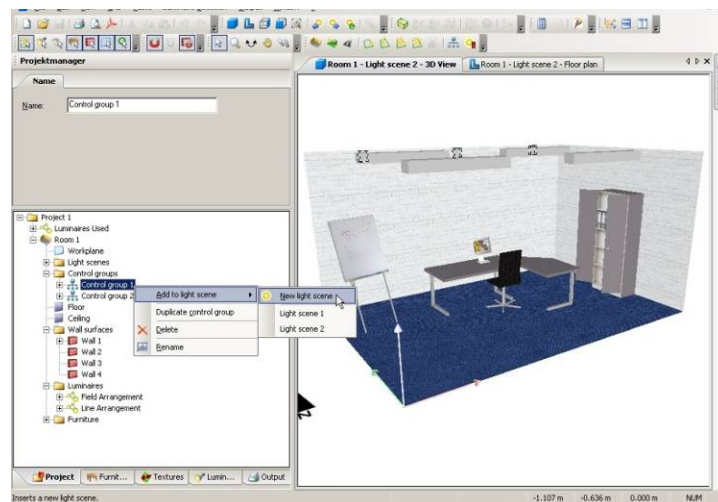

Fig. 214 Context menu control group – Add to light scene

If you select the light scene in the *Project manager*, the accompanying Property Pages open. The same happens to the control group available in the light scene. The Property Page *light scene* contains the name of the light scene which you can customise. DIALux has the option to define light scenes as an emergency light scene and to include the first reflection on the ceiling in the calculation (LG 12). You can make these adjustments in the checkboxes of the *light scene* Property Page.

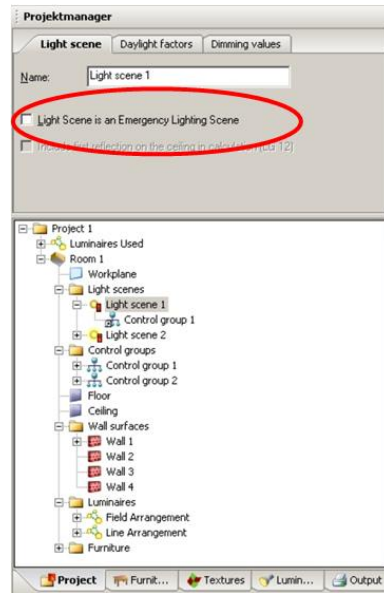

Fig. 215 Property Page of a light scene – Light scene

The *Daylight factors* tab enables the determination of the position of the sun for the daylight calculation. You have the option to make various settings in the *Inspector* with respect to daylight. Activate the checkbox *Take daylight into account during calculation*, that way you include the daylight in your project. If the checkbox is deactivated, the room is calculated without daylight. Individual or all light scenes of a room can be calculated at the same time.

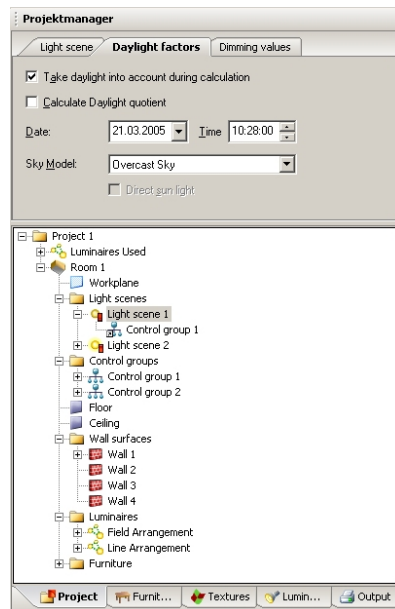

Fig. 216 Property Page of a light scene – Daylight factors

In the Property Page *Dimming values* the control groups with dimming levels are set in an editable list.

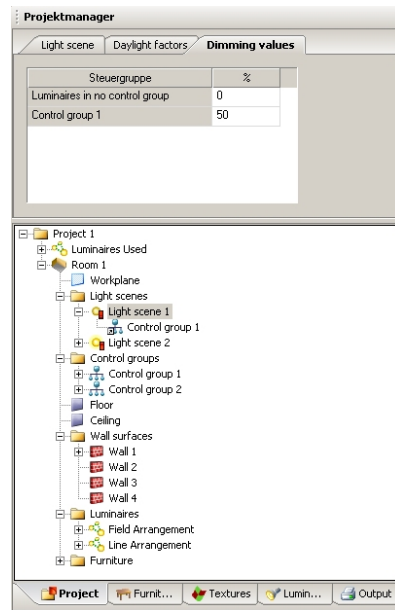

Fig. 217 Property Page of a light scene – Dimming values

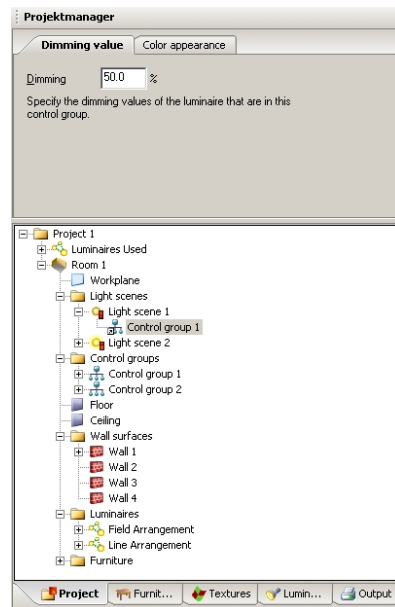

Fig. 218 Property Page of a control group – Dimming values

The user has the option to make set dimming levels of the used luminaires visible in the CAD view and to edit in the appropriate Property Pages. By means of the icons in the menu bar the dimming levels can be switched on and off. Also there is the option to change between individual light scenes with the arrows, provided that several light scenes exist.

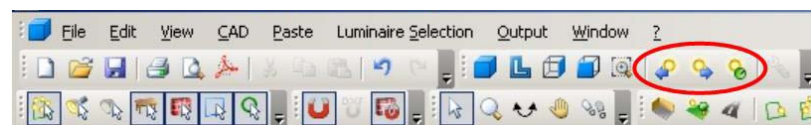

Fig. 219 Icons for showing dimming values and light scenes in CAD

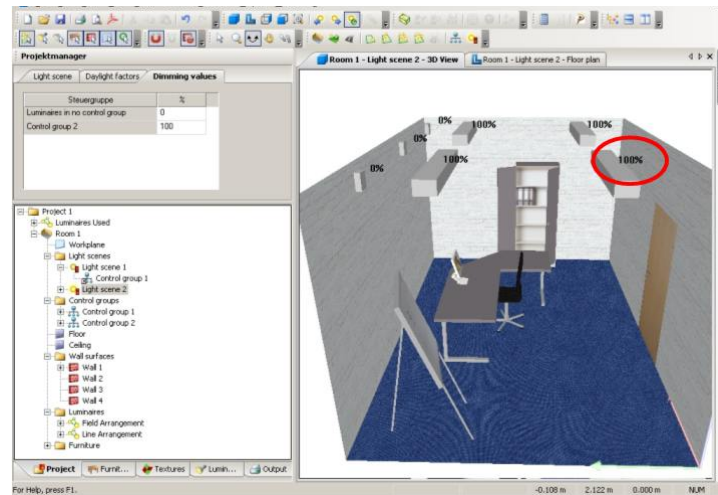

Fig. 220 Viewable dimming values in CAD

If luminaires with more than one light output are used, the dimming values for each light emitting object (LEO) can be adjusted separately. In the Property Page of the control group in the lighting scene, you can define the dimming values for each LEO. This dimming value will be multiplied with the dimming value of the control group. Example:

The control group will be dimmed to 100%. In this control group there is a luminaire with independent direct and indirect light output. The direct light should be switched off; the indirect light should be completely on.

Settings:

Dimming value of the control group: 100%

Light output direct: 0%
Total: $100\% \times 0\% = 0\%$

Light output indirect: 100%
Total: $100\% \times 100\% = 100\%$

If the indirect light should be dimmed to 50%, you can either dim the control group or the LEO.

Either:

Total: $50\% \times 100\% = 50\%$

Or

Total: $100\% \times 50\% = 50\%$

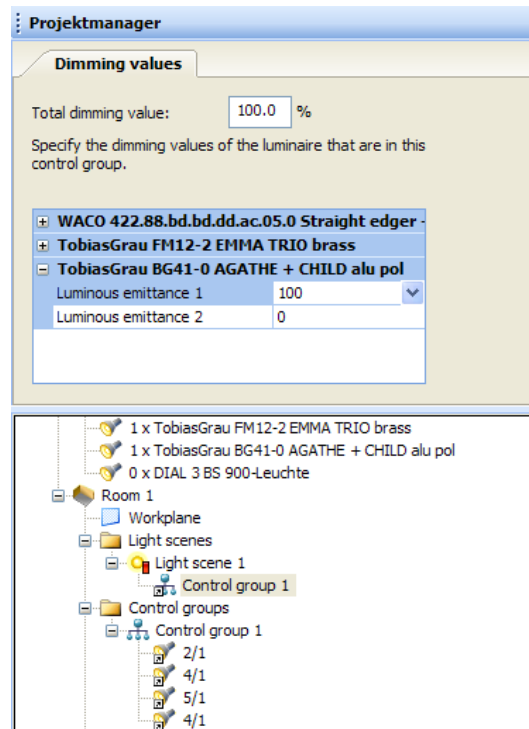

Fig. 221 Dimming individual light outputs separately

If no light scene is inserted in the room, only the room is calculated as before.

Modify light scenes and control groups

You have the potential to duplicate light scenes as well as control groups. In this manner the task is made easier for you if the same lights with different dimming levels are to be used. You can find this function in the context menu of the light scene or control group.

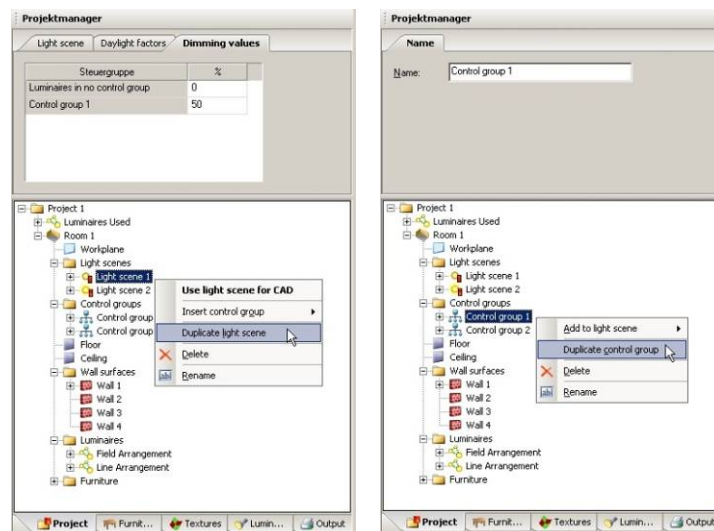

Fig. 222 Duplicate light scene or control group

The function of brightness distribution in the calculated room can be accessed in the menu *File* → *Settings* → *Adjust Brightness*

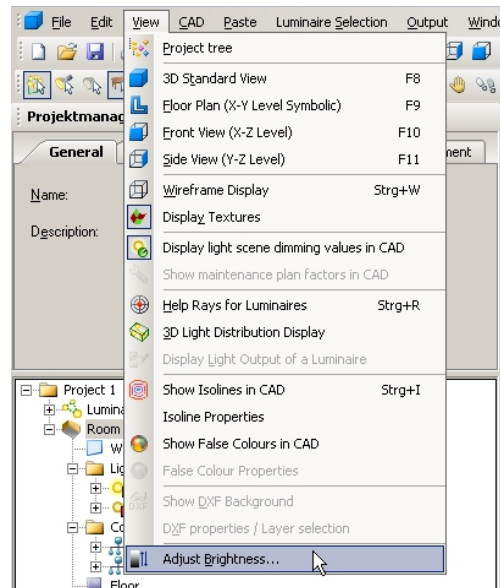

Fig. 223 Adjust brightness via menu

or in the context menu within the CAD window.

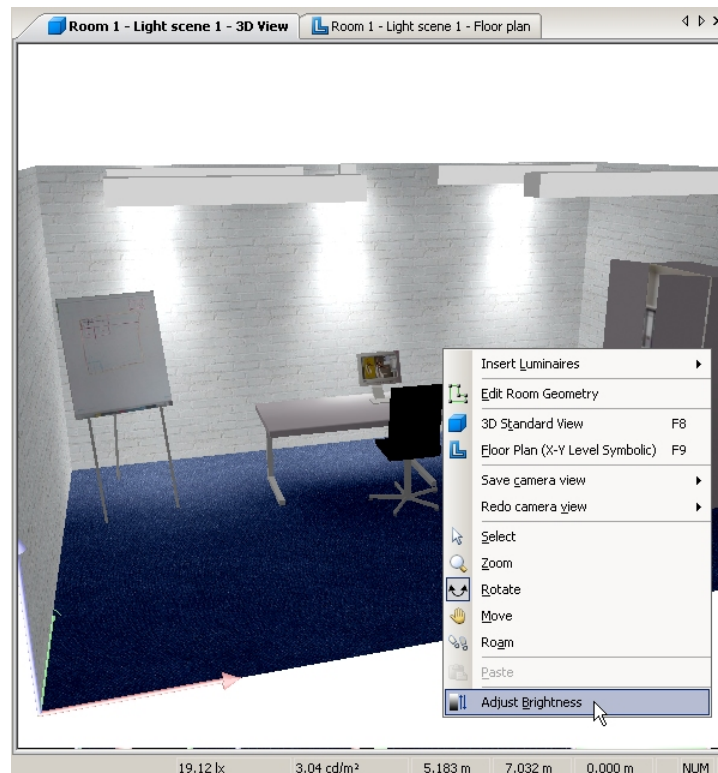

Fig. 224 Adjust brightness – CAD window

The Property Page *Brightness* allows the setting of the brightness distribution in the room. After you have shifted the brightness control in the desired position, click on the *Apply* button, so that the currently displayed window can be refreshed in your 3D Rendering.

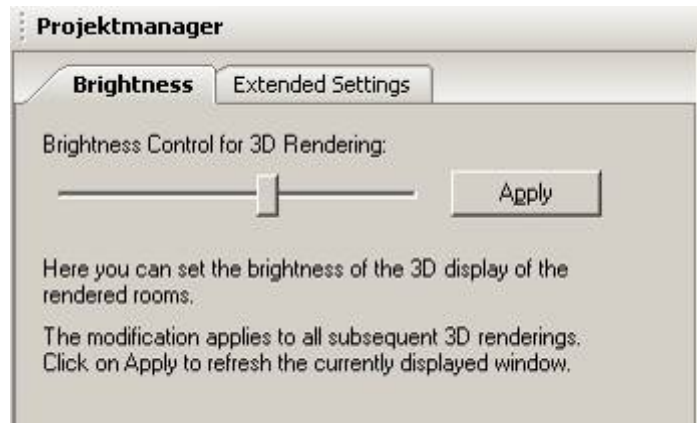

Fig. 225 Brightness control for 3D rendering

In the *Extended Settings* tab you can correct the exposure time of the CAD. Additionally you have the option to optimize light scenes together by means of the checkboxes.

Light scenes can be optimized together

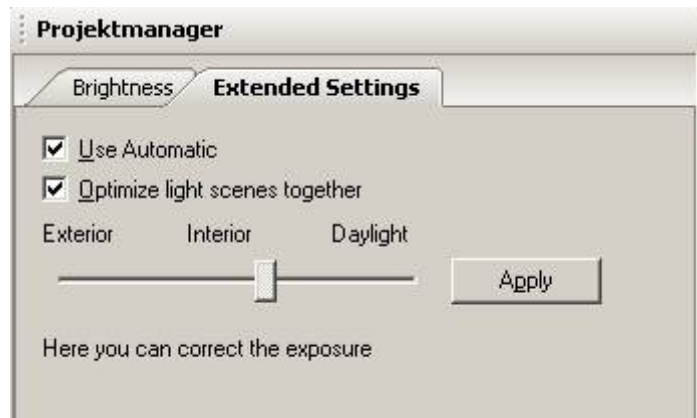

Fig. 226 Extended settings

Export of light scenes

Export light scenes in *.dlc format

Now DIALux offers the option to export light scenes in the *.dlc format (**DIALux Light Control**). You find this function in the menu *File* → *Export* → *Save DIALux light scene file...*

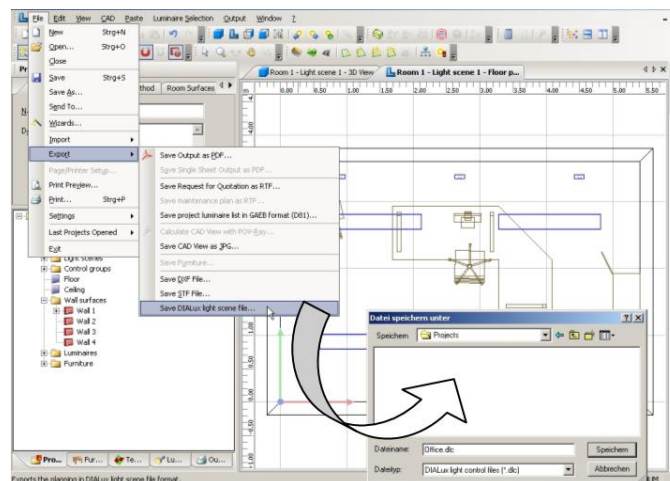

Fig. 227 Export of light scenes

Emergency lighting

Global

Emergency lighting can be calculated according to the European standard EN1838. In the introduction of the standard EN 1838 on page 2 it is stated that only the direct light has to be taken into account and not the reflected (indirect) component for the calculation of the emergency lighting scene. Also the special regulation of the Lighting Guide 12 (LG12) from the SLL in the UK, that the first reflection of direct light onto a ceiling is selectable for the calculation. In DIALux additional calculation methods are required for escape route lighting and open area lighting.

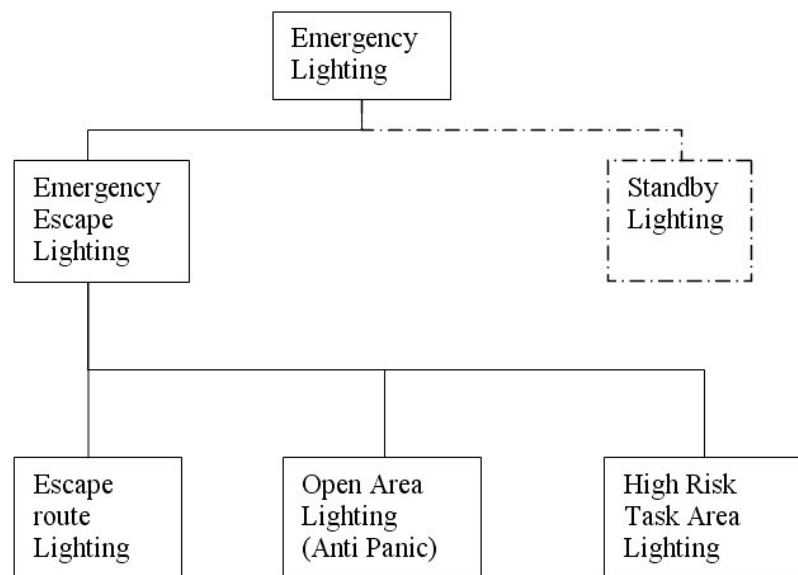

Fig. 228 Types of emergency lighting

Standby lighting is calculated like a regular lighting design. The option to do an emergency escape lighting design is available when a lighting scheme is inserted into a DIALux project and it is set to an emergency lighting scheme. Because the emergency situation and lighting is often integrated into a regular lighting design and realised with luminaires which are in use also for the regular lighting, this reduces the work the designer has to do. You are able to select those luminaires, which are used for emergency lighting from all the luminaires placed in a room and you can also place additional luminaires which are only used in an emergency. Such luminaires, which are only used in the emergency case, are not taken into account in the "regular" lighting calculation. But these luminaires are placed and they are listed for the outputs to locate them for the commissioning. You can select for each luminaire whether it is used in the regular lighting, in the

emergency lighting only or for both cases. The duration time and the luminous flux can be set for the emergency case. The dimming of luminaires and taking daylight into account in an emergency lighting scheme is of course not possible.

To create an emergency lighting scheme you just have to select the desired room and make a right click to add a lighting scheme.

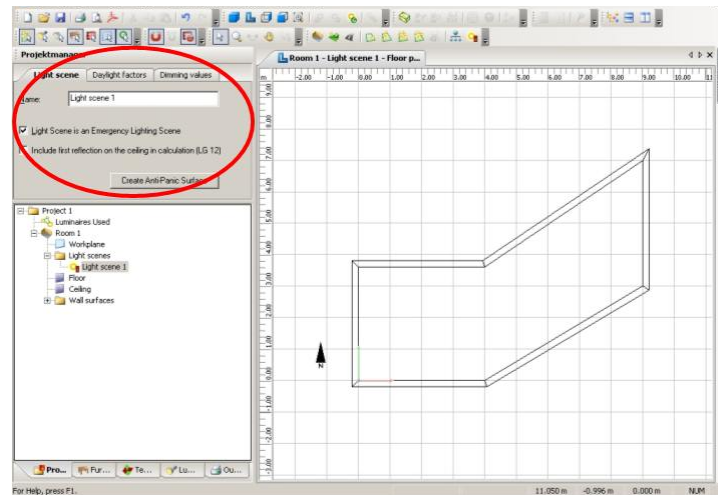

Fig. 229 Emergency lighting scene

If you want to design an emergency lighting project for the UK market, it will be possible to define here the calculation according to Lighting Guide 12, to take into account the first reflection of direct light on the ceiling(s). This, of course, will be automatically switched on if the user selected the standard settings according the UK market (global options, like UGR SHR and illuminance quotient).

You can define for each light emitting object whether it is used for emergency lighting.

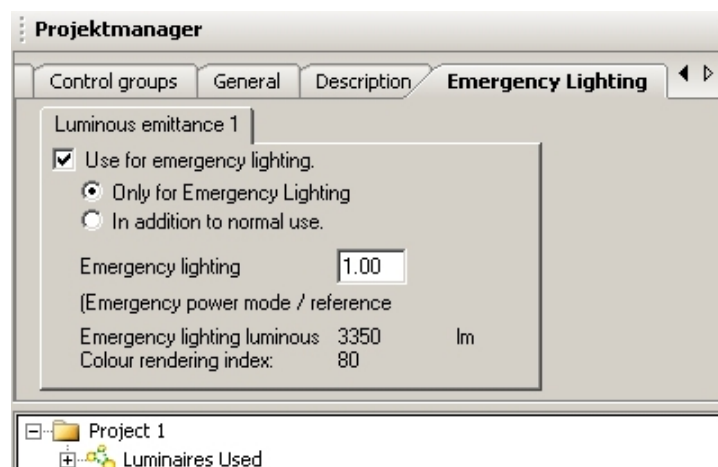

Fig. 230 Property Page of emergency lighting

For each luminaire and each LEO (Light emitting object, a luminaire may have more than one light output) of a luminaire, there will be a luminaire data sheet for emergency lighting available. This datasheet offers important information about the LEO. The first one will be a graphic for the "Disability Glare Zone". In this graphic the maximum intensity values of EN1838, Table 1 will be listed and in two sketches the maximum intensity values of the LEO for the "flat floor" and for the "uneven floor" will be given. The second graphic / table will show the maximum distances for the mounting of the luminaire to achieve a desired illuminance (for example 1 lx). It will list several mounting heights (2m up to 5m) and the mounting options: wall to transverse, transverse to transverse, transverse to axial, axial to axial and axial to wall.

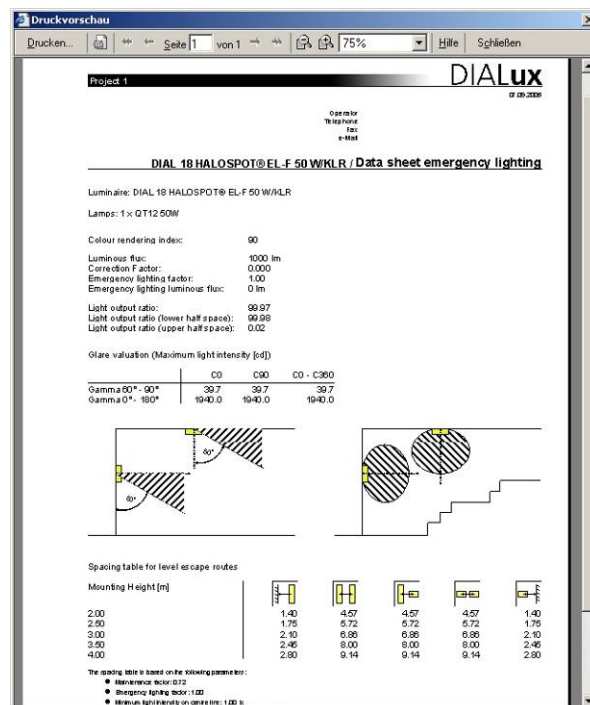

Fig. 231 Output – Emergency lighting data sheet

Escape route lighting

To do an escape route design, you have to insert one or more escape route calculation object(s). The escape route can be edited by entering the coordinates or by moving with the mouse. With a right click additional points can be inserted to add a kink to the escape route. The width can be set to a maximum of 2m.

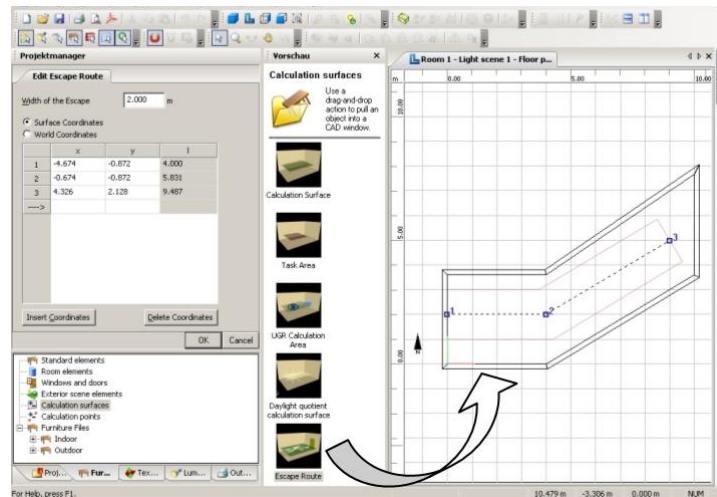

Fig. 232 Emergency lighting – Modify escape route

The surface is placed on the floor but you can move it around freely. After placing these escape route object(s) a luminaire has to be selected. With a right click on the escape route, a luminaire arrangement of single luminaires can be placed above the escape route.

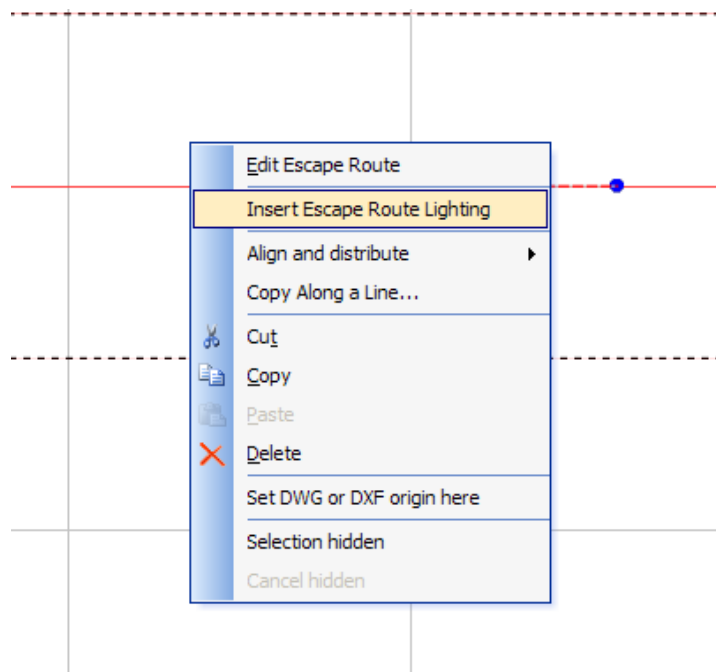

Fig. 233 Emergency lighting – Insert escape route lighting

You can select the luminaries you want to use, you can define the luminous flux, which LEO to be used (if there is more than one) and you can define a desired illuminance level to be reached on the escape route. The maximum distances for the first luminaries and between the luminaries are calculated and used for the positioning of the luminaries. Also you can select if there should be luminaries in the positions of the kinks of the

escape route. If necessary, there can be more than one escape route and luminaires arrangement in a room.

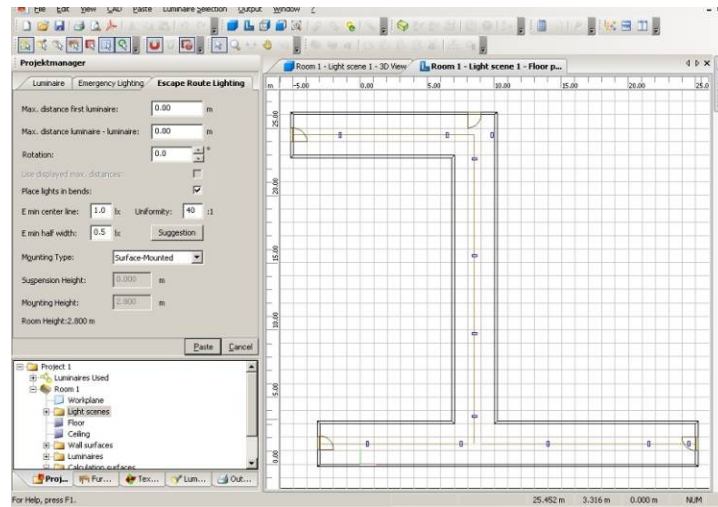

Fig. 234 Escape route lighting

Before the escape route with the escape route luminaires is planned, normally the positions of luminaires are also defined by the positions of "MANDATORY POINTS OF EMPHASIS". Initial design is conducted by situating luminaires to reveal specific hazards and highlight safety equipment and signs, in addition to providing illumination to assist safe travel along the escape route. This should be performed regardless of whether it is an emergency escape route or an open (anti-panic) area. As seen in this visualisation, the manufacturer can use real 3D models for the visualisation of its luminaires.

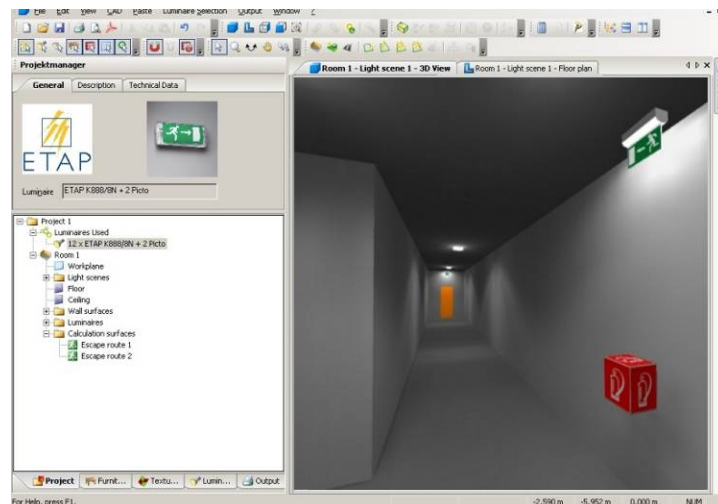

Fig. 235 Escape route lighting – Visualisation

Open area lighting (anti panic)

Open area lighting can be automatically prepared by inserting an emergency lighting scene. In the Property Page for the lighting scheme there is a button to insert "anti panic calculation surfaces" on each piece of floor in the room, even if the floor is tilted or consist of areas

in different heights. The geometry is copied from the floor minus 0.5m from the walls. It is also possible to edit the surfaces manually.

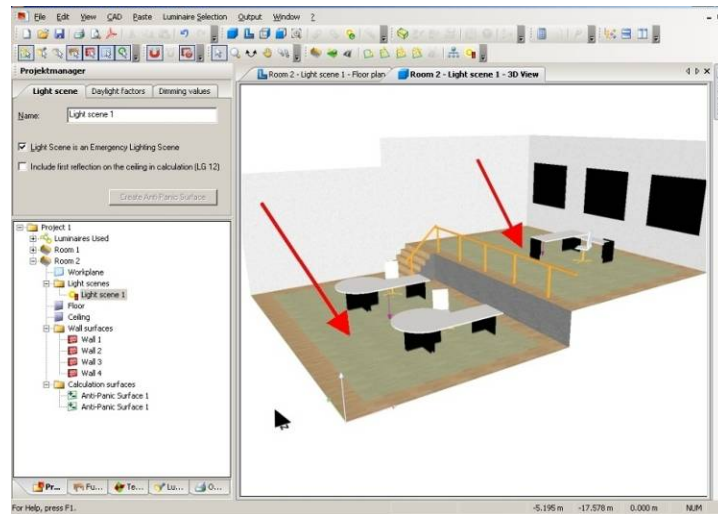

Fig. 236 Open area lighting

The way to insert an open area luminaire arrangement is similar to that in the escape route lighting. A right click on the open area calculation surface opens the Property Page for the luminaire arrangement.

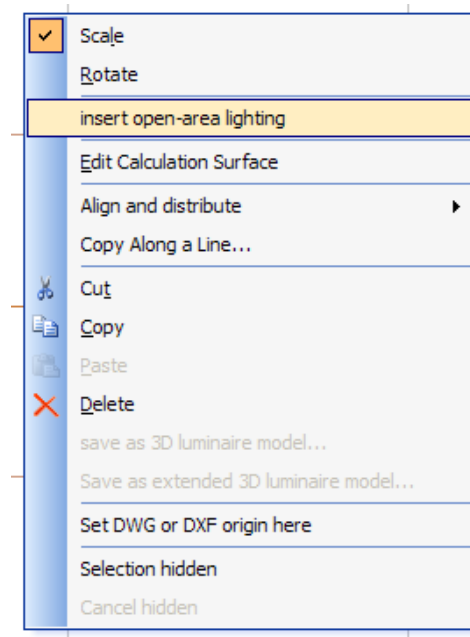

Fig. 237 Insert open area lighting

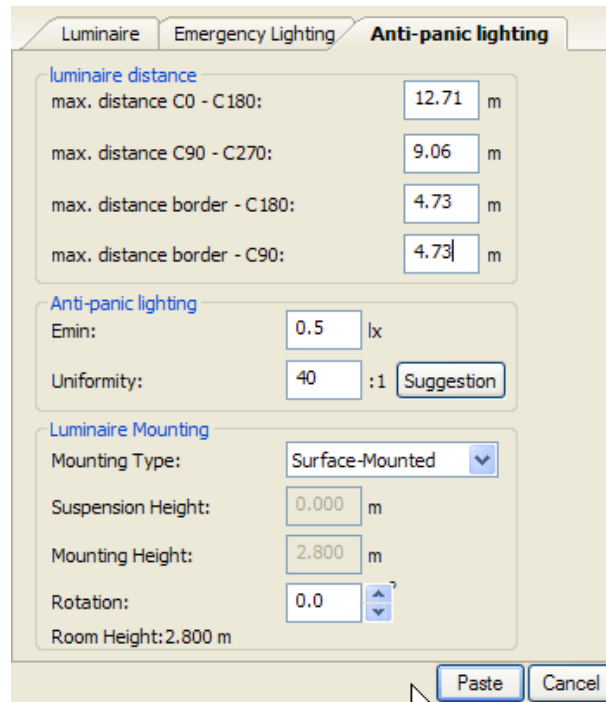

Fig. 238 Properties of the open area luminaire arrangement

This tool calculates the maximum distance for the selected fittings taking into account the desired minimum illuminance level and uniformity. You can see here the maximum distance lengthwise and crosswise between the luminaires and between luminaires and the border of the open area calculation surface. The arrangement will be placed symmetrically above the open area surface.

To calculate the “open area” which means the unobstructed floor, you have to select in the calculation setting not to take the furniture into account.

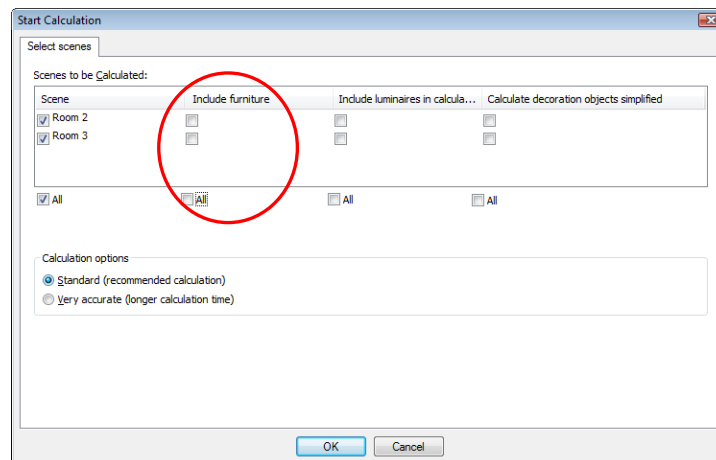

Fig. 239 Calculation dialogue – Without furniture

Those luminaires, which are in use for emergency lighting, are marked with the expression “emergency luminaire”.

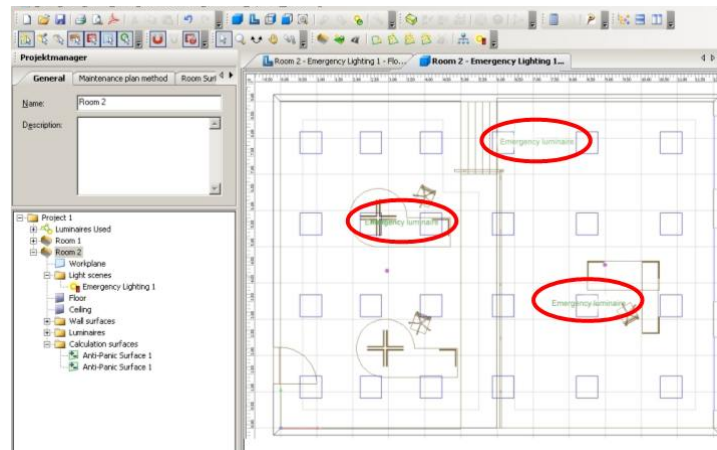

Fig. 240 Emergency luminaires in the CAD view

High risk task area lighting

For the high risk task area lighting, you can use the regular task area calculation surface of DIALux. It contains of the task area(s) and the surrounding area. The calculation surface will be calculated in the emergency lighting scheme as well as the other calculation surfaces.

Luminaires with emergency lights

A luminaire can transfer the information of several light emitting objects. These LEO can also be defined as "emergency LEO". These emergency LEOs are only used for the emergency lighting calculation. Since DIALux version 4.1 these emergency LEOs will be used by DIALux for the emergency lighting calculation. A "regular" LEO can also be used for the emergency calculation. Often "normal luminaires are equipped with battery packs or they are connected to a central battery. So in the emergency case the "regular" light distribution curve is used for the calculation. Maybe the luminous flux is different. In DIALux a single luminaire can be picked and the settings to use it in the emergency lighting calculation can be defined.

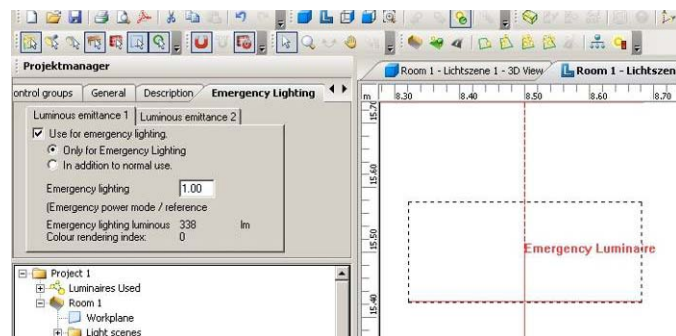

Fig. 241 Emergency lighting – Inspector

You can define here if the luminaire has to be used for the emergency calculation. Also you can define if it is used only in the emergency case or for the normal

lighting. The luminous flux for the duration time can be edited here.

The emergency LEO is designed to handle a light distribution curve which is different from the regular LDC. There are for example fluorescent lamp luminaires on the market which have an incandescent lamp or a LED included for emergency lighting. In these cases it would be possible to use the fluorescent lamps LDC for the normal lighting situation and the incandescent lamp or LED LDC for the emergency lighting.

Emergency lighting data sheet

One element of good lighting design is of course complete lighting documentation. In accordance with prEN 13032-3 DIALux also provides evaluation of emergency luminaires with regard to glare and optimal positioning in the form of a data sheet.

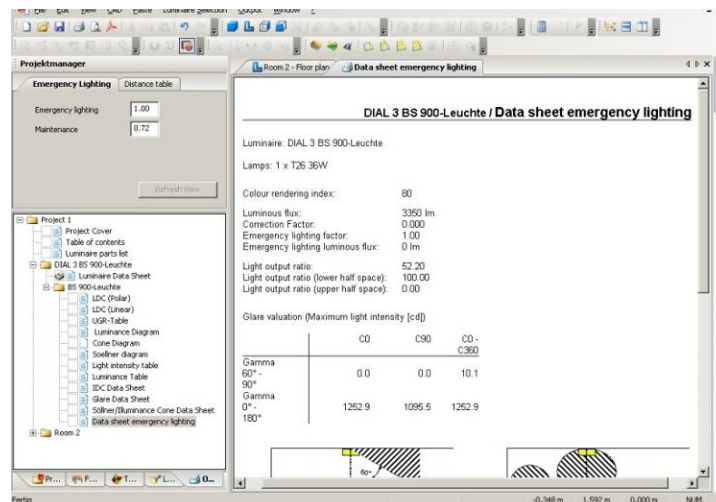

Fig. 242 Emergency lighting data sheet

Daylight calculation in DIALux

DIALux is complemented by the extensive support of daylight calculations. Now daylight scenes can be inserted in your project allowing the influence of daylight in the interior and exterior scenes to be simply calculated. The different sky models (clear, overcast, partially overcast), as well as the direct sunlight influences the calculation. Of course location, time and alignment, as well as the daylight obstruction are taken into consideration with the calculation.

Basics

Since the introduction of version 4 DIALux can calculate daylight. No special mode is necessary for this. In exterior scenes daylight can be calculated basically, and in interiors whenever windows or skylights exist in the room. As a base for the calculation the DIN 5034 and the CIE publication 110 were used. The sky dome is divided into parameterised luminous surfaces, which get a luminance depending on the sky model, location, date and time. By the option "use direct sunlight" it is also calculated with the sun as a light source. The calculation occurs in the following steps:

1. Calculation of the skylight on all surfaces (inside and outside)
2. Calculation of the direct sunlight on all surfaces
3. Calculation of the direct light of luminaires (if available)
4. Calculation of the indirect component

DIALux does not differentiate between inside and outside calculations; all surfaces are simply used for the radiative interchange. If you want to do a daylight calculation in DIALux, a suitable light scene must be inserted.

Sky types in DIALux

The sky types in DIALux correspond to the CIE 110-1994 "Spatial Distribution of Daylight - Luminance Distributions of Various Reference Skies". Thereby a luminance is assigned to every point of the sky. The luminance depends on the solar height, the solar azimuth, the sky point height and the sky point azimuth.

	Overcast Sky	Averaged Sky	Clear Sky
CIE-Name	Overcast Sky	Averaged Intermediate Sky Developed by Nakamura, Oki et al.	Clear Sky
Description	Complete Overcast Sky, rotationally symmetrical luminance distribution	Developed from a long period of measurements, described average weather conditions	Cloudless Sky
Direct sun possible	No	No	Yes
Number of possible zenith luminance	3	1	8
In DIALux used zenith luminance	Krochmann		Krochmann

Light Scenes

DIALux offers the possibility to define light scenes in a project. For this a light scene is inserted within the room or the exterior scene by right-click or insert-menu. In light scenes luminaires can be provided individually or as control groups with dimming levels. Likewise a daylight situation can be defined.

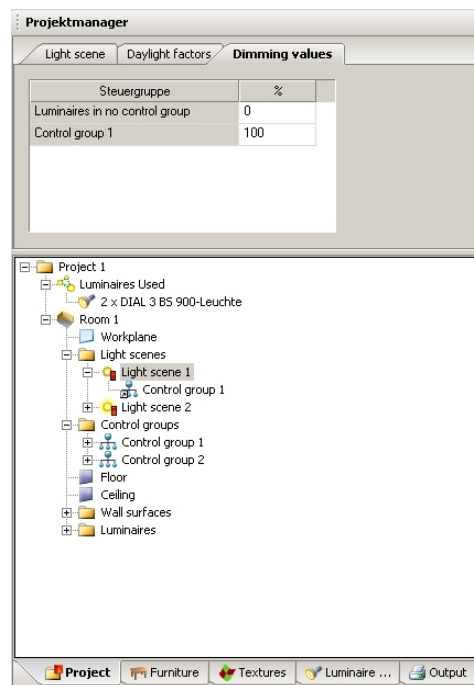

Fig. 243 Specify dimming values of the control group

To accomplish a daylight calculation, a light scene must exist in the room.

Daylight calculation

If a project is started, the global position must be defined first.

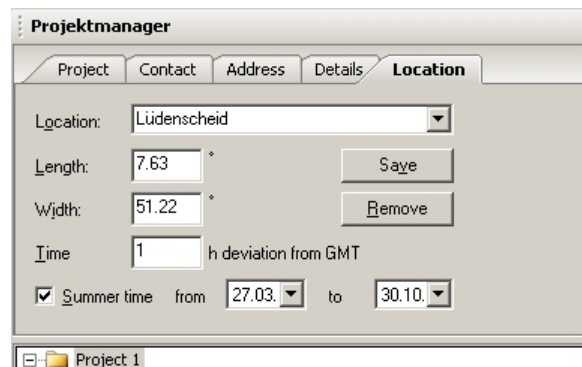

Fig. 244 Select the location

Here the user can select any location. DIALux offers a very long list of places on all continents, so that the inputs are already filled for longitude and latitude as well as time zone. Other places can be added arbitrarily.

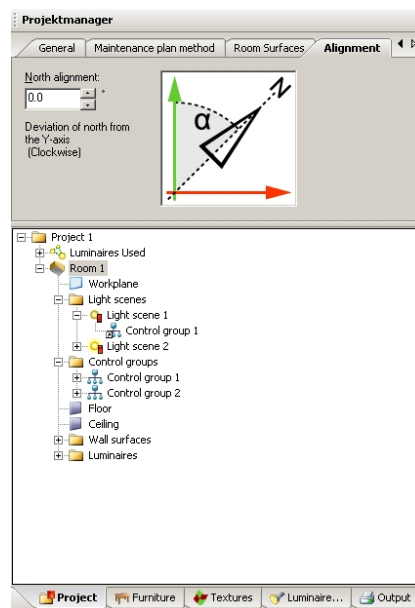

Fig. 245 North alignment

The north direction can be defined in each case for the room or the exterior scene. To recognize this easily, the north arrow is drawn near the coordinate origin.

In the room windows or skylights must be included in the plan as before. These can be easily placed as a line or field if one uses "Copy along a line" function.

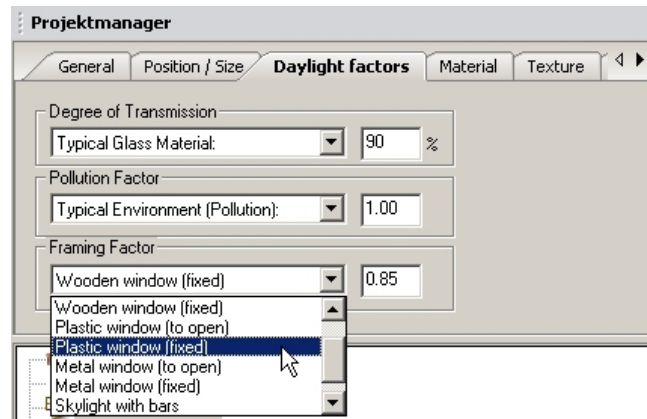

Fig. 246 Edit daylight factors

Of course all the important parameters can be defined for windows and skylights. As usual DIALux already includes a selection of the most current choices.

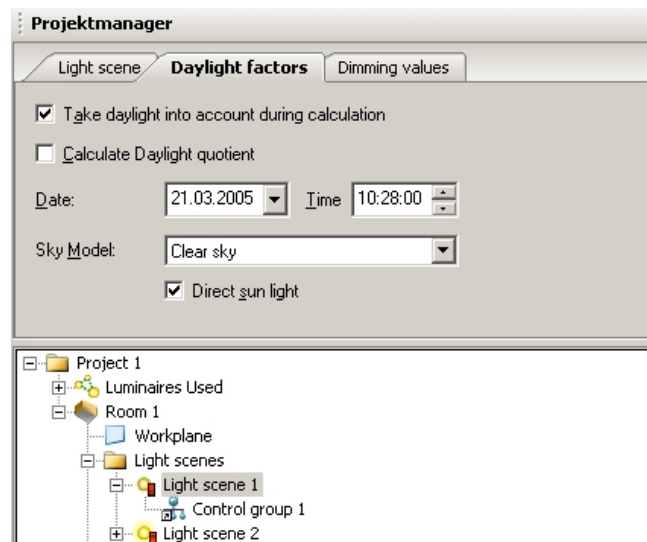

Fig. 247 Daylight factors

To calculate a light scene with daylight, the necessary calculation options must be put in the light scene. If the checkbox "Calculate Daylight quotient" is activated, the settings are made accordingly:

- Sky model of overcast sky
- No sun
- No consideration possibly of available luminaires

As a result you get as usual a calculation including visualization, and in this case, the output of the daylight quotient as a component of the work plane. If you want to know the daylight quotient at other positions, you can insert suitable calculation surfaces or calculation points.

In the following figure the value chart of the work plane is displayed. Currently (beta version) it doesn't show the daylight quotients, but just the illumination in the

suitable positions. Also the outputs for D_{min} , D_{max} and D_m need to be shown as percentage values.

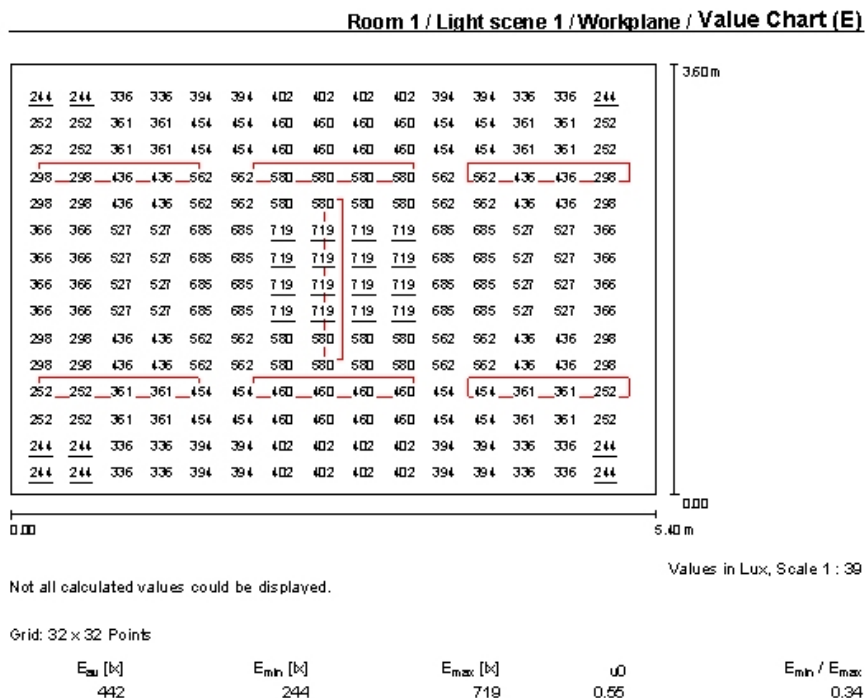

Fig. 248 Output – Value chart of the workplane

Obstruction

Of course the obstruction can be also taken into consideration in DIALux. For this it is also necessary to define this in the CAD. By the selection "Edit daylight obstruction" in the menu *Edit* or by right-click on the room the obstruction can be inserted. In the obstruction scene the room is shown in its exterior view. Now objects can be planned arbitrarily round the room. Also the room can be raised if it necessary, e.g., a room in a higher floor. The obstruction shades the direct light as well as the reflected light which hits the obstruction objects.

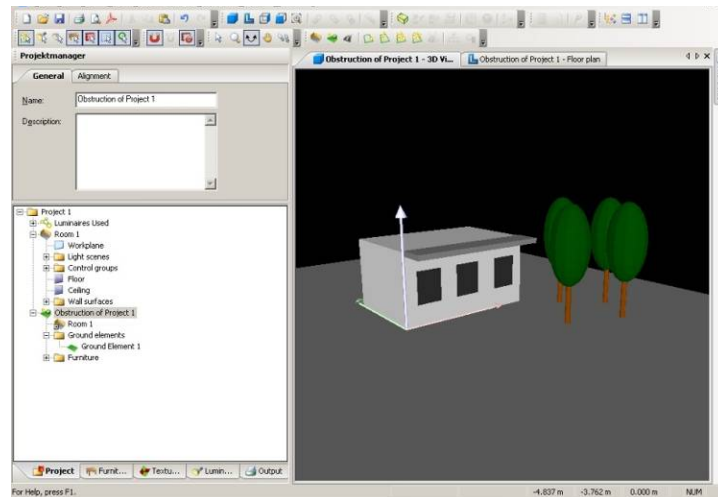

Fig. 249 Obstruction in CAD view

Sun and shadow visualisation

The direct incidence of sunlight in the room can be simulated on a real-time basis. For this an OpenGL compatible graphic card is necessary. The incidence of light by windows and/or skylights is calculated as a function of place, orientation, geometry and date and time.

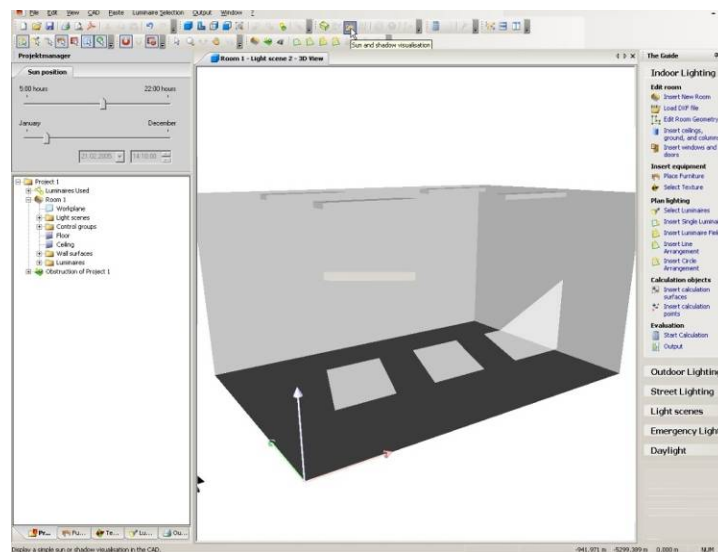

Fig. 250 Sun and shadow visualisation

At the top left of the *Inspector* there are two sliders. With these the date and time can be changed on a real-time basis and the path of the incidence light in the room can be simulated.

Settings in the calculation dialogue

Before starting the calculation you have the possibility to select the scenes to be calculated in the calculation window. Other settings are available. Thus you can select additional calculation options and operations.

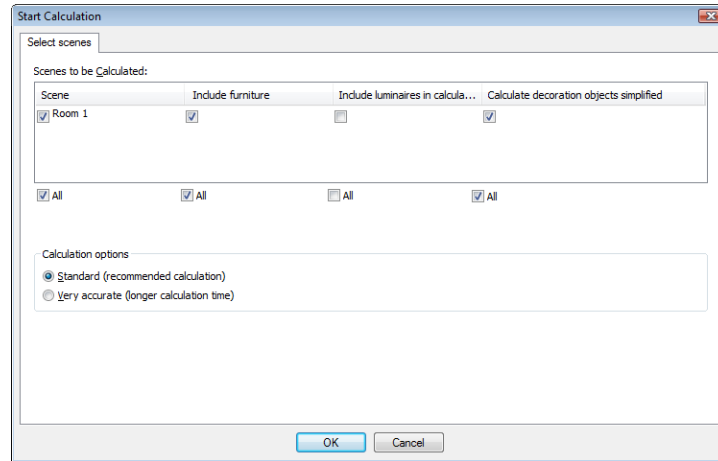

Fig. 251 Calculation dialogue

Working in the 3D View

Setup the 3D View

It is possible to roam through a planned scene to closely evaluate the results. The observer's position can also be inside a room. This is especially valuable when planning large rooms with a lot of furniture.

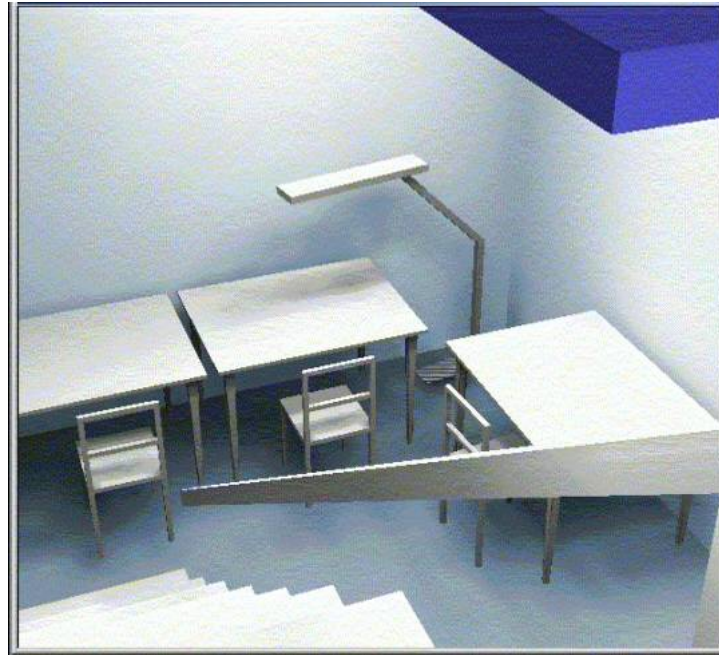

Fig. 252 Evaluating a staircase from the upper storey

If you have a "three-button mouse", the "Move" option is assigned to the mouse button in the middle. If you have a wheel mouse, you can "Zoom" by turning the wheel and "Move" by pressing it.

The following tools (from left) can be used to change the position in the 3D view:

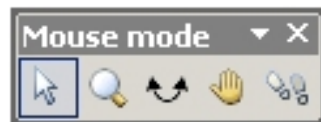
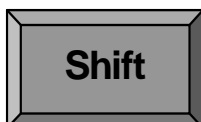
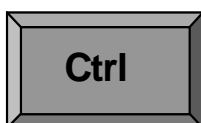

Fig. 253 Toolbar for switching between modes

- Select Objects; when this mode is selected, objects (depending on the selection filter) can be selected by clicking on them.
- Increase/Decrease View Size; to increase or decrease the zoom factor, left-click in the CAD window and move the mouse up or down. With DIALux 4.9 you can increase or decrease the CAD view about 10% by using *CTRL* key + + or *CTRL* key + -.
- Rotate 3D View; left-click and move the mouse while holding the mouse button pressed.
- Move; use this mode to move the area that is displayed in the window. If you have a "three-

Various options are available when roaming through a scene!



button mouse”, this option is always assigned to the mouse button in the middle.

- Roam Scene
 - Left-click and move the mouse to move forward, backward or to rotate on the spot.
 - Left-click holding the *CTRL* key \Rightarrow you can roam up, down, left or right, the viewing direction remains constant.
 - Left-click holding the *Shift* key \Rightarrow you remain on the spot and can look around you.

You can change the focal distance of the camera in the 3D view by selecting the mouse mode “zoom” (loupe symbol). While zooming (left-click and move the mouse) hold the *CTRL* key at the same time.

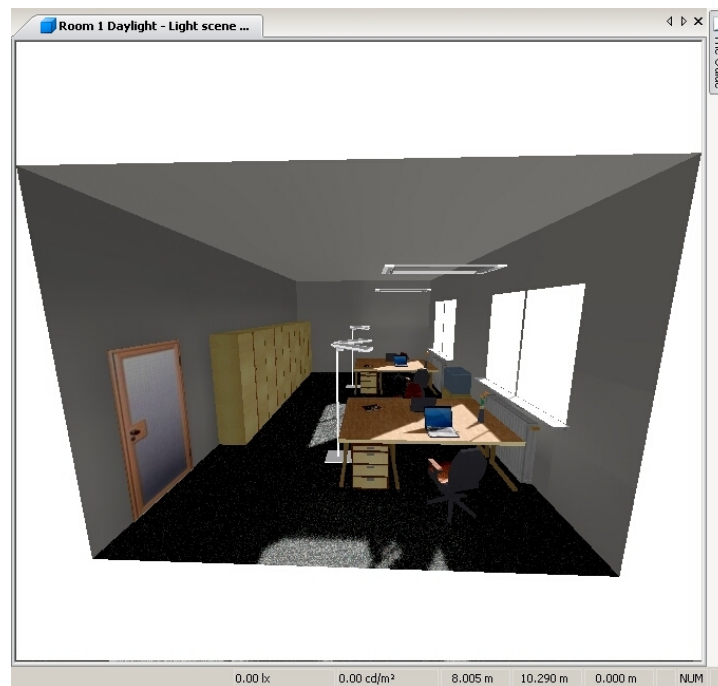

Fig. 254 Change perspective and focal distance of the camera

Check Calculation Values in the 3D View

With the help of the *Luxmeter* function you can see the calculated illuminance value of any selected point. To do this you should switch to the 3D view, enable the *Tool tips for calculation results* and select the *Rotate view* mouse mode. Move the mouse pointer to any position in the CAD window. The calculation results are displayed at the bottom of the figure. In order to indicate different points of calculation in your CAD window set your mouse function to *Rotate View*. This way you can quickly reach each point in the room.

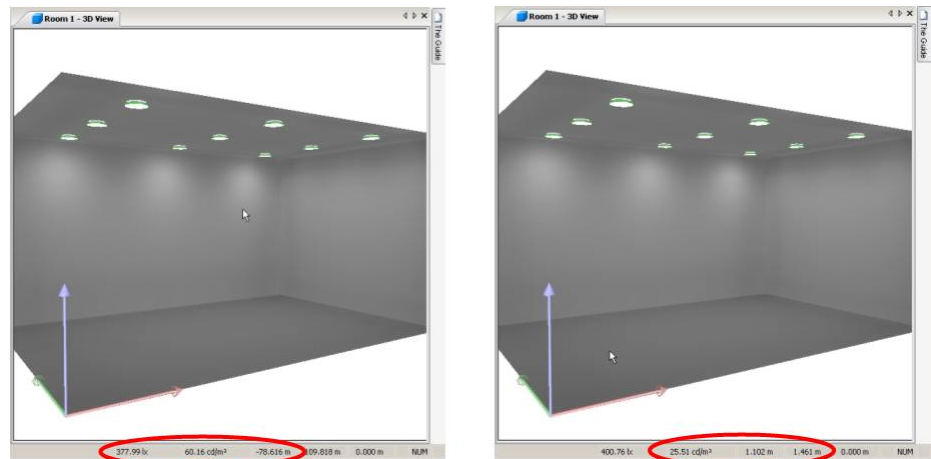

Fig. 255 Show calculation results in 3D view

Now you can click at any point that is of interest to you and the calculated illuminance is displayed in a small tool tip.

Save 3D View

DIALux offers two different ways to export the current 3D rendering into a graphics file. The easiest way to get a picture of the visualisation is to rotate or move the 3D view of a scene (interior room, exterior room or street) into the desired position and then use the menu → *Export* → *Save CAD view as JPG...* which opens a file selection dialogue.

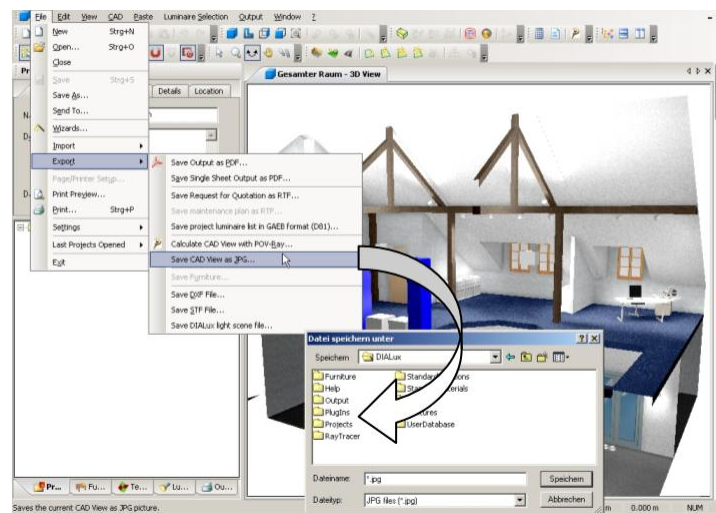

Fig. 256 Save a 3D view as *.jpg-file

Here you can enter the directory and the filename. The picture is stored as a *.jpg-file with a 1024 x 768 pixel image.

To get a picture with a higher resolution, proceed as follows:

- Make the planning as usual and adjust the perspective of the 3D CAD view.

- Change to the output and open the 3D rendering.

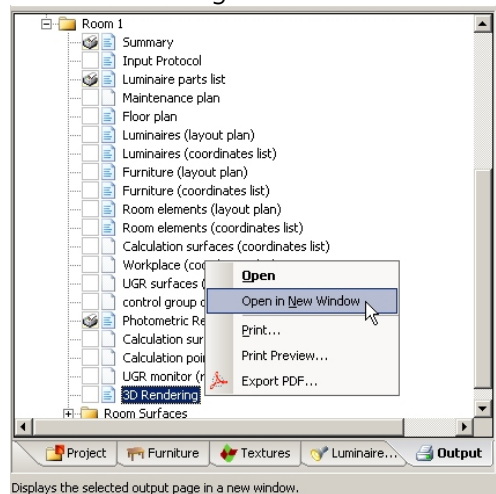

Fig. 257 Open the 3D rendering

- Start the software that should import the image. This might be Word, Excel or any image processing software.
- Click and hold the left mouse button on the 3D output and drag the image to the other program.

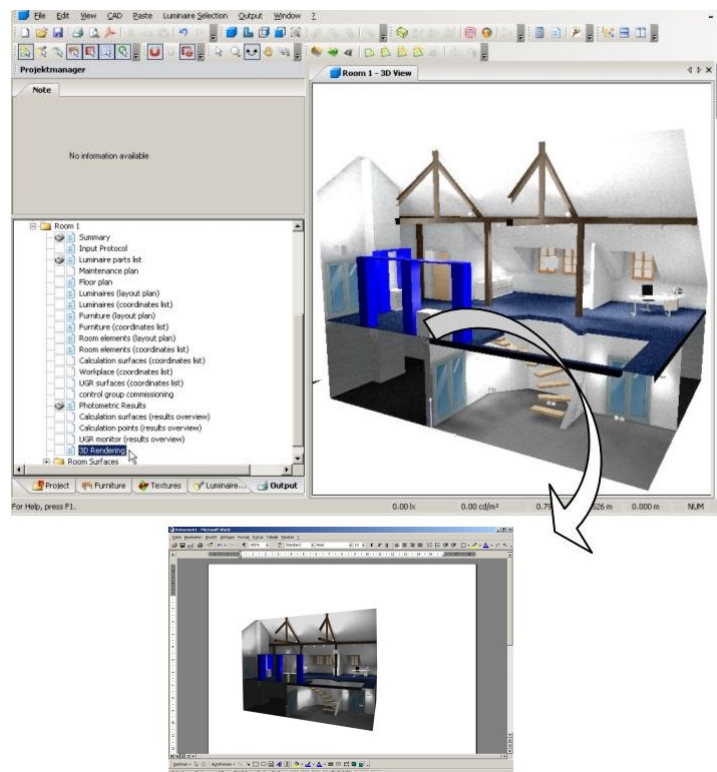

Fig. 258 Copy the 3D rendering into another software

- The image is copied into the other software with a resolution of 2000 x 2000 pixels.

Presentation of false colour rendering

With DIALux the user has the option to display the 3D rendering in a false colour rendering presentation. The presentation of illuminance and luminance with freely scalable value ranges and definable colour gradients is now available.

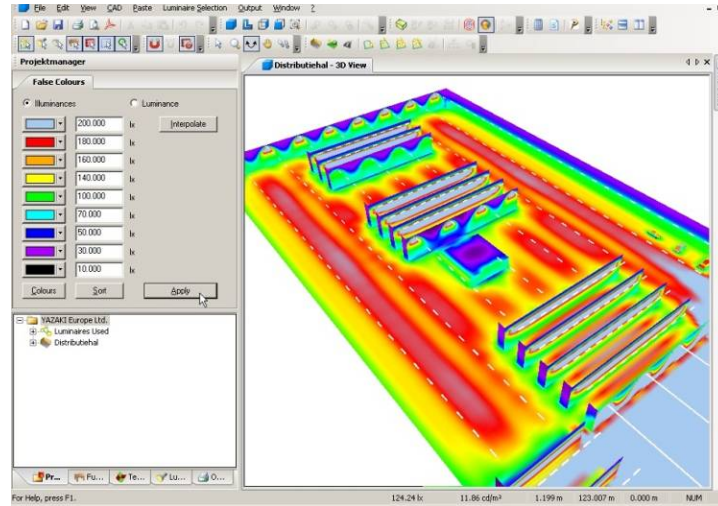

Fig. 259 False colour – Illuminances

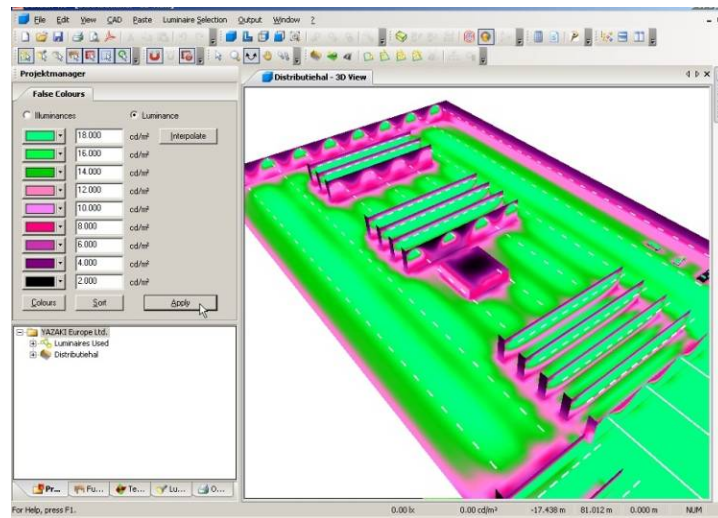

Fig. 260 False colour – Luminance

Working in Various Views

DIALux provides various views to assist you with your layout.

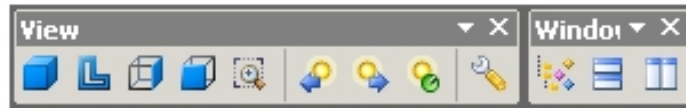

Fig. 261 Views toolbar

You can open the various views via the toolbar illustrated. The button functions are, from left to right:

- Open 3D view
- Open ground plan view
- Open side view
- Open front view
- Zoom to the overall view of the scene, for that DIALux zooms to the borderline of the room or exterior scene
- Show previous / next light scene
- Show dimming levels in CAD
- Show maintenance factors in the CAD
- Activate *Project manager*, DIALux shows the *Project manager* in addition to *The Guide*
- Tile windows horizontally
- Tile windows vertically

In the menu file *Settings* → *Customise Toolbars* you can activate more functions in the view's or window's toolbar (see page 54).

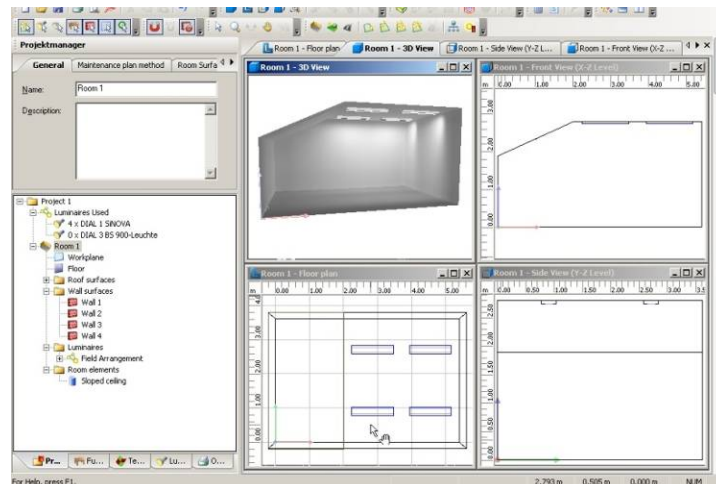

Fig. 262 Working in various views

If your monitor is big enough, it is advisable to keep several views open simultaneously.

The display illustrated above can be achieved by first opening the four views and then arranging the windows, e.g. *Tile Horizontally*.



Fig. 263 Multiple view arrangement

Click on the X icon in the upper right corner to close the window.

Close views via the "X" icon

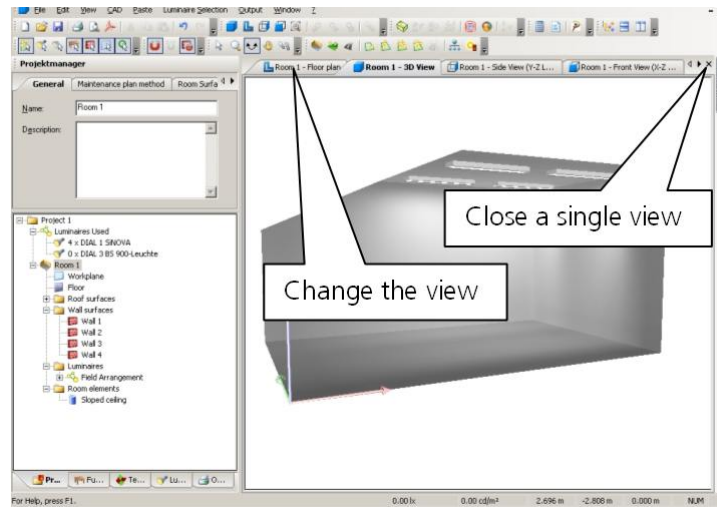

Fig. 264 Closing CAD windows

Save 3D CAD views

Saving of various CAD views (camera mode).

In the 3D view it is possible since DIALux version 4.0 to save camera perspectives of 3D CAD displays with certain key combinations. Turn and zoom the CAD into the required position and then press **CTRL + number**. This view will be saved in the project. The view can be set again automatically by pressing **Alt + number**. The numbers 1 to 10 can be allocated as wished. You can also do this with a right click in the CAD or under the menu "CAD".

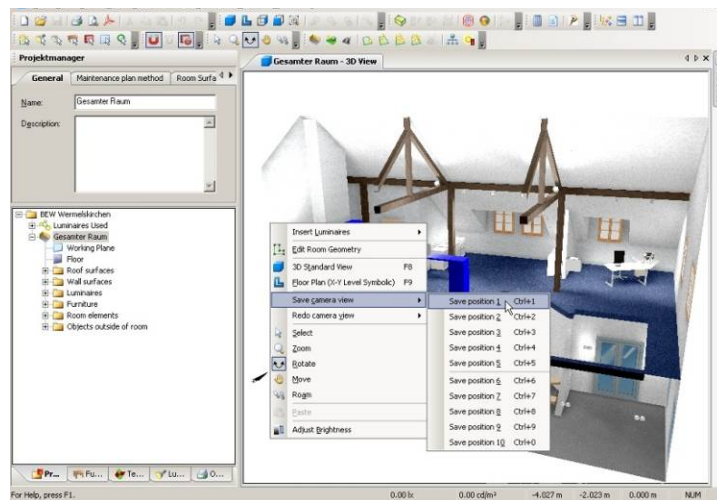

Fig. 265 Save camera view via context menu

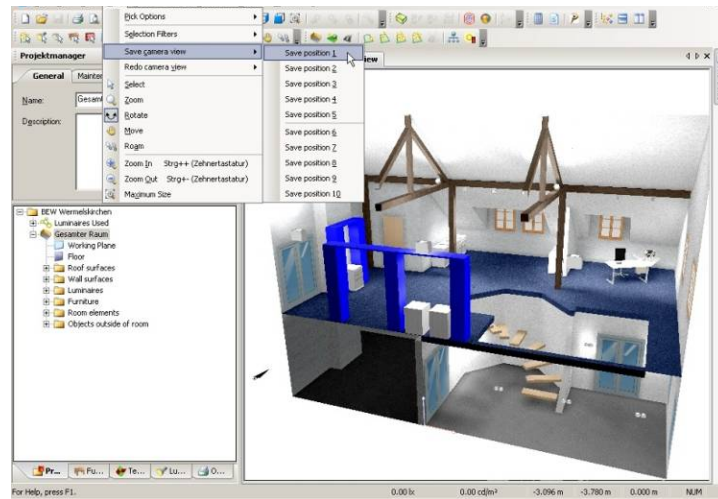

Fig. 266 Save camera view via menu

The function *redo camera view* accesses the saved views. You can proceed via the context menu within the CAD view or in the menu → CAD.

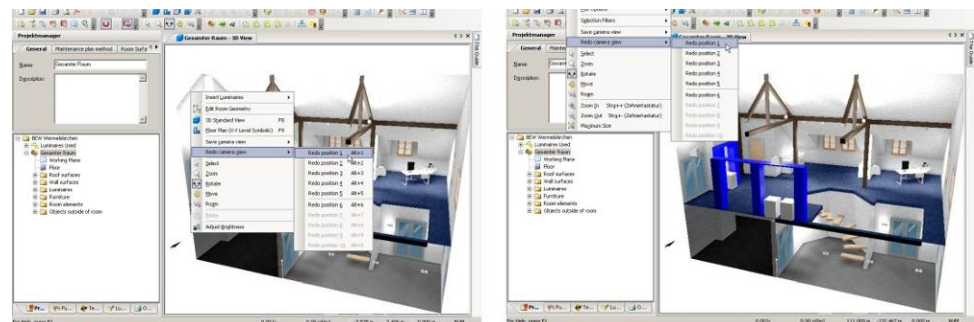

Fig. 267 Redo camera view – Redo positions

Wireframe Model

With DIALux there is the option to change into the wireframe mode. This is so that you can work on an "older" computer without judder when moving in the 3D view. You can find the function in the menu *View* → *Wireframe Display*. It is quicker to use the keyboard shortcut *Ctrl + W*.

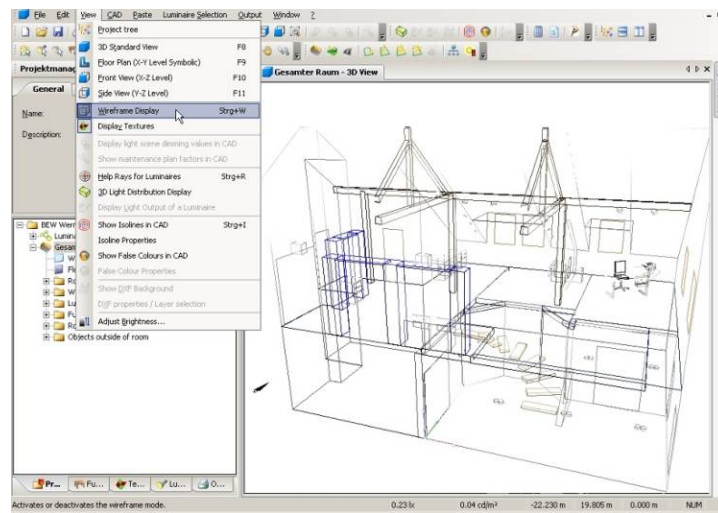

Fig. 268 Changing into the wireframe mode

Editing Inserted Objects

Moving Objects

After luminaires and furniture have been placed inside the room, they can be edited as desired. The *Inspector* displays all information relevant to the object which was selected in the *Project manager* or CAD view. This object can be modified by entering new values. If an object is modified in the CAD view (rotated, moved or scaled) the values in the *Inspector* are updated.

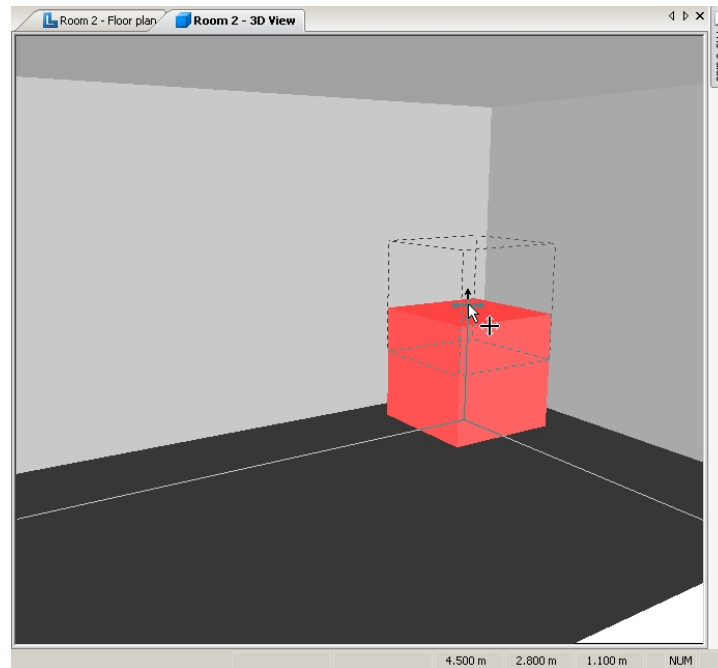
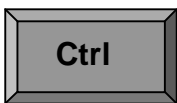

Fig. 269 Graphically modifying the object height

To change the height of an object via the mouse, keep the Ctrl button pressed!



To modify the position of a body along the Z-axis, press the control (Ctrl) key. Keep the button pressed while you click on the arrow cross within the body. As long as the left mouse button and the Ctrl key are pressed, only the height of the object can be modified. When you release the Ctrl key, you can modify the X and Y positions.

In the 3D view, the point of intersection of the three positioning lines shows the position of the cross, projected onto the floor surface.

In DIALux 4.9 it is also possible to move an object not only by its insertion point but also by dragging the corners of the bounding box. The benefit is that it is now easy to place one object directly next to another one and the object automatically rotates itself to get the same rotation as the adjoining object.

To change the working area in the 3D view press the spacebar while the left mouse button is pressed and the mouse icon is above the area you would like the working area to be.

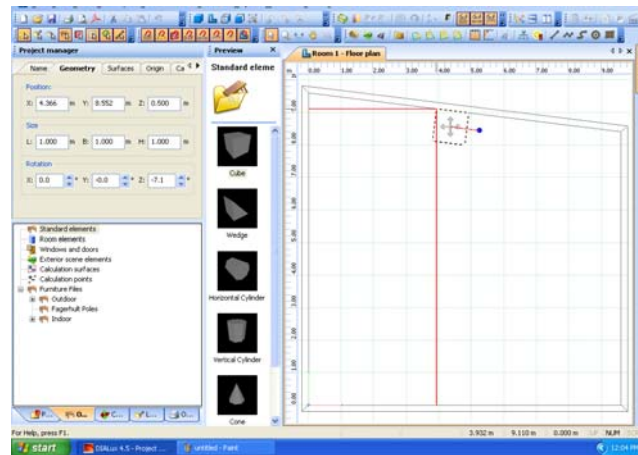

Fig. 270 Dragging an object by its corners and automatic rotation

In the 3D view using any surface as a working surface an object can be moved by the mouse. The working surface is fixed as a parallel surface to the X-Y area (normally parallel to the floor). This can temporarily be changed if the SPACEBAR is hit while the mouse together with the left mouse button is pressed. Example: You click (left) on a cube and move it towards a wall. Make sure that the mouse icon is in front of the wall. Now hit the space bar on the keyboard. The wall will become the working area of the cube now. Instead of moving to the left and to the right (X-Y axis) you can now move up and down (axis of the wall). It can be any other surface as well (tilted floor, furniture,..). The working area is reset when the left mouse button is released and another object is selected.

Fading out objects

Objects can fade out via *context menu*. For this, you have to mark the objects in the *CAD view* or *project manager*. After the marking you open the *context menu* with right-click in the *CAD view*. By clicking on "*selection hidden*" the selected objects fade out.

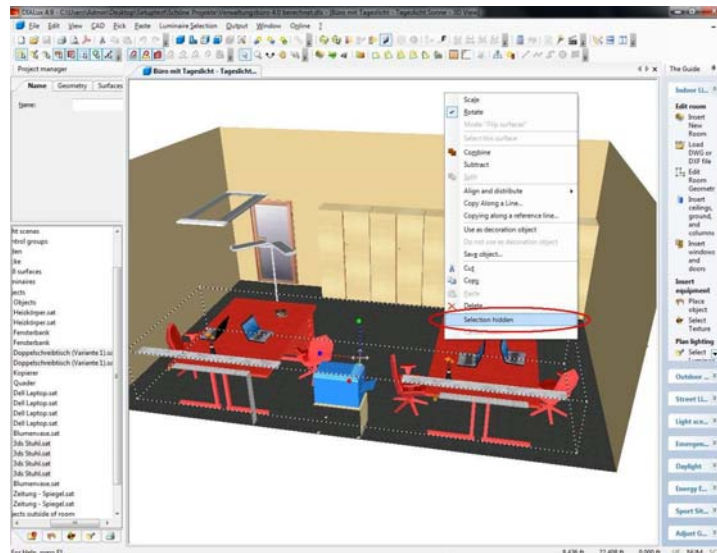

Fig. 271 Fading out objects

Fading in the hidden objects again, you have to open the menu via right-click in the CAD View and choose "Cancel hidden".

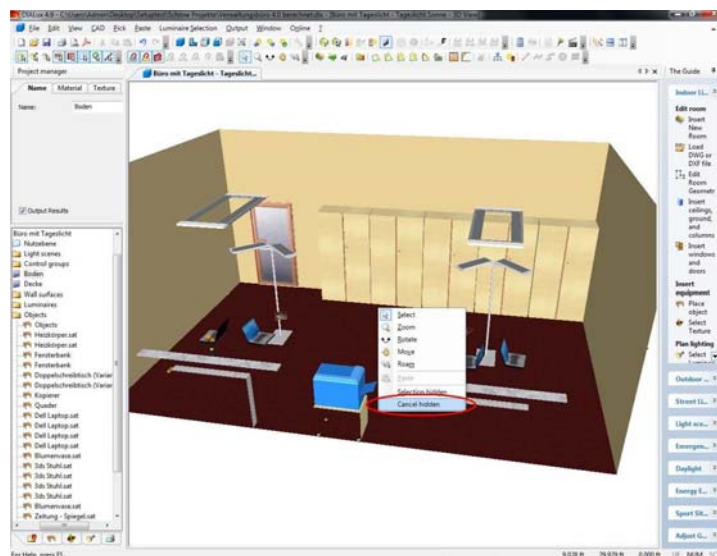
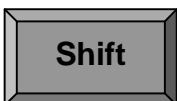

Fig. 272 Fading in objects

To deactivate the preset pick grid, press the shift button!



Moving and Rotating Objects without Pick Grid

When you move the object via the mouse, it only moves within the preset pick grid. If you press the Shift key while you move the object, the pick grid is deactivated. The grid settings to be used when the pick is deactivated can also be preset. Select CAD → Pick Options → Set Pick Grid.

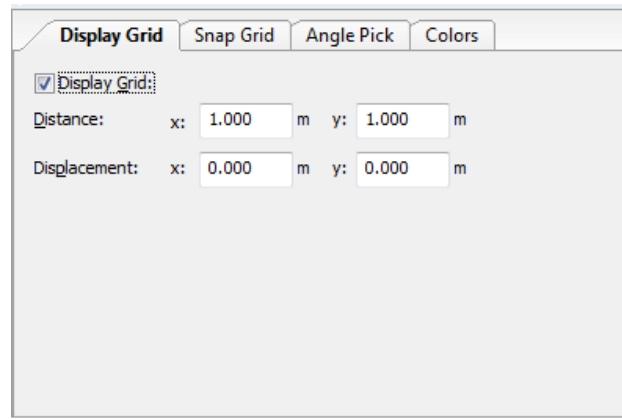

Fig. 273 Pick grid settings – Display Grid

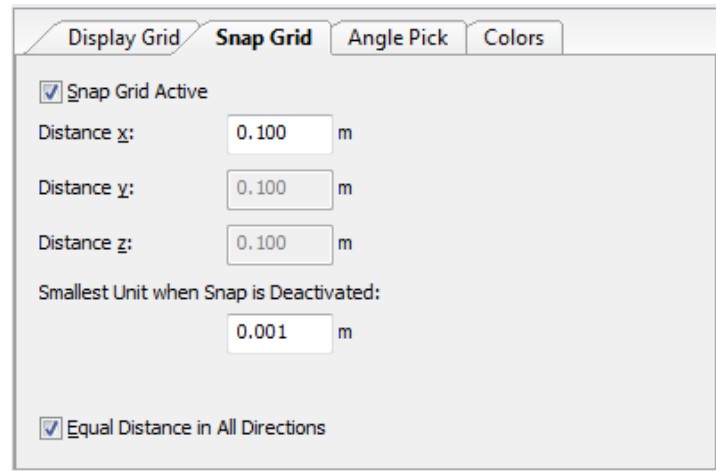

Fig. 274 Pick grid settings – Snap Grid

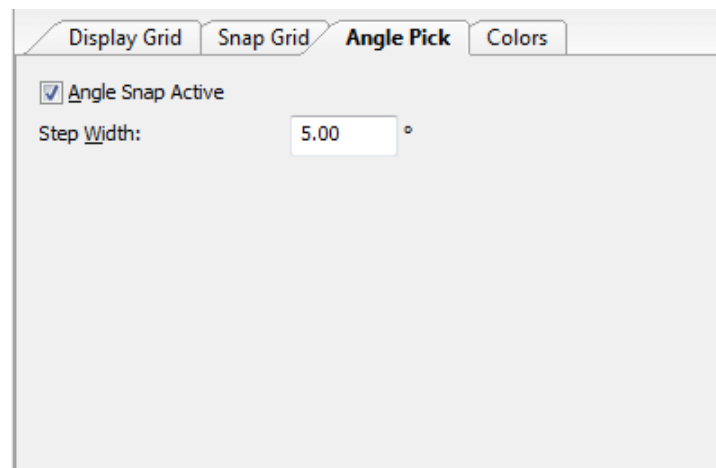

Fig. 275 Pick grid settings – Angle Pick

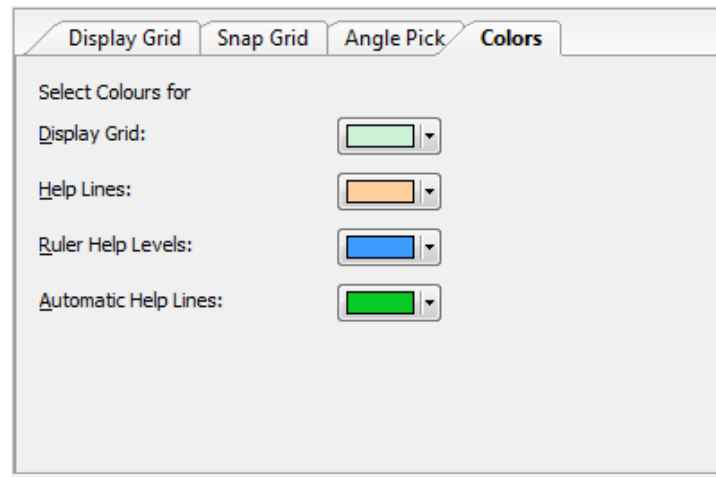
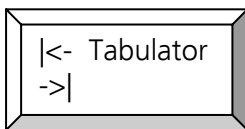

Fig. 276 Pick grid settings – Colours of the Pick grids

Scale or rotate

An object is either in scale or in rotate mode. After selecting an object it is initially in rotate mode. To change between the two modes you can either open the context menu by doing a right click or, and this is new, you can hit the tabulator key to change between these modes.



Rotating Objects

If objects are to be rotated, they must be selected first. Then they can be modified numerically in the Property Page or graphically in the CAD view. Click on one of the three axes rotation points. There is a pick grid for rotations as well (Angle Pick).

Please note:

The **red rotation point** enables a rotation around the **red axis**, likewise the **blue** and the **green** rotation points enable rotations around the **blue** and **green** axes respectively.

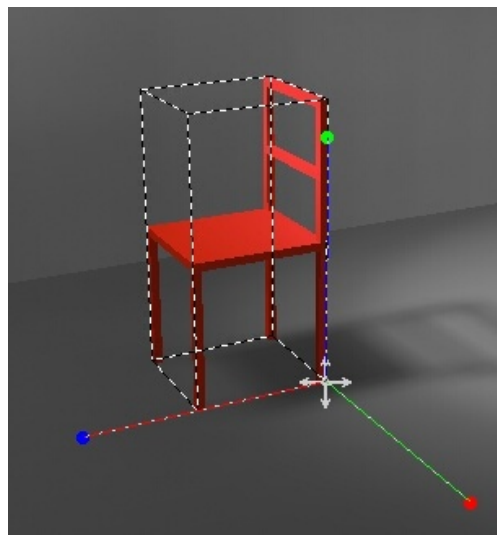

Fig. 277 Rotating objects

Objects are rotated around their own coordinate origin. This is indicated by the arrow cross and by the point of intersection of the three axes. If multiple objects are selected to be rotated together, they are rotated around the centre of the encompassing cube.

Scaling Objects

Objects can be scaled along one, two or three axes. This can be done either in the Property Pages or in the CAD. To go to the scale mode in the CAD, open the object's context menu (right-click) and select the *Scale* option.

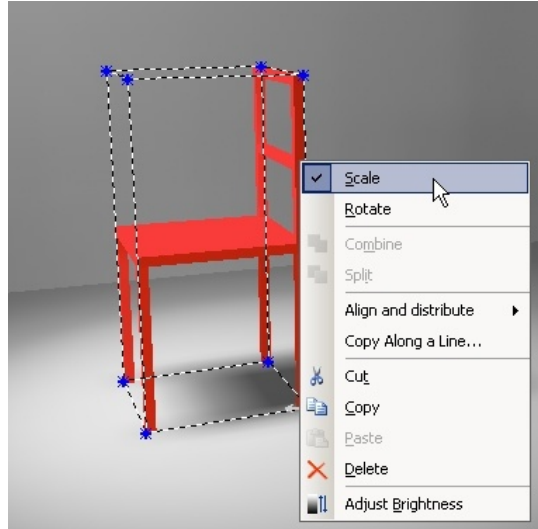

Fig. 278 Object context menu

In the 3D View:
Pull rubber band lines =
Scale in one dimension

Pull rubber band corners
= Scale in three
dimensions

In the 3D view you can scale the object in the X, Y or Z direction by clicking and pulling one of the rubber band lines of the selected object. However, if you click on one of the selected corner points, you simultaneously scale in all directions.

In 2D views you can only scale in one dimension.

Combining and Saving Objects

If you have inserted multiple objects in the CAD which together you wish to treat as an arrangement or to save as a new custom piece of furniture, it is recommended to combine these objects in advance. Objects need not touch to be combined. They can also be positioned independently in the room.

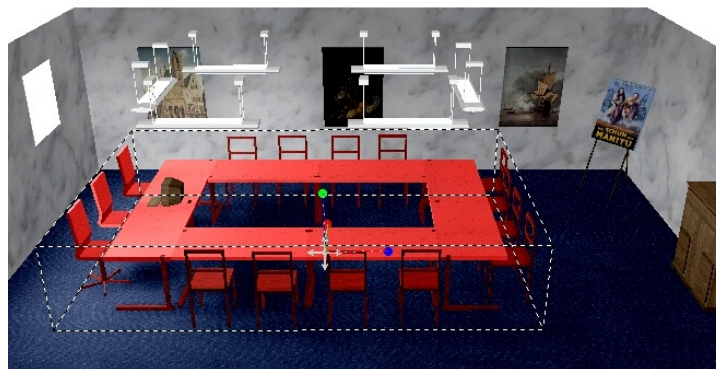

Fig. 279 Combining Objects

To combine objects, select them and select *Combine* from the context menu.

To save objects, select them and select *Save as...* from the context menu.

Important! DIALux only loads furniture saved in the `...\DIALux\Furniture\...` directory into the furniture tree. The user can create subdirectories beneath the Furniture directory. If you have received furniture files in the SAT file format (*.SAT) from the manufacturers, you can save these in the Furniture directory and use them in DIALux.

(See also page 82)

Moving the Coordinate Origin of an Object

If you combine multiple objects, the centre of the encompassing cube automatically becomes the coordinate origin. This is not always the preferred position, because when you insert an object into your project via Drag & Drop, the origin is placed at the height $Z = 0$. Before you save a new object, you should check and position the origin. You can do this in the *Inspector* when you go to the Property Page *Origin*.

To move the coordinates system of an object, press the *Alt* button!

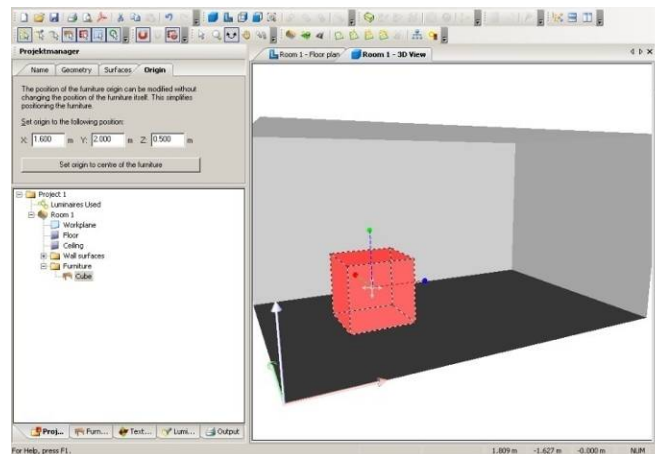

Fig. 280 Specify the coordinate origin

To define the origin visually, press the *Alt* button. When you now move the object's coordinate cross, the coordinate origin is moved instead of the object itself. To change the height or to deactivate the pick grid when movements are made, use the *Shift* and *Ctrl* buttons. If you now save the object, the new coordinate origin is also saved.

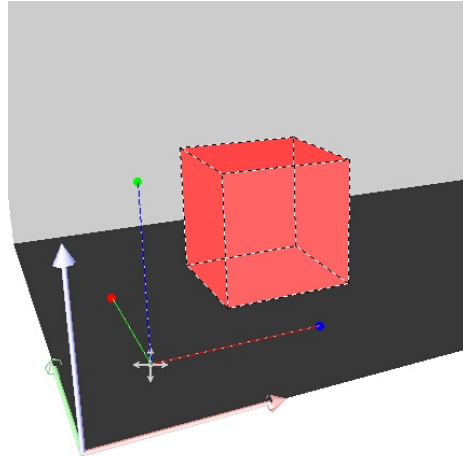

Fig. 281 Coordinate origin which was moved outside the cube

Resetting the rotation of the origin

To create complex models from several simple ones, sometimes it is necessary and useful to reset the rotation of an object. To achieve that, you have to click the "Reset rotation of origin" button in the Origin Property Page of the Object. The length, width and height of the object are taken from the rotated bounding box.

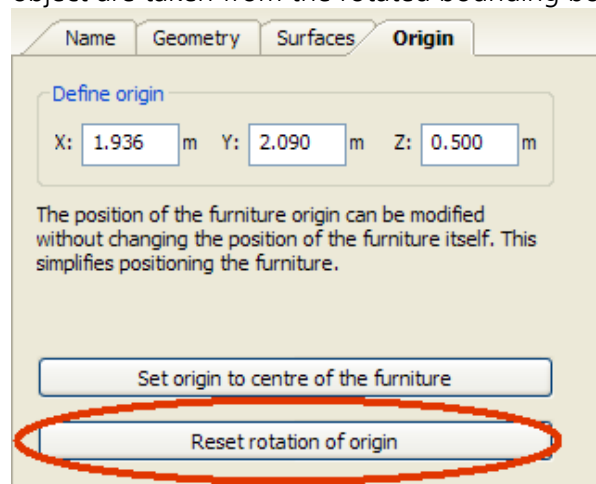

Fig. 282 Resetting the rotation of the origin of an object or furniture

Editing Object Surfaces

In DIALux you can assign any colour, reflectance, material and calculating grid and textures to any surface. To edit object surfaces, select the object and click the *Surfaces* tab.

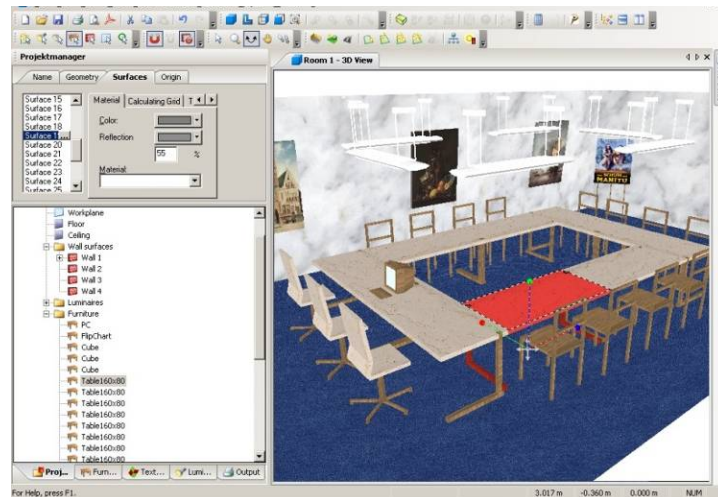
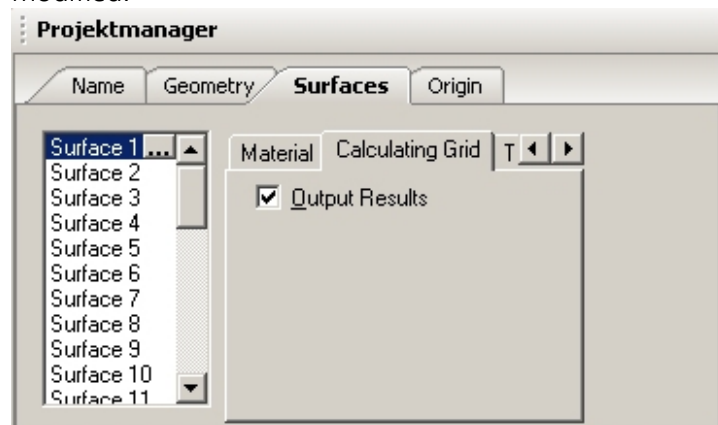

Fig. 283 Editing surfaces

In the *Inspector*, the Property Page with a list of existing surfaces appears. If you select a surface (surface 1 in this case), this is highlighted with a rubber band line in the CAD. In the right-hand side of the Property Page you can select a material, a reflectance or a colour. By clicking on the empty field "... " behind the name of the surface in the listbox on the left-hand side, the name can also be modified.



To receive output on furniture surfaces, check the *Result Output* checkbox.

Fig. 284 Calculating grid and furniture surface output

To include the calculation results of a certain surface in the output, please check the *Output Result* checkbox in the *Calculating Grid* tab.

Time and again it is necessary to work on single surfaces of an object. With complex objects with very many surfaces, it may take a lot of time to find the required surface in the surface list of the object's Property Page. To make this simple you can now select a single surface graphically. Just right click the object on the required surface in the CAD and choose "Select this surface" from the context menu. The required surface is selected in the Property Page and it can be assigned a colour, a texture, material and so on.

If Output Results is checked the surface selected appears in the project tree of the project manager. It may be helpful to rename this surface in the project tree so that results are easily identified.

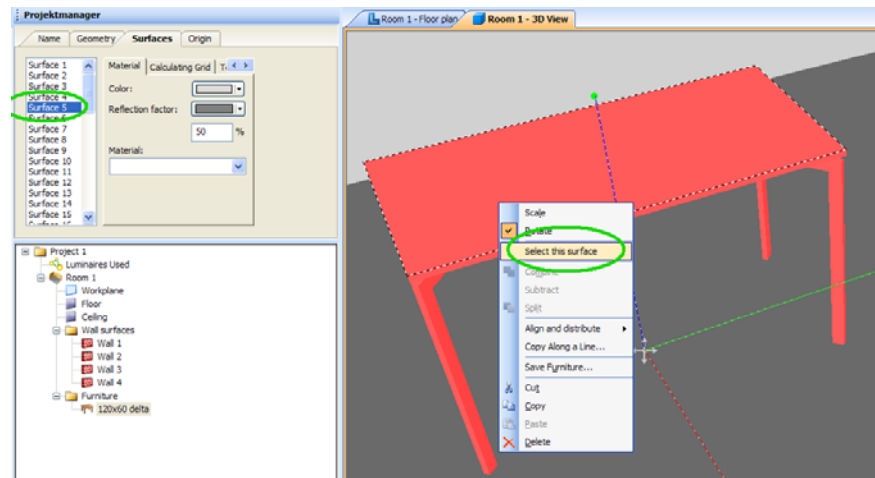

Fig. 285 Selecting a single surface with the mouse

Arrangement aids

Measurement of distances

Using the tape measure it is easily possible to find the exact distances between objects in 2D and 3D view. To start the tape measure just click on the icon or select the tape measure in the menu CAD.



Fig. 286 The tape measure icon

In the 2D view, the tape measure is placed by clicking on two points in the CAD window. The end points of the tape measure will snap to grids, help lines, insertion points of objects and to the bounding box of objects. If the snap is not to that point you like it to be, just zoom into the scene and the snap will be more accurate.

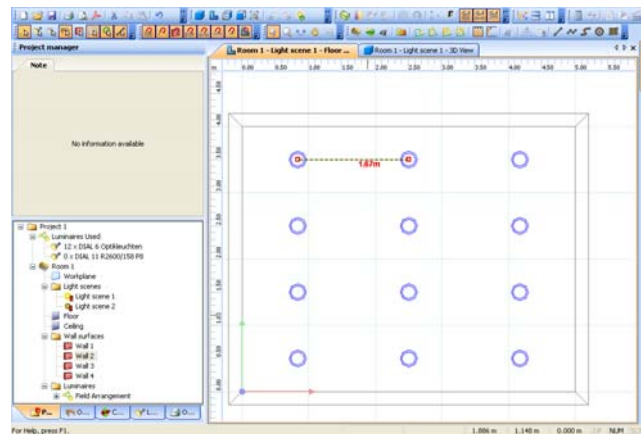

Fig. 287 The tape measure function in the ground plan view

In the 3D view, there are even more distances visible. There you can see the direct distance between two points as well as their heights above the floor and the distance on floor level.

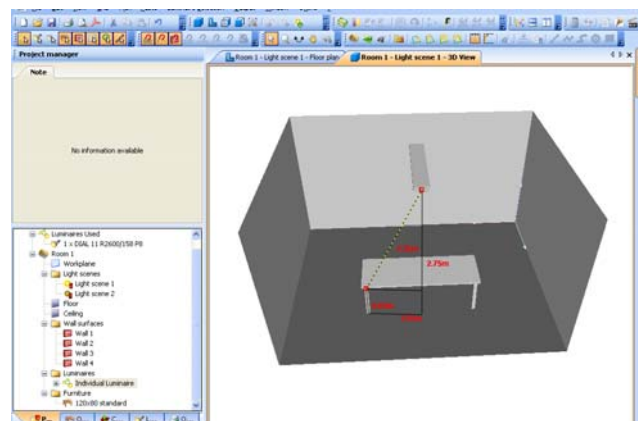

Fig. 288 The tape measure function in the 3D view

Working with the snap grid

The snap grid is a tool to simplify the handling and the movement of any object in the CAD views. The objects will step in the distance that's defined in the snap grid settings. The grid distances can be equal in all three directions but can also be different for X, Y and Z.

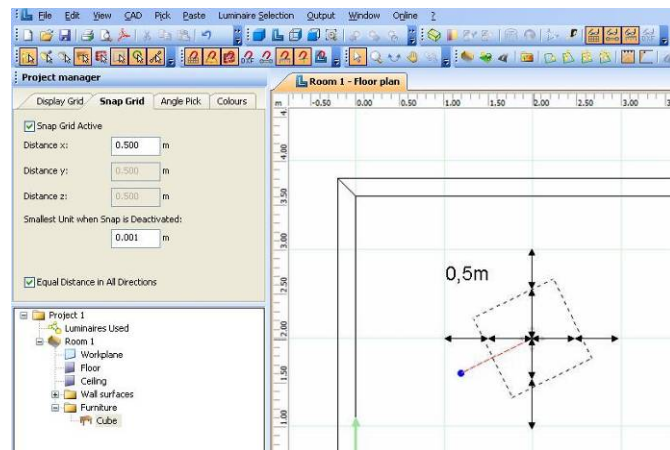

Fig. 289 Fixed grid with a spacing of 0.5m in X and Y direction.

If you want to move an object for a short period without a grid, just hold down the SHIFT key while you place the object. This is valid for all grids and help lines.

To make the snap grid a visible tool as well, use the same settings for the display grid as you do it for the snap grid. The colour can also be changed to have a better contrast for example against a background DWG file.

Automatic help lines

Those objects which are already placed in a room or exterior scene can be used to align other objects. Moving an object you will recognize that in orthogonal direction there is a higher "gravity" than in any other direction. So moving along X, Y or Z axis is simple. Those objects (bounding boxes of furniture, walls, luminaires room elements), which are already in the scene can create automatically temporary help lines to align other objects to.

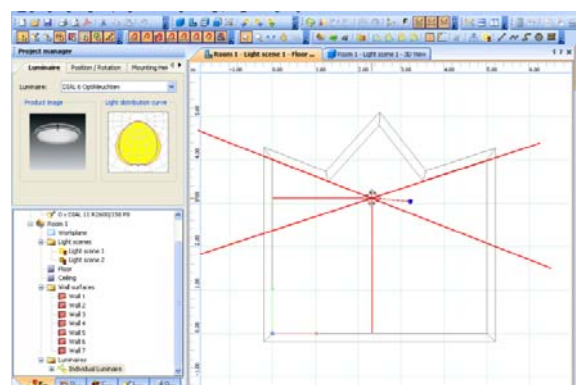

Fig. 290 Automatically by the walls generated temporary help lines.

In the screenshot you can see the red help lines which follow the direction of the tilted walls. These help lines are generated when you move with one object (e.g. luminaries) for a short while above any other object (e.g. wall). The help lines are visible until the left mouse button is released.

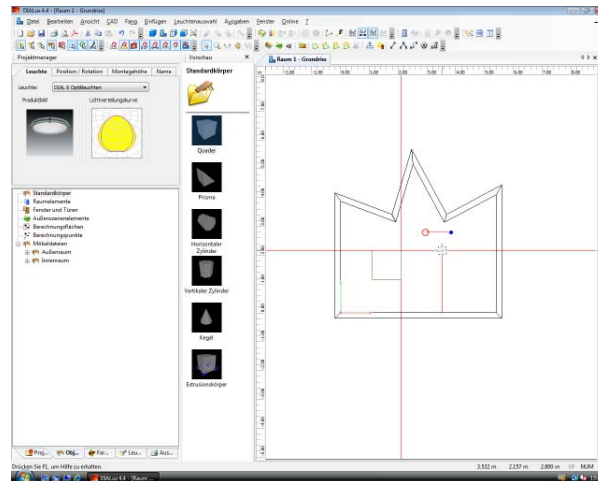

Fig. 291 Automatically by an object generated temporary help lines.

Here you can see help lines generated by the cube. Now it is pretty easy to align cube and luminary.

Helping areas defined in the ruler

In ground plan, front and side view there are rulers located on the left and on the top of the CAD window. This ruler will show you the mouse position in X-Y, X-Z and Y-Z direction. From this ruler you can generate helping areas which are defined in a specific position and are useful to align objects to.

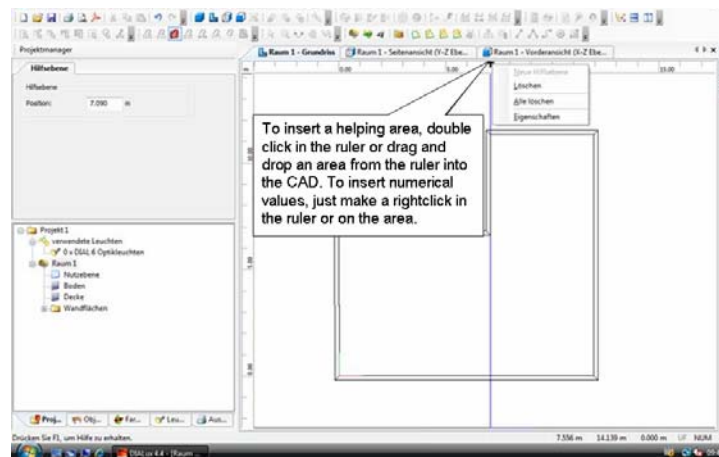

Fig. 292 Creating helping areas in the ruler

You can create those helping areas by double clicking in the position of the ruler or drag and drop the helping area from the ruler into the CAD. It is called helping area because it is active in two dimensions. If you place a helping area in the ground plan view parallel two the X-axis, it will be available in the side view as a parallel line

facing from top to bottom as well. If you place a helping area parallel to the Y axis, it will be visible in the front view. Having them available in two views makes it easy to place objects not only in a desired position but also in a correct height.

If there are already objects in the CAD window available, the helping areas can be snapped to those objects as well.

Working with help lines

Help lines are objects which can be placed in any 2D view. When they are placed in the ground plan view, they are only visible in this view, not in any other 2D or 3D view.

They are meant to align objects to them or to place objects on them. Moving an object towards a help line, the snap will work on the bounding box and on the objects origin. If an object is moved with the mouse on the bounding box dragger also the rotation of the object is align to follow the help line. This will not happen, if the object is dragged by its origin.

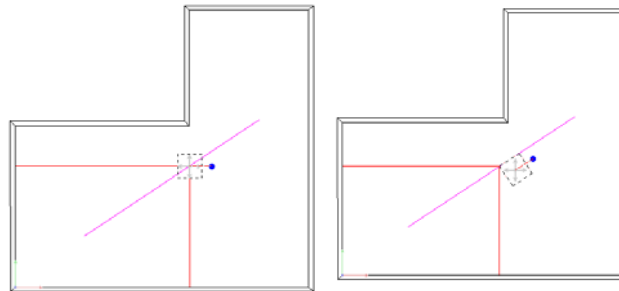

Fig. 293 In the left sketch the object is moved on its origin, on the right it is moved on the bounding box. In the second case the rotation is adjusted.

Help lines are not printed out. To insert a help line just press the icon or use the command "Insert" -> "Help lines".



Fig. 294 Icons to insert help lines

After selecting a help line, you can continue to edit this in the room with the aid of the context menu. The functions available include "Delete last point" as well as cancelling the help line. Just place a help line in the room and open the context menu with the right mouse

button.

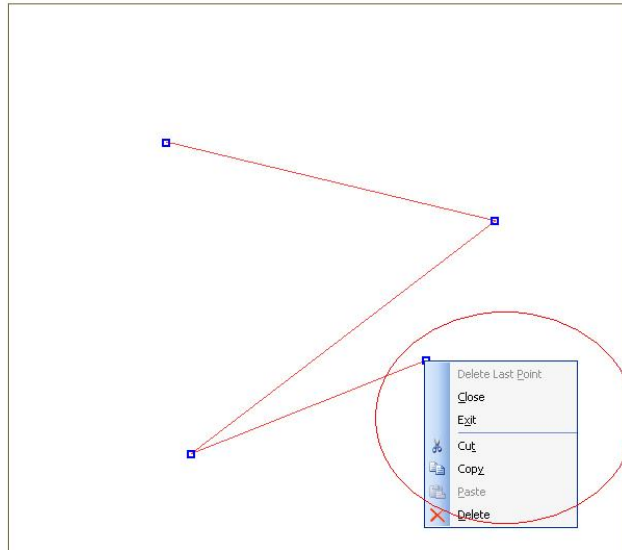

Fig. 295 Further editing of a help line

Simple help lines

The simple help line is useful to align objects. Moving an object towards the help line it will be automatically snapped on the help line when a specific distance is reached. To avoid the snap temporarily just hold down the SHIFT key. To avoid the snap continuously, switch of the icon for the help line snap.



Fig. 296 Icons to switch on and off the snap to help lines

A help line is defined by clicking for the starting position and again clicking for the end position.

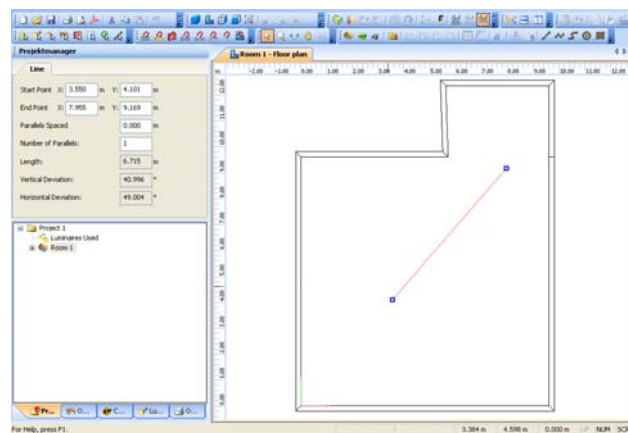

Fig. 297 Inserting a help line

In the inspector you can see the numeric values of start and end point. Further on you can see the angle the help line is rotated compared to the horizontal and the

vertical axis of the 2D view. That's way the axes changes from ground to side views.

The possibility to create parallel lines is also very useful. Just enter the number of parallel lines you need and the distance they should have.

To delete help lines just select and press the del(ete) key or select delete from the context menu. Help lines can be selected to be displayed or not. To switch between this modes press the glasses icon with the help line on it.



Fig. 298 Display help lines

Poly help lines

A poly line is working like a simple help line but instead of defining just a start and end point there can be any number of vertices in between. The line between vertices is always straight forward. Each left click defines a new vertex. To stop the poly line mode press the ESCAPE key or make a right click. In the context menu you can choose between closing the line between first and last point or just stop the mode at the last vertex.

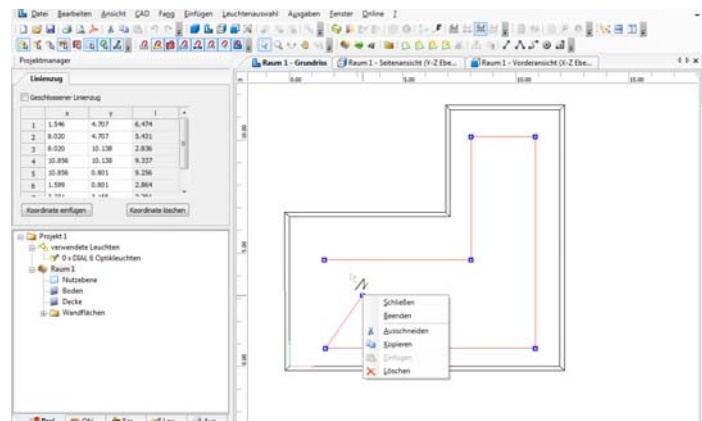

Fig. 299 Insert a poly line, stop the mode with a right click

In the inspector each vertex can be changed numerically and by ticking the checkbox the poly line can be closed.

To move the complete poly line after it is defined once, hold down the ALT key while the mouse is above one vertex and holding down the left mouse button.

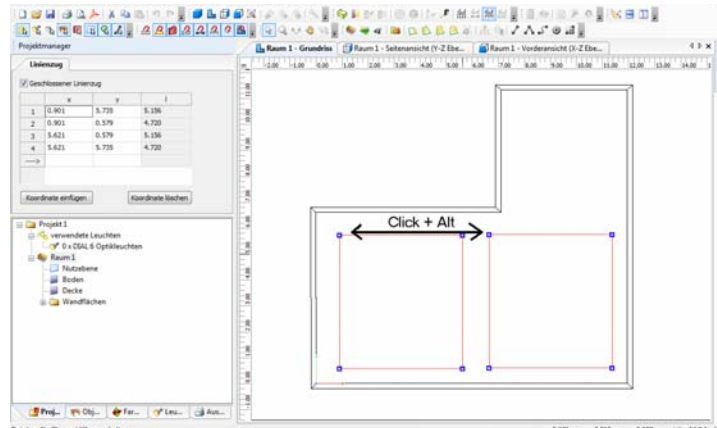

Fig. 300 Move the complete poly line by holding down the ALT key

Spline help line

The spline help line can be placed like the poly help line. The lines between the vertices are not straight but curved to follow a smooth line between the vertices. In the start and end point there are draggers which can be used to change the line towards the start and end point.

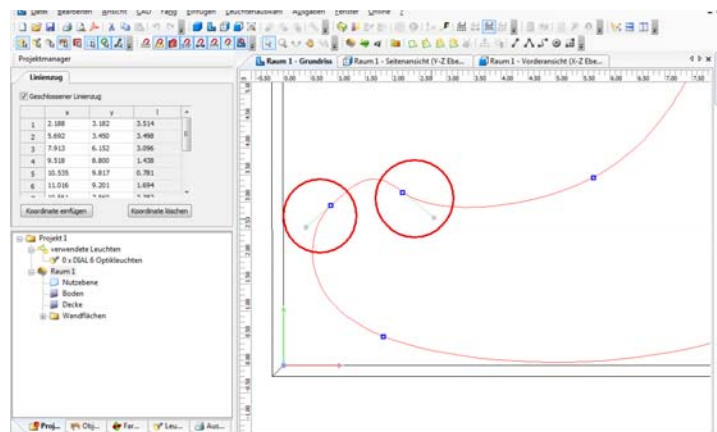

Fig. 301 A closed spline help line. In the start and end point are draggers to change the line

To move the complete spline help line after it is defined once, hold down the ALT key while the mouse is above one vertex and holding down the left mouse button.

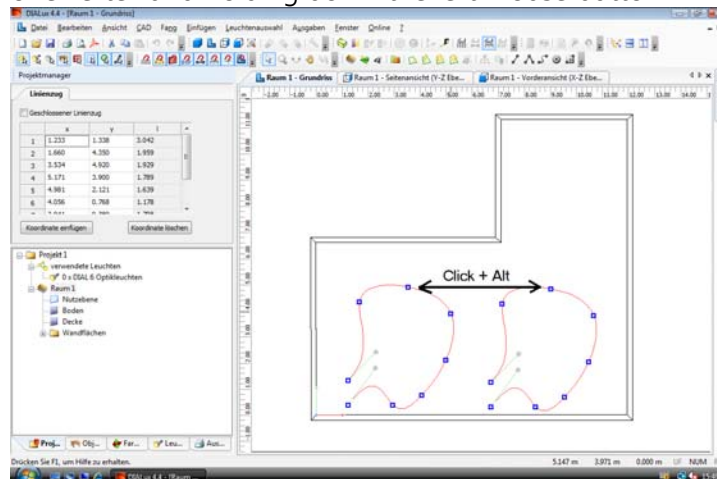

Fig. 302 Move the complete poly line by holding down the ALT key

Circular help line

The circular help line can be placed by first defining the mid point and then the radius.

Copy along a help line

Any help line can be used to be the copy and paste path of any object. Any object and any object combination can be copied along a help line, e.g. furniture, luminaries, Calc surface + furniture... To start that function, the help line has to be available in the scene. The object that has to be copied along a help line has to be in the scene as well. If you want to copy combined objects, you have to place them correctly next to each other first. The position in the room/exterior scene does not matter at all.

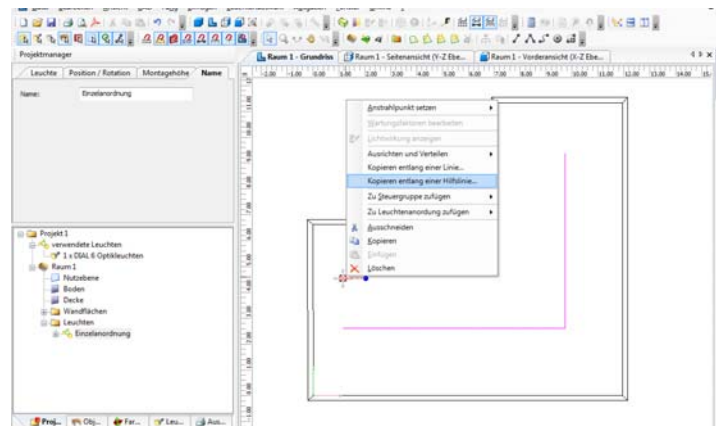

Fig. 303 Copy along a help line with the mouse

Start with selecting the object to be copied. Then make a right click and select "Copy along a help line" from the context menu. Now there is a symbol at the mouse to select the desired help line that should be used as a path where the object should be copied along. When the mouse is above a help line a small hook appears that tells you that this help line can be selected. The line is selected with a left click.



Fig. 304 Mouse symbol to select a help line for copying

Once the desired help line is selected, the inspector offers the possibility to define the desired number of copies and the distance between them.

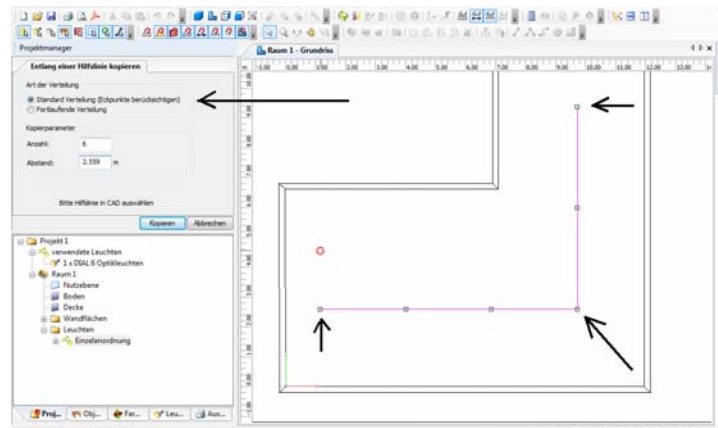

Fig. 305 Copying in the standard setting with placing objects in the vertex

If the standard setting is selected, DIALux places the first object in the start point, the last one in the end point and in every vertex also a copy. The distance between objects placed within two vertices will be averaged to keep the number of objects and the resulting distance close to the desired values in the inspector.

If the second setting is selected, the distance between the objects is fixed. The first object is placed in the start point and every following one has the exact distance as defined. If the length of the help line is not integer literal of the distance, the complete length is not used and a rest of the line remains.

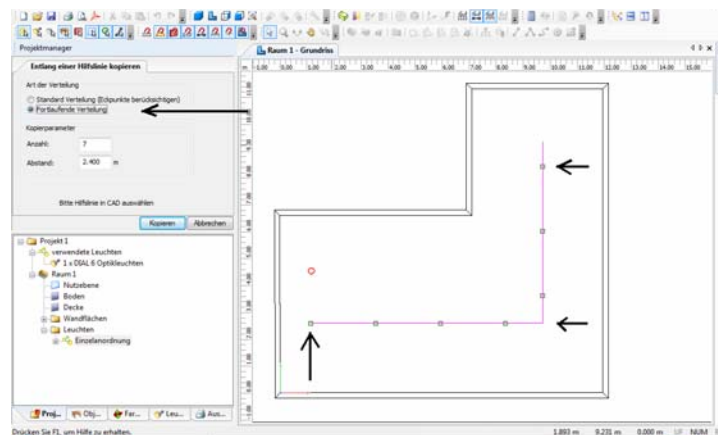

Fig. 306 Copying along a help line with fixed distance

In this way it is also possible to copy objects along spline help lines and circular help lines.

Help grids

In addition to the help lines it is also possible to insert help grids into the scene. To start this action, click on the insert help grid icon.



Fig. 307 Insert a help grid

In the inspector start and end point as well as the grid angle and the grid distance can be adjusted. In the graphical way, first the start point has to be defined with the first click. The second click defines the position of the end of the first axis of the grid. The third click has to be made in a distance perpendicular to the second point to define the width of the grid area. Initially the grid distance is set to 0.625m. This value can be changed in the inspector or graphically by moving the dragger next to the start point.

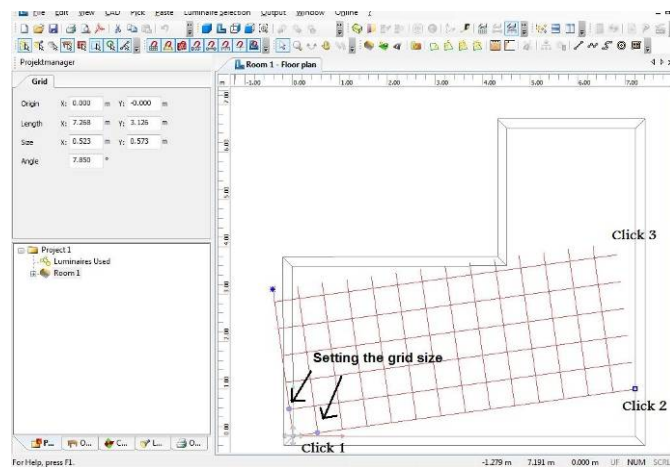

Fig. 308 Defining a help grid

The grid has snap points on each edge, on the lines at half the grid length and in the middle of each grid element.

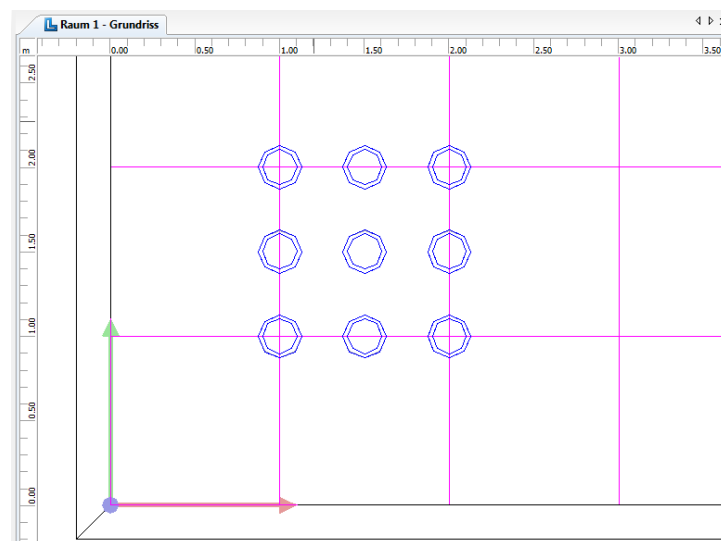

Fig. 309 Snap points on the help

Of course it is possible to place grids in other grids. This is useful if a luminaire arrangement should be placed within one ceiling element.

Copy and paste with CTRL+C, CTRL+V and CTRL+H

With CTRL+C objects can be copied into the clipboard. This can be single objects or combined objects even those ones of different types. With CTRL+V the copied objects will be placed next to the original objects in a distance of 1m in X and 1m in Y direction. With the keyboard shortcut CTRL+H the object in the clipboard will be pasted next to the position of the mouse, taking into snap of any snap grid nearby. To copy luminaires into a ceiling grid just place the first fixture. Then move the mouse to the ceiling panels you need a luminaire in and press the CTRL+H keys. The luminaire is pasted and (if the mouse was close enough) the grid snap takes the luminaire in the correct position.

Copy Along a Line

DIALux offers the possibility to copy an object repeatedly one behind the other. This function *Copy Along a Line* is selected in the CAD window using the right mouse button or the menu *Edit*.

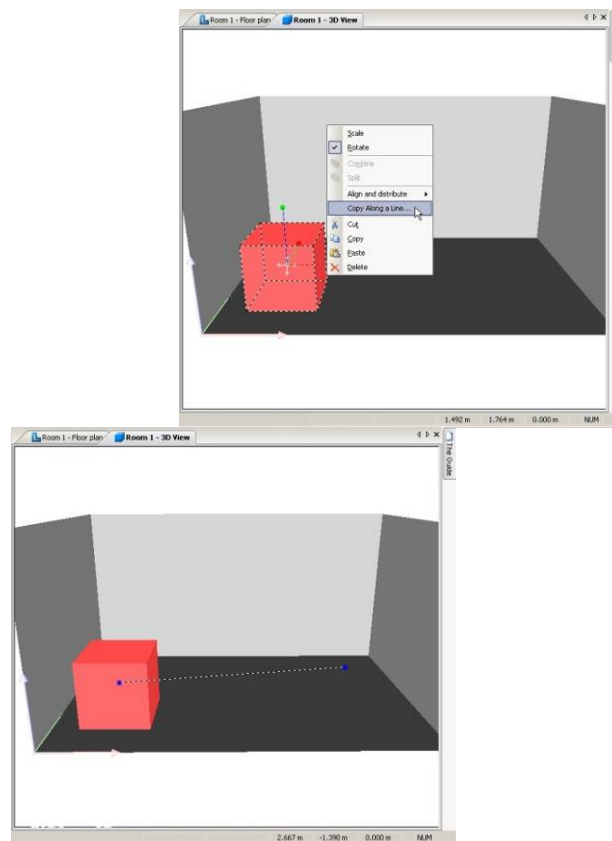

Fig. 310 Copy along a line with the mouse

In the *Inspector*, as an alternative or supplement to using the mouse you can edit the number of copies; align the line, the distance and the position of the last copy.

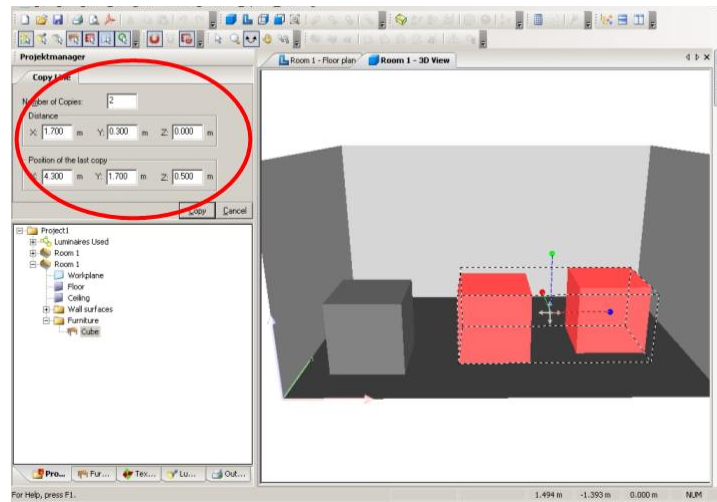

Fig. 311 Copy along a line with the inspector

Align and distribute

It is often necessary when planning and positioning several different objects to achieve a flush surface or to adjust them vertically and horizontally to achieve a regular arrangement or a neat appearance to the ceiling. In DIALux you can edit this in the context menu of the marked objects or in the menu *Edit* → *Align and distribute*.

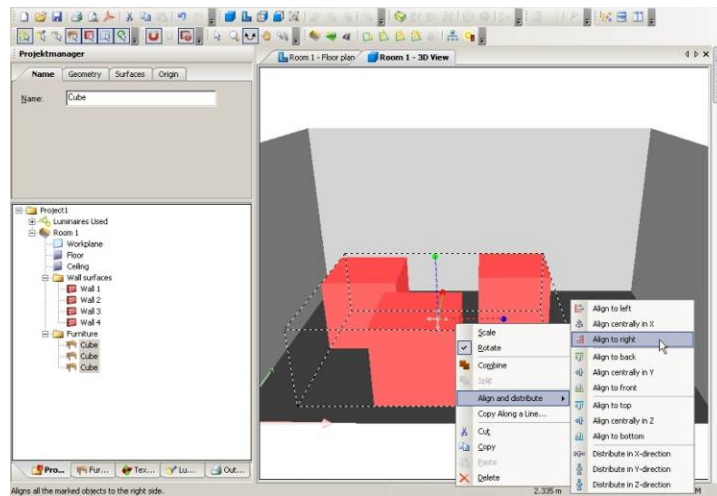

Fig. 312 Context menu CAD – Align and distribute

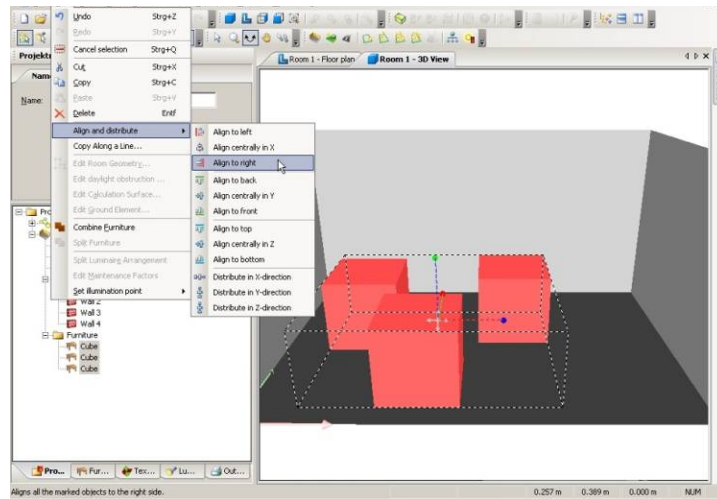

Fig. 313 Menu Edit – Align and distribute

Centre objects in the room

This is a very useful tool to centre luminaires separated by a modular spacing (for example a 600mm ceiling grid) in the middle of a room. The luminaire arrangement will be placed in the middle of the room after defining the number of luminaires and the distance between them.

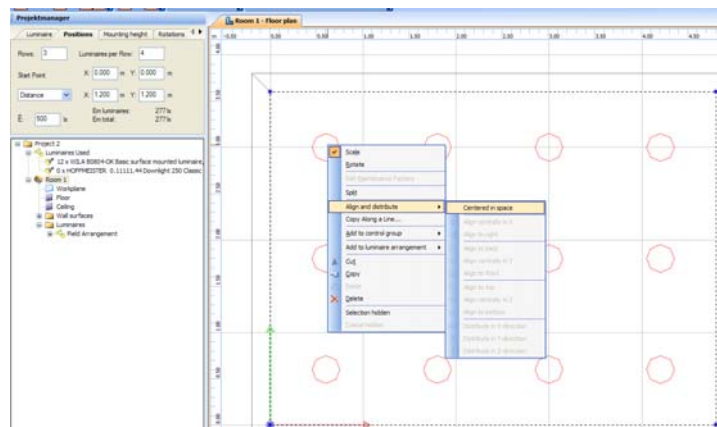

Fig. 314 Align and distribute – centred in space

Calculation Surfaces and other Calculation Objects

In the furniture tree you can insert calculation surfaces or task area in DIALux. To do this simply select *Calculation surfaces* and move the appropriate object via Drag & Drop into a CAD window.

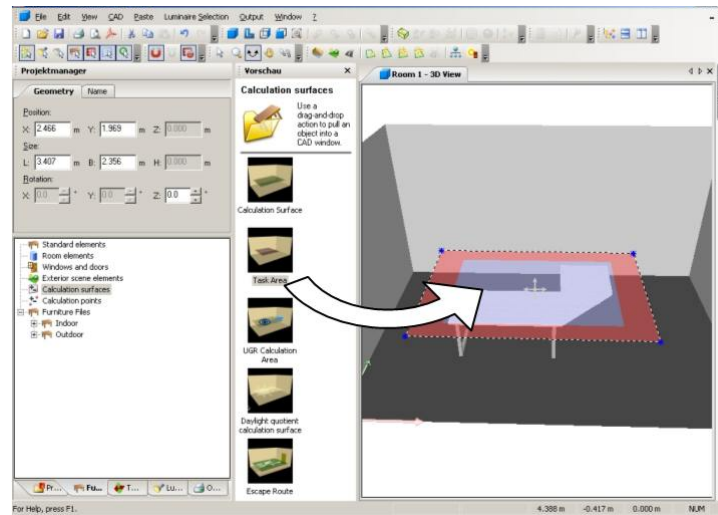

Fig. 315 Inserting calculation surfaces or task areas

Calculation Surfaces

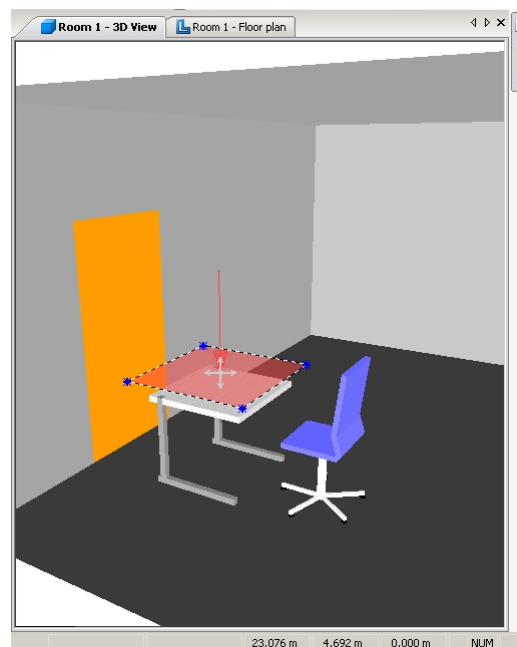

Fig. 316 Transparent calculation surfaces

A calculation surface is an area in which the illuminance can be "measured" without affecting the light distribution themselves. Various calculation surface norms exist, for instance the work plane, the correct reading level for hospitals etc.

A calculation surface is displayed as a transparent surface, as the example shows. The surface which

appears transparent is the surface which provides the calculation results. The surface is invisible when viewed from the other side. No results are calculated for the invisible side.

These objects can be scaled and rotated like all other furniture. Exception: windows and doors are always plane-parallel to the respective wall.

Calculation surfaces for different types of illuminance

The calculation surfaces in DIALux can now calculate different types of illuminance. As well as calculating the normal, namely the planar illuminance, perpendicular to the receiving plane, it is now possible to explicitly calculate vertical planar, horizontal planar and camera directed planar illuminance and also semi-cylindrical and cylindrical illuminance.

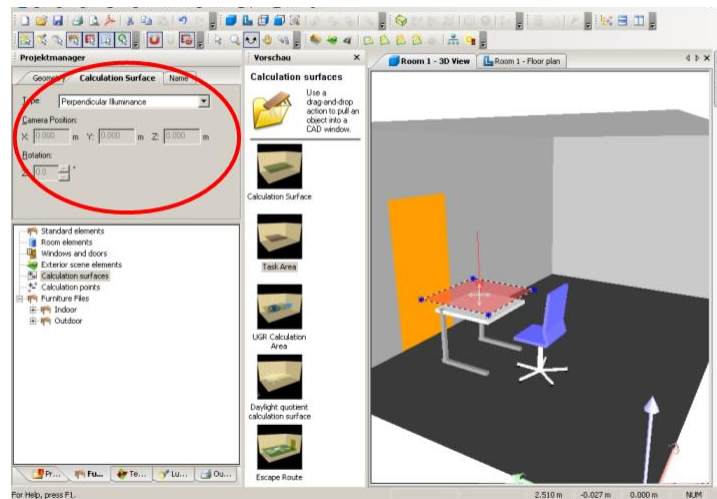

Fig. 317 Different types of illuminance

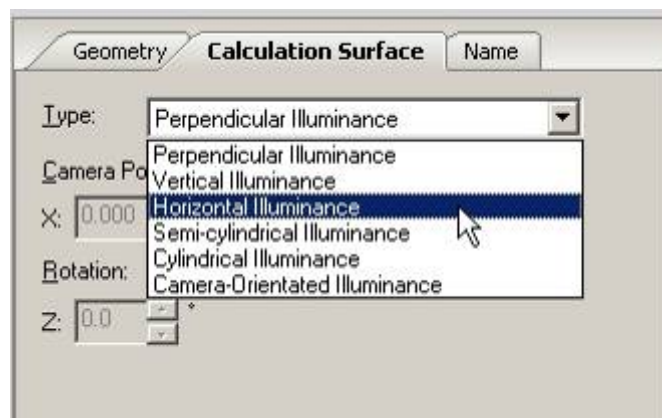

Fig. 318 Property Page of calculation surface – Selection of the types of illuminance

Penetration

If calculation areas are penetrated by furniture (e.g. cupboard and working surface) these are now

automatically “cut out” of the virtual planes with DIALux. It is not necessary for the user to make any special settings.

Task Areas

Task areas are calculation surfaces that consist of two parts. In DIN 5035 T7 and EN 12464 these two parts are defined. The two parts are the inner *Work Area* and the outer *Surrounding Area*. You can edit the polygonal shape of areas by clicking the right mouse button. The two parts are defined in the following way:

- Both areas are plane-parallel.
- The complete task area is positioned within the surrounding area.

The output shows isoline and greyscale diagram for both areas together. Value charts and value tables are listed separately for each area.

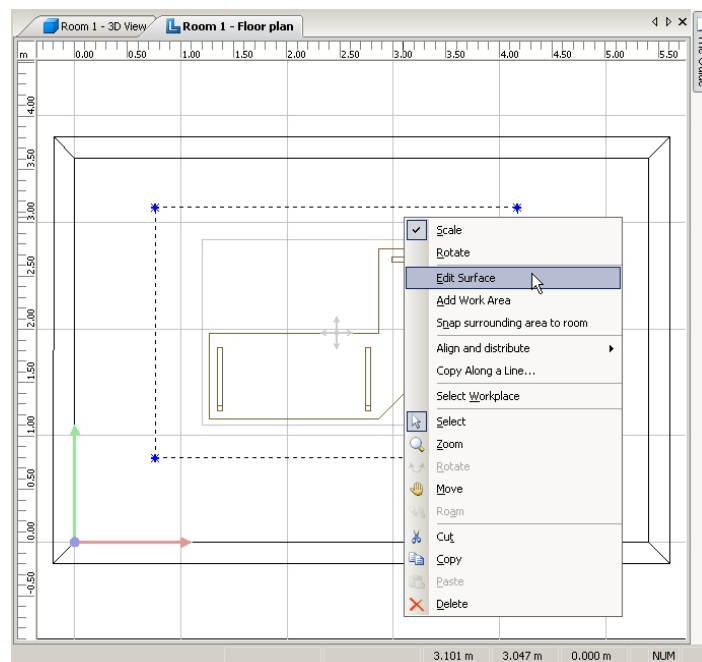

Fig. 319 Edit work area and surrounding area

Calculation grids

With DIALux 4.9 you can insert not only calculation surfaces but also calculation grids. The basic difference from calculation surfaces is the limitation of the number of calculation points. Calculation grids have a great number of associated outputs. All sports complexes have at least one calculation grid. You also have the additional option of inserting additional calculation grids. You will find these either in the project tree under “Objects” or in the menu under “Paste” → “Calculation Grid”.

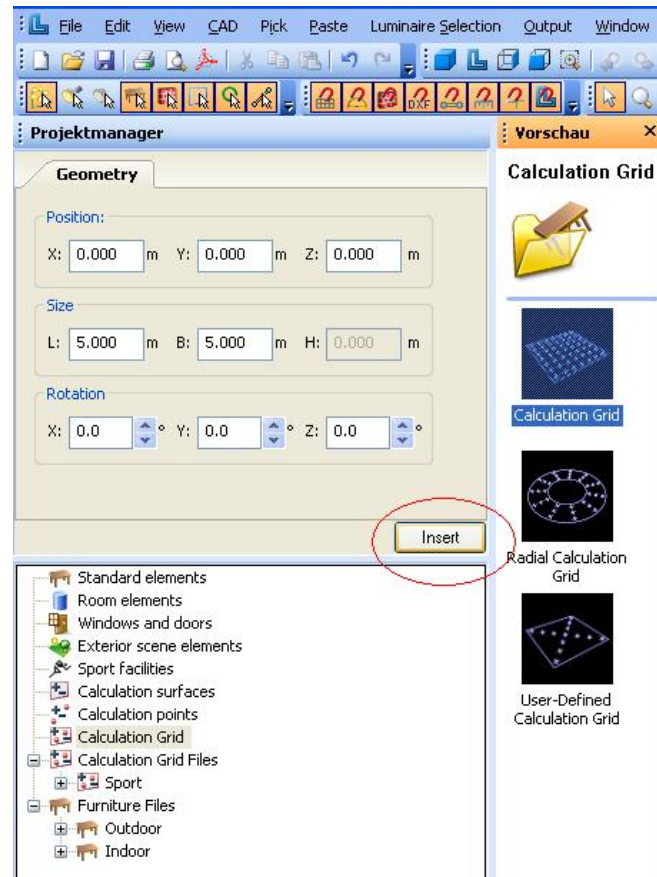

Fig. 320 Inserting a calculation grid via the project manager

By simply using the “drag and drop” function you can now insert a calculation grid. Just select a calculation grid, click on it with the left mouse button and pull it to any position within the project. Alternatively you can define the exact position in the Inspector beforehand and let DIALux position the calculation grid.

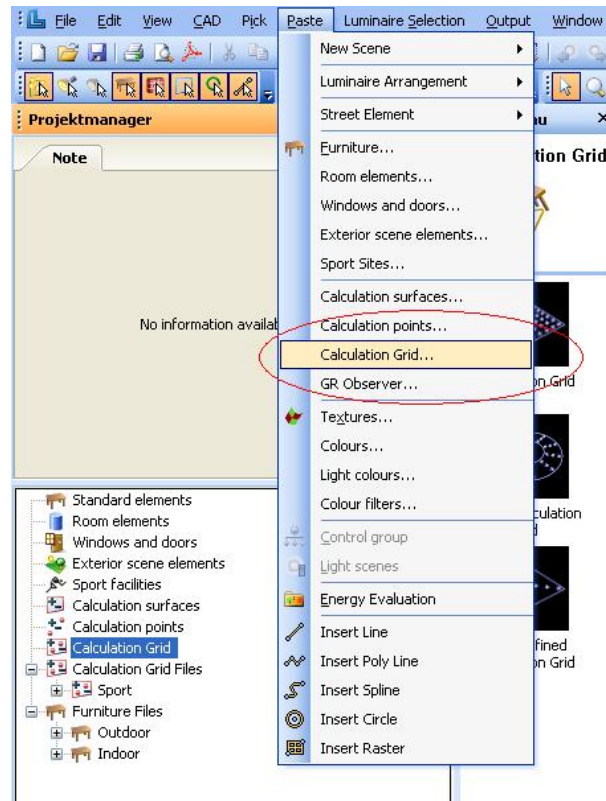

Fig. 321 Inserting a calculation grid via the menu

In total there are three different calculation grids – quadratic, radial or user-defined according to your own parameters.

Calculation Grid

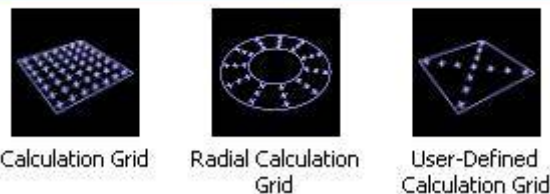

Fig. 322 Types of calculation grids

The quadratic and user-defined calculation grids are conceptually similar (size and shape). However, with the user-defined calculation grid it is possible to change the height of the grid's position of origin and the quantity of calculation points. The radial calculation grid enables individual changes to the internal and external radii and the original coordinates.

Editing

As well as inserting calculation grids, you can also edit them and save them for later projects. Just click with the right mouse button on the calculation grid you have inserted and then, in the context menu which then appears, select the item "Convert for editing". Then right click on the grid and select "Save calculation grid".

Please note: When you do this, all automatic scaling options of the grid will be deactivated.

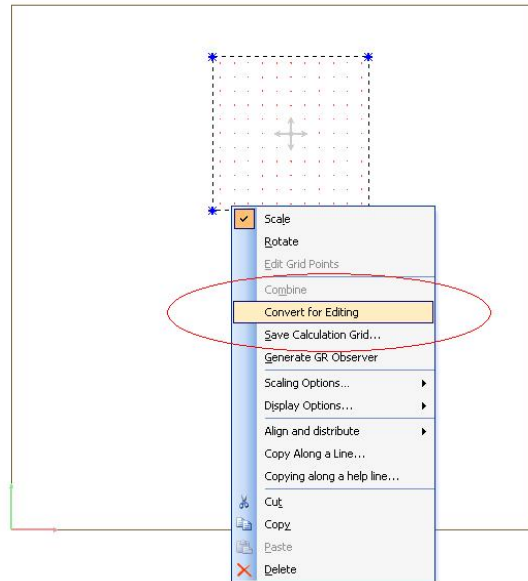

Fig. 323 Converting the calculation grid

Conversely you can then insert additional grid points or change existing points via the context menu under the sub-item "Edit grid points".

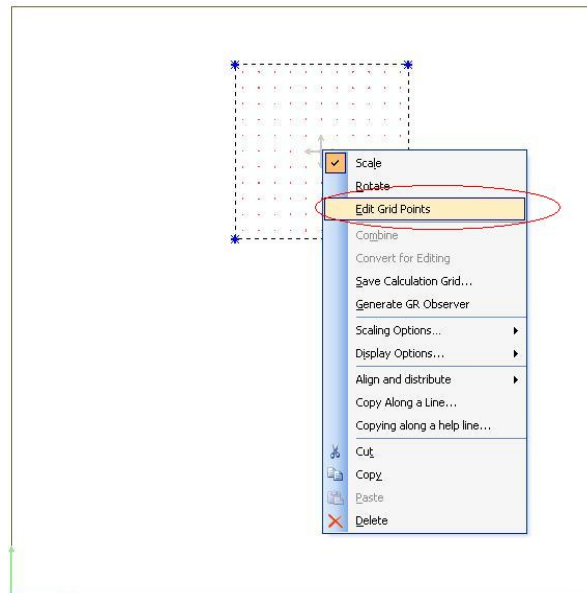

Fig. 324 Editing grid points

You can adapt grid points either via the Inspector (under "Select") by entering the coordinates or directly by moving with the mouse. If you decide on the second of these two options, just click on the respective grid point with the left mouse button and continue to press on the mouse button to move it to the desired position.

It is also possible to change the 'z'-values which means that you can create very complex, three-dimensional calculation grids.

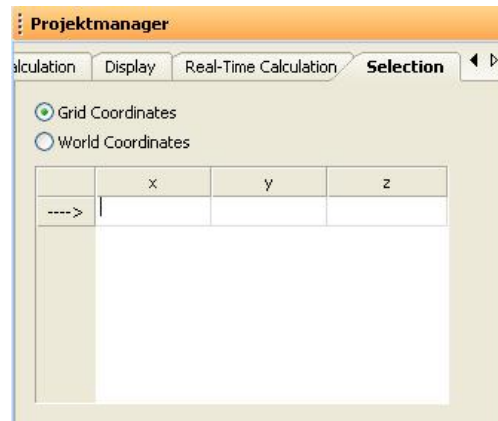

Fig. 325 Changing individual grid points by using coordinates

Under "Selection" in the Inspector the grid points differ according to world and grid coordinates. Grid coordinates depend on the position of the origin of the calculation grid, whereas world coordinates depend on the position of origin of the actual outdoor scene.

Scaling

It is possible in DIALux to scale calculation grids in different ways. To do this, just select the calculation grid and then open the context menu with a right mouse click. Here you can now select the scaling under "scaling options" e.g. with or without anchoring etc.

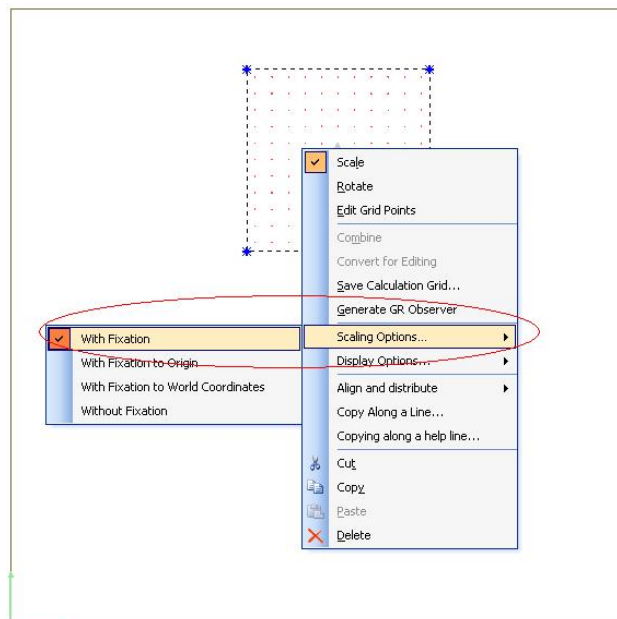

Fig. 326 Selecting scaling options

Merging calculation grids

In DIALux the default setting is that all existing and additionally inserted calculation grids are calculated separately and displayed separately. However you have the option to merge two or more calculation grids and have only one output. For this just select one calculation grid first with the left mouse button, then press the shift key and select one or more calculation grids. Via the context menu (by clicking with the right mouse button on one of the selected calculation grids) you can then finally select the sub-item "Combine".

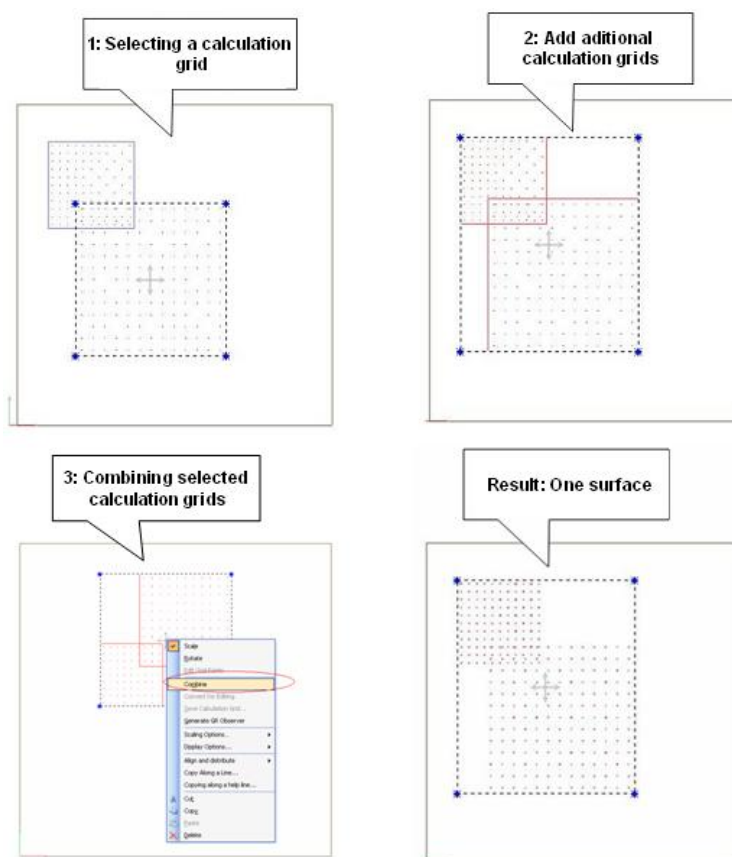

Fig. 327 Step-by-step procedure for merging calculation grids

One possible application for merging or combining calculation grids could be a staircase. So that it is not necessary to have an output of the calculation grid of each individual step, all the calculation grids of the whole staircase can be merged by following the above described procedure.

Calculation points in calculation grids

As mentioned before there is a basic difference between calculation grids and calculation surfaces in the limited number of calculation points. The question therefore

arises as to the options there are to define the quantity and also the distribution of the calculation points in the grid. With DIALux there are three possible ways to make adjustments to the calculation points.

You will find all the methods in the Inspector under the tab "Calculation grid", in the sub-item "Number of Calculation Points".

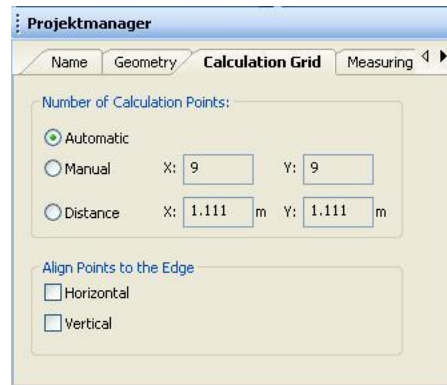

Fig. 328 Methods for defining calculation points

"Automatic": This is the recommended setting if there are no specific requirements. With this method DIALux distributes the grid points uniformly over the whole calculation grid.

"Manual": DIALux distributes the calculation points uniformly with this method too, but in accordance with your specific default settings with regard to the x and y coordinates.

"Distance": With this method you are free to define the distances between the individual grid points yourself. Afterwards DIALux calculates the optimal number of grid points.

In addition to these options you can also decide whether the grid points are positioned at the edges of the horizontal and/or vertical axes. You can decide on the settings in the tab "Calculation grid" under "Align Points to the Edge". Either vertical or horizontal alignment or a combination of both can be chosen.

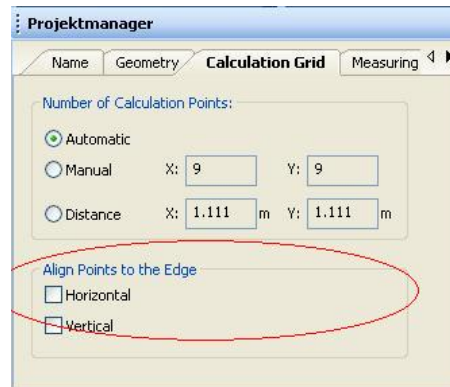

Fig. 329 Aligning the grid points to the edges of the axes

All the above functions refer to quadratic calculation grids. The radial calculation grid has slightly different functions.

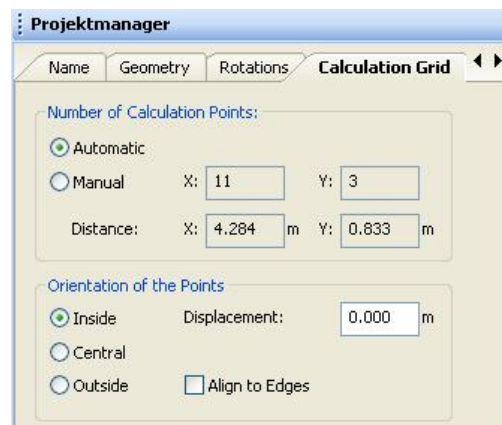

Fig. 330 Inspector "Calculation grid" for radial calculation grids

By contrast, in user-defined calculation grids all grid settings are made individually. Therefore there is no tab "Calculation grid".

Measuring grids

Sports facilities can be dragged into the CAD window. In the project tree one or more calculation grids are listed for a sports facility. Another tab in the Inspector for each calculation grid is available called the measuring grid. A measuring grid is different to a calculation grid and can be inserted as well. There must always be a calculation grid before inserting a measuring grid.

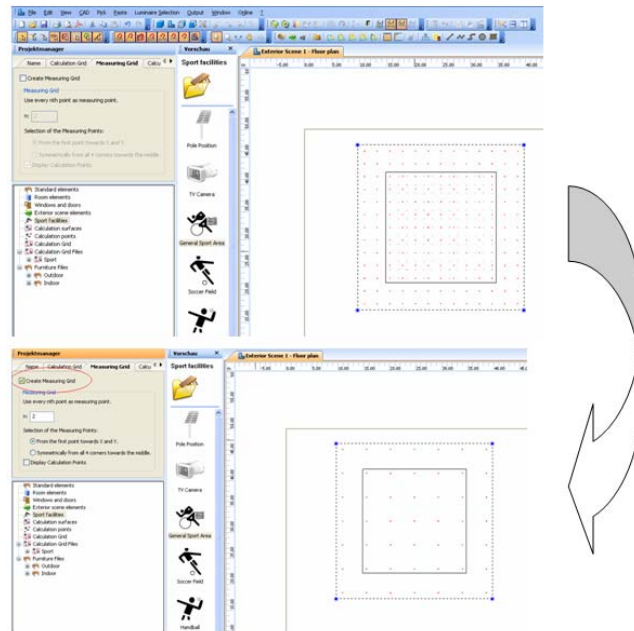

Fig. 331 Creating a measuring grid

In the tab "Measuring grid" different settings can be made. These include defining which grid points and which measuring points should be used. Similarly it is possible to make a setting which visually highlights the measuring points in the calculation grid more clearly by hiding the grid points in the calculation grid.

Calculation

In the tab "Calculation" you can define which values of the calculation grid are to be calculated. You have various options for selecting illuminance and also for changing the values for rotation (in °) and/or the height (in m) individually in the respective selection boxes. You can make changes as follows:

- vertical
- horizontal
- vertical (including angle of rotation)
- semi-cylindrical (including angle of rotation)
- cylindrical
- camera-oriented
- in relation to the outside line
- hemispherical

In this context illuminance is calculated at specific points e.g. at a measuring or calculation point.

To obtain results output carry out a calculation in DIALux with at least one luminaire.

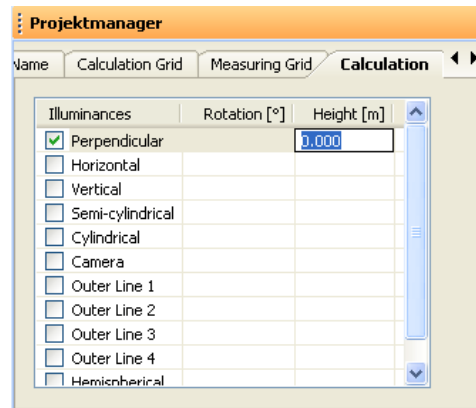

Fig. 332 Pre-setting the calculation of the calculation grid

Gradients

By gradient is meant a rate of change of value between a specific measuring point and measuring points directly surrounding it. The gradient supplies information about the difference in illuminance between this and the measuring points in the immediate vicinity.

Only calculation grids with a uniform and, as a rule, quadratic grid require gradients of illuminance.

In the Inspector, under the tab "Gradients" you can activate gradients and their output, define the corresponding limit value and also define the distance for the gradient grid.

By default in DIALux a gradient lies on a measuring or calculation point - depending on whether you use a measuring grid in addition to a calculation grid.

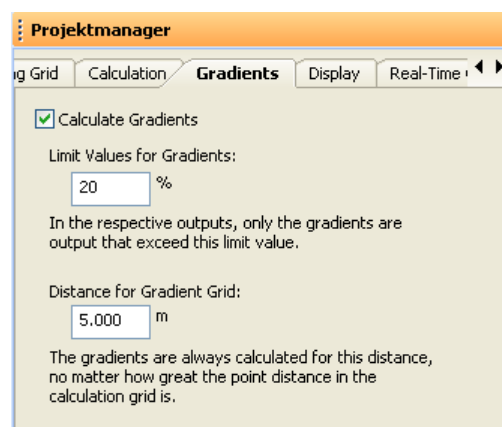

Fig. 333 Setting limit values for gradients

The limit value set prevents loss of image quality in camera or image recordings. This value should not exceed 20% for camera recorded events or 55 % for non-camera-recorded events.

By default, as mentioned above, the gradient grid lies on the calculation- and if applicable also on the measuring grid. Under "Distance for gradient grid" you can change the distance value in the gradient grid individually.

Display settings

In DIALux, calculation grids enable the direct display of results in CAD. This is especially useful in the planning phase of a project. In the tab "Display" of the Inspector for calculation grids the following information can be displayed:

- grid points
- measuring direction
- calculated values
- isolines
- false colours

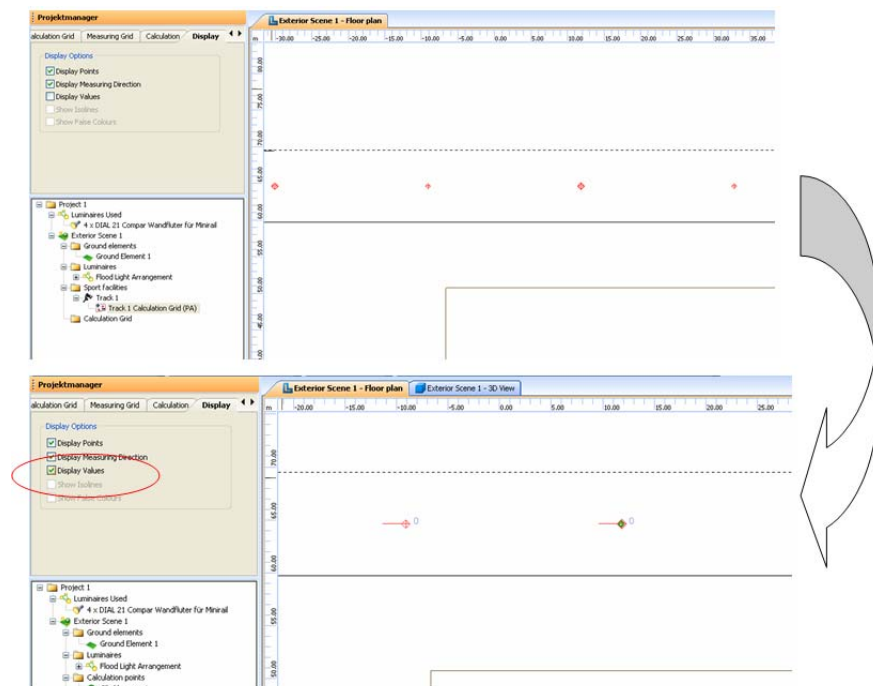

Fig. 334 Changing an output option - Display values

Real time calculation

Often after making changes you want to see the results immediately in CAD but do not wish to run a calculation of the project beforehand. DIALux allows the option in the tab "Real time calculation" of selecting which illuminance you wish to have displayed in CAD. You can select between:

- perpendicular
- horizontal
- vertical

- camera-oriented (at least one camera must be inserted beforehand. These can be found in the project manager under “Sports complexes”.)

The display of the values must be activated beforehand under “Display”. Now you can read the values according to the illuminance option selected directly in CAD.

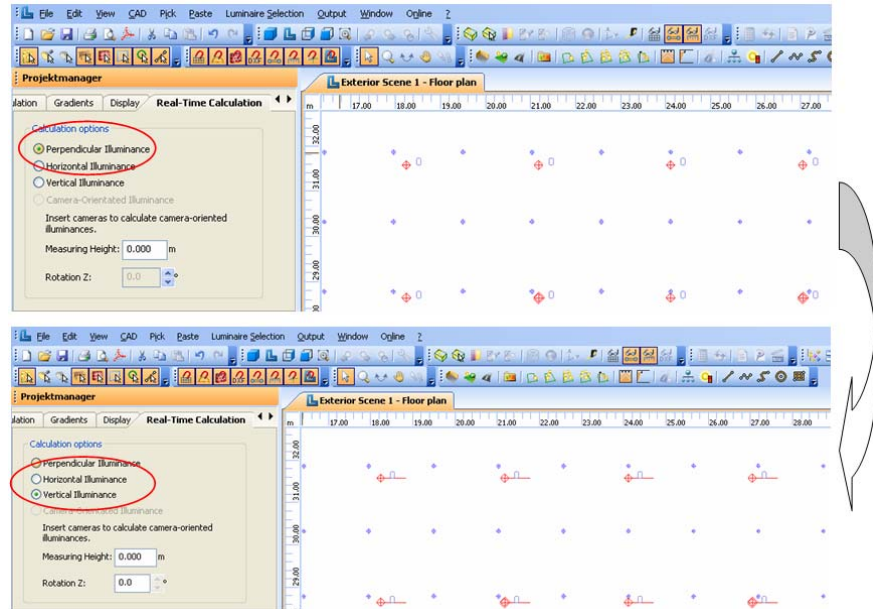

Fig. 335 Procedure and values in real time calculation

After changing the calculation option (e.g. from perpendicular to vertical) not only are the values change in the calculation grid but also the orientation of the calculation points (see previous screenshot).

If several cameras are available, the camera-oriented illuminance option allows you to select each camera in turn to set the measuring height and the rotation of the camera.

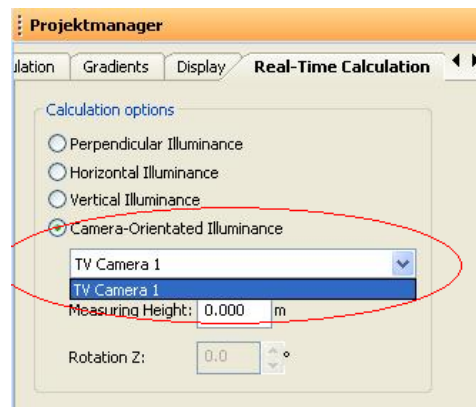

Fig. 336 Camera-oriented luminous intensity – selection and settings

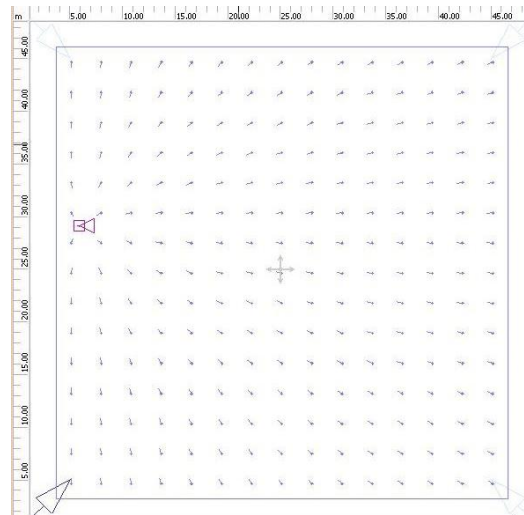

Fig. 337 CAD output of camera-oriented luminous intensity

Isolines

Isolines display equal values of illuminance measured in the vicinity of a luminaire. Isolines can be displayed in CAD in the calculation grid during work on the project. Select the sub-item "Display isolines" in the tab "Display". In the CAD you will now see the isolines of the inserted luminaire(s) in real time.

Real time calculation only functions up to final visualization of the calculation results.

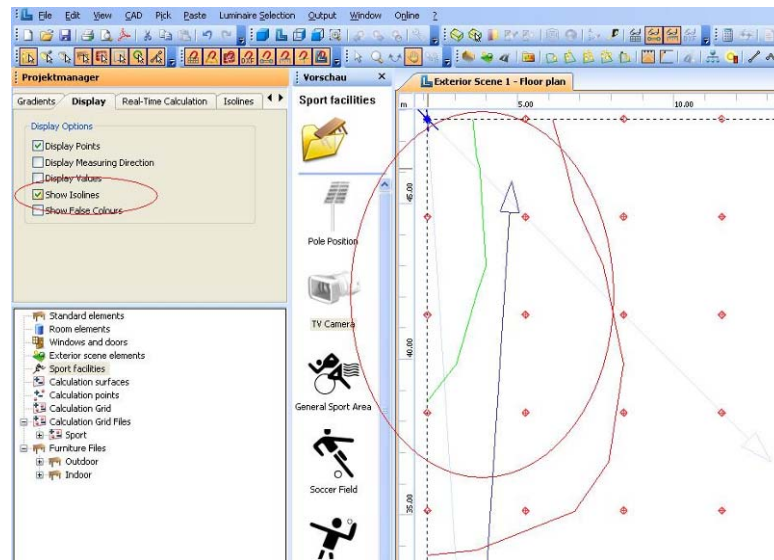

Fig. 338 Displaying isolines in CAD

All settings at this stage also apply automatically for false colours.

The graphic lines illustrate the level of illuminance according to individual settings. These settings can be changed and adjusted in the tab "Isolines". Isolines

created in this way can be saved as user default settings in DIALux. In addition, it is also possible in DIALux to open standard specifications. To do this, select the required isoline profile in the sub-item "Standard specifications". For example, profiles for sports complexes or emergency lighting are available.

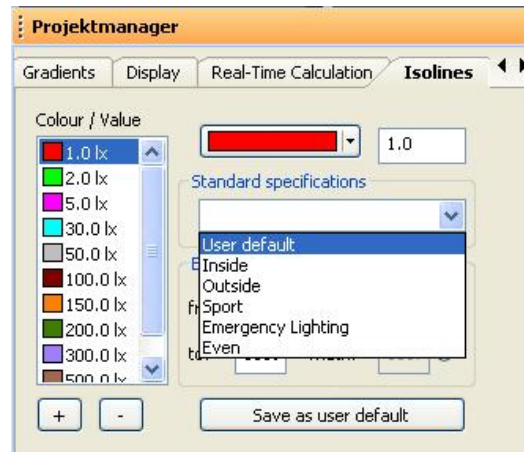

Fig. 339 Selecting an isoline profile

Calculation Points

To get calculation results for a number of selected points. You can use horizontal calculation points, vertical calculation points and free calculation points.

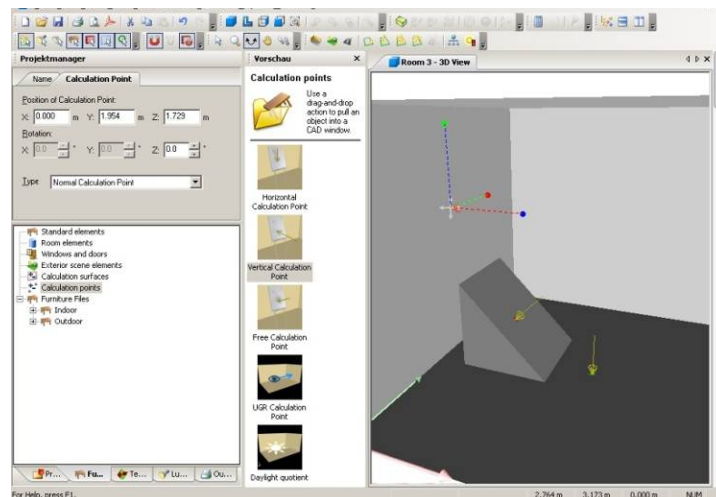

Fig. 340 Calculation points

Horizontal calculation points (shown at the right side of the figure above) cannot be rotated. They always "measure" the planar illuminance of the perpendicular incoming light.

Vertical calculation points (shown at the left side of the figure above) can be turned about the Z-axis. They can "measure" the planar ("normal") illuminance, the semi-

cylindrical illuminance or the cylindrical of the incoming light. This type can be selected in the Property Page.

Free calculation points can be rotated about all axes. They "measure" the planar illuminance of the light incoming in the direction of the arrow.

The output lists of all calculation points are on one page ("Calculation Points List"). They are sorted according to their type (planar, semi-cylindrical, cylindrical) and their designation. The summary of the results shows maximum, minimum and average value.

Calculation points are a good tool to get the illuminance of stairs, blackboards, etc.

UGR Calculation

A major enhancement of DIALux affects the UGR calculation. It can produce the following UGR results:

- 1) The UGR table for all luminaires with direct lighting with a spacing to height ratio (SHR) of 0.25 or 1.
- 2) The single sheet output and the summary of "standard rooms" (rectangular, without furniture, only one type of luminaire) shows the four standard UGR values for the left wall and the lower wall viewing lengthways and across the luminaire axis. This saves doing the manual calculation with the help of the standard table.
- 3) You can place UGR observers at workplaces to get UGR values with respect to
 - a. position and viewing direction
 - b. all used luminaires
 - c. position and rotation of the luminaires
 - d. shadowing and reflection
- 4) With UGR calculation areas you get the distribution of the UGR values on an area. The calculation is comparable to the calculation of UGR observers. The output lists information about local glare problems on arbitrary places in the room.

The output of part 1 is a table of the corresponding values. For part 2 and part 3 you get single UGR values. For part 4 you get isolines and greyscale diagram, a chart and a table of the values. Possible UGR values are between 10 and 30. Smaller values are shown as <10. Larger values are shown as >30.

Insert UGR Calculation Point and UGR Calculation Area

You can insert UGR calculation points and UGR calculation areas via drag and drop from the furniture tree into the CAD. NOTE: If you place these objects into

the ground plan, they are inserted at a default height of 1.2 m. This is the standard value that is used for a sitting observer. If you place them into the 3D view, they are placed on the surface you “touch” with your mouse. For example if you place them into the 3D view of an empty room they are positioned on the floor at a height Z=0.

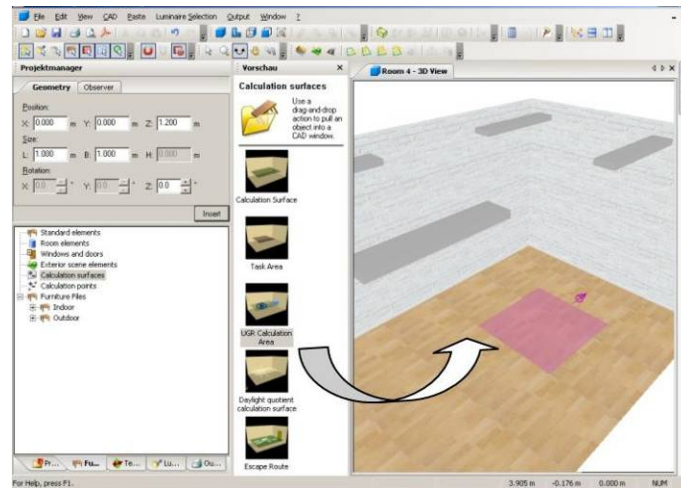

Fig. 341 Insert UGR objects into a room

A second way to insert these objects is to use the Property Page. You just enter the numerical values of the position, the size and the rotation and click on *Insert*. It is the same Property Page that you can use to modify an existing object.

Adjust Viewing Direction of UGR Observer and UGR Area

To adjust the viewing direction, you can use the corresponding Property Page. A direction of 0° means that the observer looks lengthways, the X-axis. A positive angle means a counter clockwise rotation. An arrow shows the viewing direction.

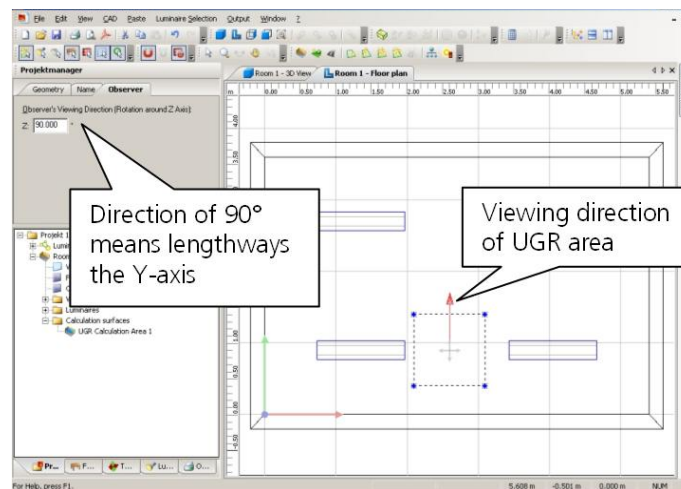

Fig. 342 Viewing direction of an UGR observer

Exterior Lighting

Exterior Scenes

You can use DIALux for planning of exterior scenes with almost the same steps you normally use in indoor lighting. After starting DIALux you will see a startup dialogue.

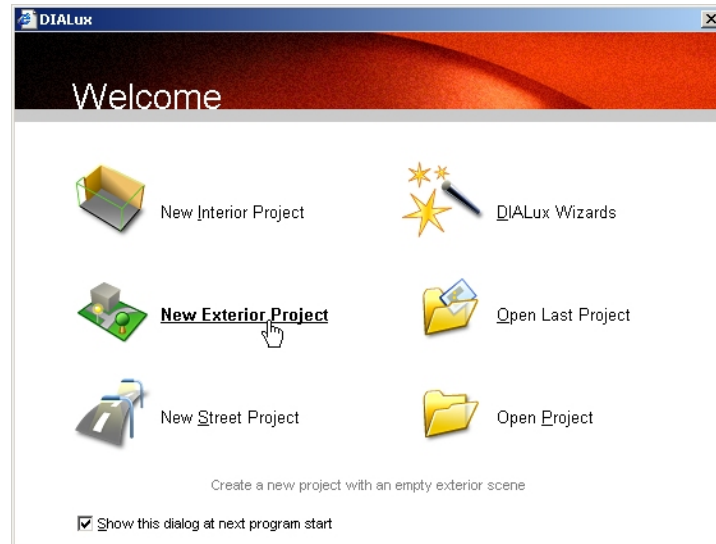

Fig. 343 Startup dialogue

In the startup dialogue you can choose *New exterior project* and DIALux starts with a new empty exterior scene. You can have rooms, exterior scenes and street scenes in one project.

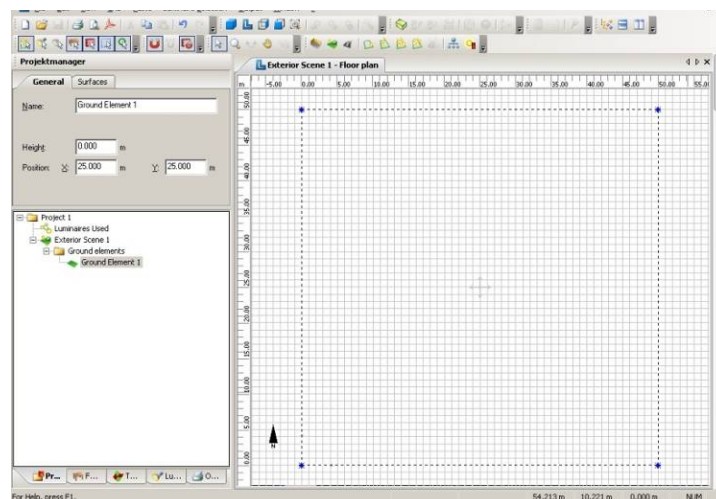

Fig. 344 Start DIALux 4.9 with a new exterior scene

In the *Project manager*, the exterior scene is quite comparable to a room. An exterior scene contains ground elements, furniture and luminaires. The room contains walls, floor and ceiling instead of the ground element.

Ground elements have their own photometric properties. The calculation results are limited to their surface. You can insert additional ground elements from the furniture tree.

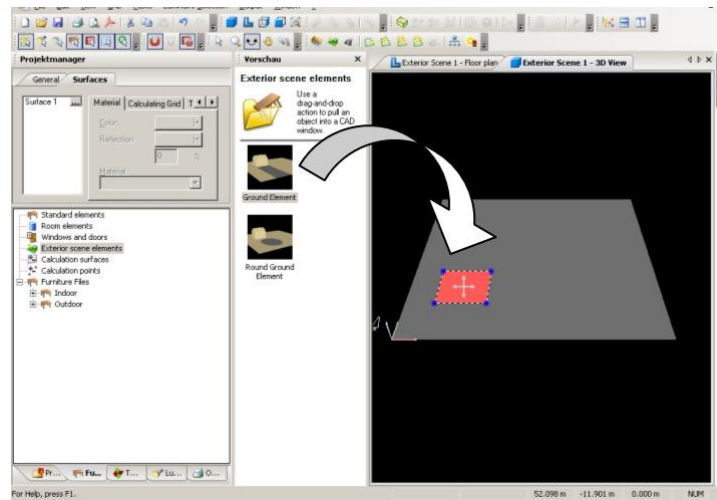

Fig. 345 Insert a ground element from the furniture tree via "Drag & Drop"

You can insert further ground elements from the furniture tree

You can edit a ground element similar to the rooms (see *Edit mode*). They can have any polygonal shape. When you enable the option *Result Output* in the Property Page *Calculation Grid*, DIALux will create the relevant output. You can place furniture and luminaires in the same way as in the rooms of an indoor project.

Ground Elements

A ground element can only be used in an exterior scene. It is an area with a defined shape and an arbitrary height that may for example differ from the rest of the scene only because of its function.

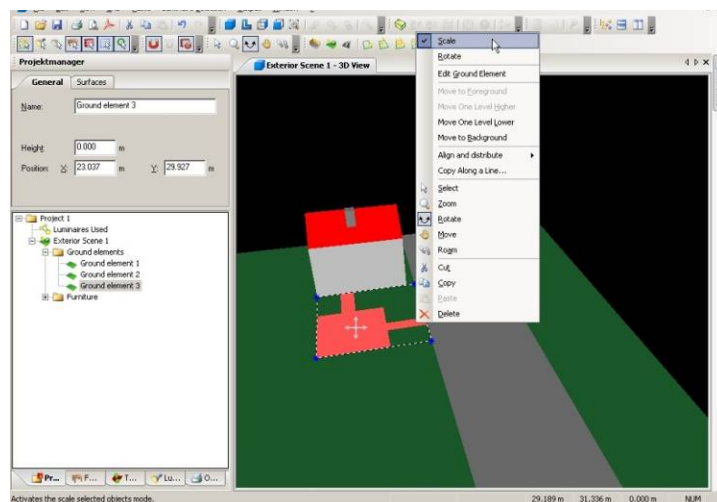

Fig. 346 A ground element

By default a ground element has a rectangular shape and a height of 0.0 m. If you modify the height, the ground element is extruded consists of a top surface and sides. If

you want to modify the shape of the ground element, you can switch to the *Edit* mode with a right click. The *Inspector* shows the different surfaces of the ground element. You can change their material independently and you can select if the different surfaces will be listed in the calculation output. A ground element can appear as a "hole" inside of another ground element. The grey ground element and the selected ground element in the figure above are such "holes" that are cut out of the green meadow. In this example DIALux will not create calculation results for these parts of the outer meadow.

Floodlight Illumination

To calculate the *floodlight illumination* of objects or buildings you start with an exterior scene. On top of the ground element, you place the object you want to illuminate. Now you can select a surface of the object and enable the option *Output Results*.

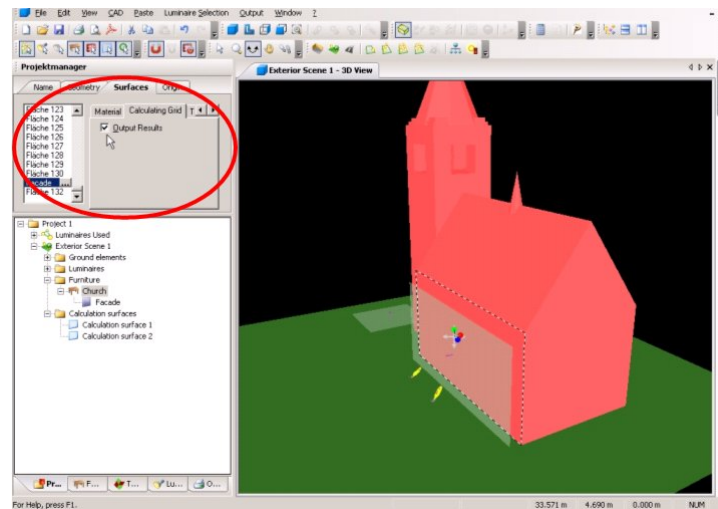

Fig. 347 Calculate results of a surface

... or you can place a calculation surface in front of the object.

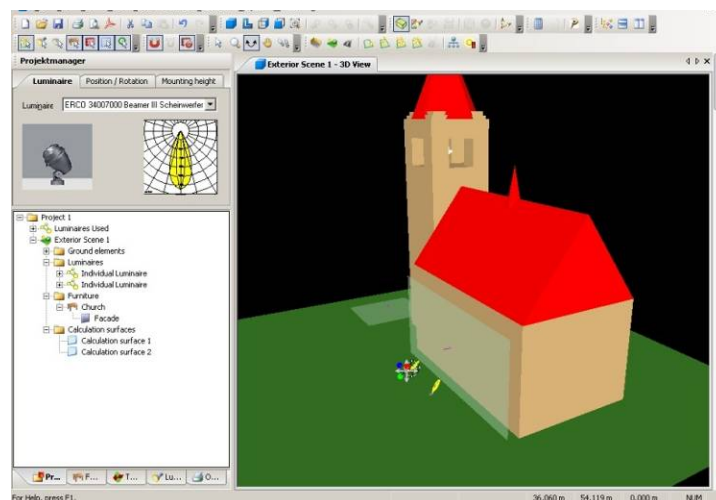

Fig. 348 Illumination of a facade with a calculation surface in front of it

Lighting Design according to prEN12464 Part 2 / EN8995-2

Glare Rating

The draft of EN 12464-2 / EN 8995-2 intends that glare has to be avoided for outdoor working places. To ensure this, glare limits for tasks and activities are prescribed. The glare rating system (GR) is defined in the CIE publication 112:1994. For glare evaluation, the veiling luminances produced by the luminaires and by the environment are the basic criteria. The latter is handled differently by EN 12464-2. In DIALux you can choose, whether you want to use the simplified method of EN or the complete method of CIE. The simplified method approximates the veiling luminance produced by the environment (L_{ve}) with the formula $L_{ve} = 0.035 \times \rho \times E_{hav} \times \pi$, where ρ is the average reflection and E_{hav} the average illuminance of the "area". Unfortunately this "area" is not exactly defined. DIALux uses all ground elements as the "area".

The complete method of CIE 112:1994 uses the correct veiling luminance produced by the environment in front of an observer. Here the illuminated area is considered to consist of an infinite number of small light sources. The veiling luminance produced by the environment is

$$L_{ve} = 10 \sum_{i=1}^n \frac{E_{eye i}}{\Theta_i^2}$$

defined by the formula where n is the total number of small light sources. Of course, this calculation is more accurate but more time consuming too. The DIALux outputs state which method was used to calculate GR values.

The screenshot shows the 'GR Observer' configuration window. The 'Name' field is set to 'GR Observer'. Under 'Position of GR observer', the coordinates are X: 8.180 m, Y: 27.685 m, and Z: 1.500 m. The 'Angle of inclination' is set to -2.0, and the 'Step width' is 15.0. The 'Viewing angles from' is 0.0 and 'to' is 360.0. Two radio buttons are present: 'Simplified calculation according to EN8599' is selected, and 'exact calculation according to CIE 112' is unselected.

Fig. 349 Property page of the GR Observer

To calculate GR values, DIALux provides the GR observer tab. Any GR observer can be placed just like any other

calculation point. There are some special properties, an inclination angle, viewing angles from a start to an end angle and a step width. The inclination angle defines the observer's viewing direction towards the horizontal. Start and end angle define the observer's vertical viewing section. Here 0° is the direction along the positive X-axis, positive angles move counter clockwise. Step width defines the different viewing directions between start and end angle.

GR observers can easily be placed as a line or even as a field by using the function "Copy along a line".

Obtrusive Light / ULR Calculation

The ULR (Upward Light Ratio) value is the percentage of luminaire flux of a luminaire or a lighting installation that is emitted above the horizontal, where all luminaires are considered in their real position in the installation. Sky glow limitations depend on the environmental zone of the lighting installation. The standard defines four environmental zone categories from E_1 to E_4 . E_1 category is used for intrinsically dark landscapes like national parks or areas of outstanding natural beauty. E_4 category is used for high district brightness areas like city centres. Sky glow limitations reach from 0% to 25%.

DIALux states the ULR value on the "Planning data" output page for exterior scenes. DIALux considers only luminaire flux that goes directly into the sky. Luminaire flux above the horizontal, that is both used for lighting of vertical structures such as facades, and is restricted to these structures, will not be considered.

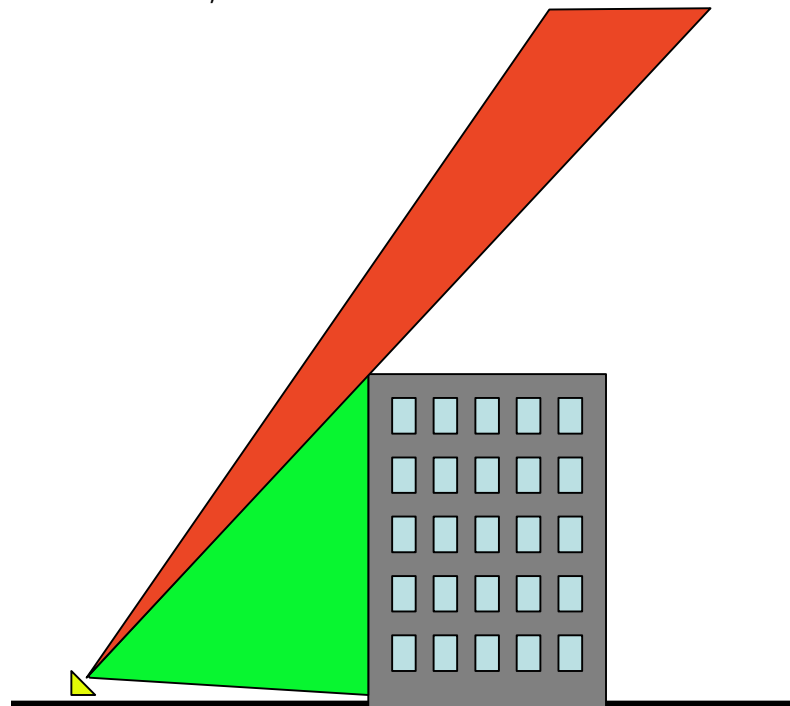
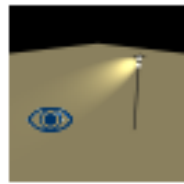

Fig. 350 Luminous flux that is taken into account for the ULR value

Obtrusive Light / Luminous Intensity Calculation Point

To minimize obtrusive light, EN 12464 not only gives limitations for ULR values but also for luminous intensity values in obtrusive directions and light trespass into windows. These limitations depend on the environmental zone category as well. Limitations for light trespass into windows are given in lux. Values can easily be calculated with calculation points and calculation surfaces. To calculate luminous intensity values in obtrusive directions DIALux offers Luminous Intensity Calculation Points. Such points can be placed just like any other calculation points. They consider all luminous intensities of all light emitting surfaces of all placed luminaires. So for a luminaire with two brackets two values are calculated. DIALux uses the luminaire's LDC in the installed position, the luminaire flux, the dimming level and the corrections factor, if applicable, for calculation. A Luminous Intensity Calculation Point can be placed for each potential obtrusive direction.



Luminous intensity
calculation point

Fig. 351 Luminous intensity calculation point

List entries

List all luminaires and their light emissions.

List only those luminaires and their light emissions with interference effects that exceed the following limit value.

Limit value: cd

Fig. 352 Property page for the outputs of the luminous intensity calculation point

The luminous intensity calculation point output can be reduced to such luminaires and light emitting surfaces that do not hold a given limitation.

Street Valuation Fields in Exterior Scenes

DIALux users often expressed their wish to use “real” situations for street lighting planning. That is not possible in a design according to EN 13201 or the obsolete DIN 5044. The “standard street” does not encompass curves or the possibility of changing single luminaire technical values or positions. So we added a new calculation surface for exterior scenes to DIALux, which calculates the luminance distribution on a roadway for an observer: the Street Valuation Field. This calculation considers exactly all luminaires and other objects placed in the exterior scene. Indirect light, e.g. reflections from facades, is not considered, shadowing through trees or buildings is. Because of the strict definitions of street lighting standards, the results of a Street Valuation Field should be used with extreme caution regarding the limitations of EN 13201. Whereas the “standard street” considers a certain amount of luminaires in a line in front and behind a single calculation point, the new calculation surface considers all luminaires in the exterior scene, even luminaires with other tasks.



Street-valuation
field

Fig. 353 Calculation surface Street-valuation field

A Street Valuation Field consists of two parts: the calculation surface itself and a corresponding observer. The surface is visible in CAD windows and can be changed as needed. It can even be polygonal. The observer position and his viewing direction define the calculation grid of the surface. This grid is displayed by little crosses in the CAD. Grid point counts are able to be changed; initially there are 10 x 3 grid points. Initially the observer is placed 60 m to the left from the start of the surface. This is the observer position in a “standard street”. The position can be changed as needed. His viewing direction is 0° that is in direction of the positive X-axis. Therefore the grid points are initially parallel to the X-axis as well.

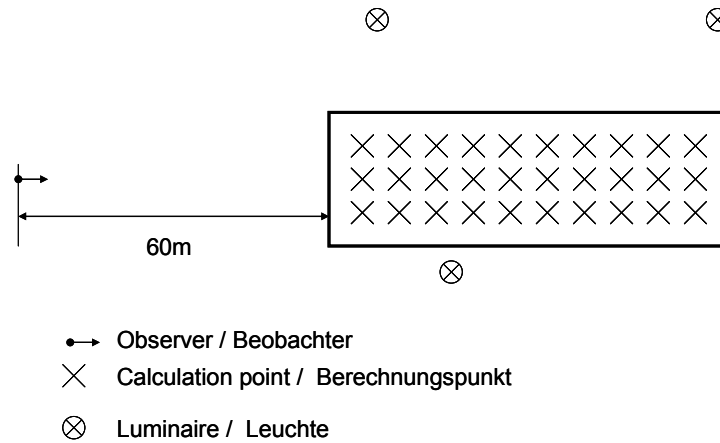

Fig. 354 Simple Street-valuation field in an exterior scene

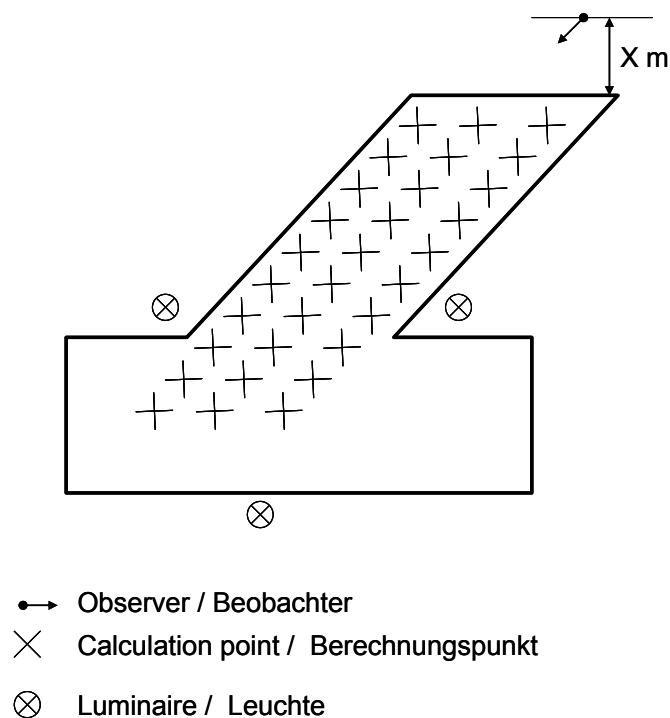

Fig. 355 Complex Street-valuation field in an exterior scene

The first graphic shows a simple example for Street Valuation Fields. It is very close to a "standard street" from EN 13201, only luminaire positions are different. The second graphic shows a more complex example. The observer is placed in the side street and views towards the crossing. His viewing direction (ca. 225°) defines the calculation grid's orientation.

Note: Reflection properties of tarmacs are only defined for close sectors. If the observer is placed too close to or too far away from the surface, no luminances can be calculated.

Road lighting

Standard Streets

You can use DIALux 4.9 for planning *standard streets*. You may also use a calculation of streets together with rooms or exterior scenes in one project. To insert a street in your project you can select it from the DIALux welcome screen,

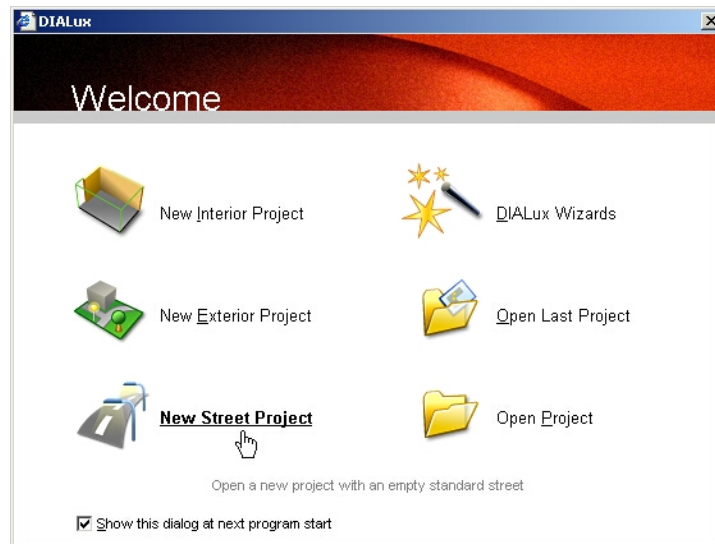

Fig. 356 Startup dialogue DIALux – New street project

from the menu *Insert* → *New Scene* → *Standard Street*

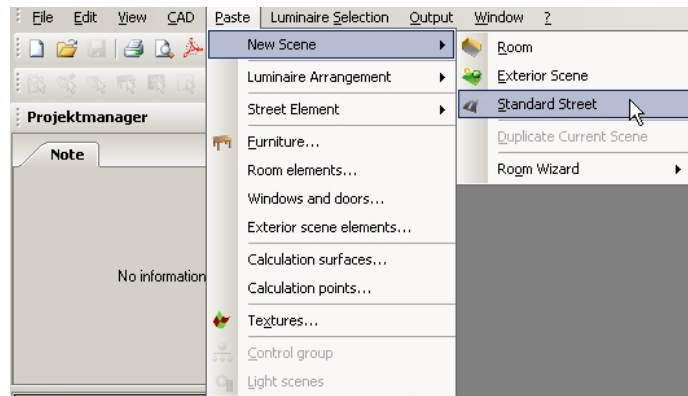

Fig. 357 Insert Standard Street via menu

or from "The Guide".



Fig. 358 Insert Standard Street via "The Guide"

You can calculate your projects also by means of our quick street planning wizard (see also chapter *Working with Wizards*).

Planning with standards

In 2005 EN 13201 was established for street lighting planning. DIALux users can do street lighting planning according to that standard since the version 3.1.5. But sometimes it is still necessary to plan with obsolete DIN 5044, for example for checking old street luminaire arrangements. For such circumstances, DIALux allows street light planning according to DIN 5044 since the Version 4.2. There is another option with DIALux Version 4.9 to plan road lighting. As of now you can plan road lighting with the *American standard IESNA RP-08-00* in addition to the *CIE 140 / EN 13201* and the *DIN 5044*. To do this planning you have to set the corresponding *Radio-Button* at the *inspector* in the *Property Page "General"*. If you want to plan with the DIN 5044 you have to select the option in the *drop-down list*.

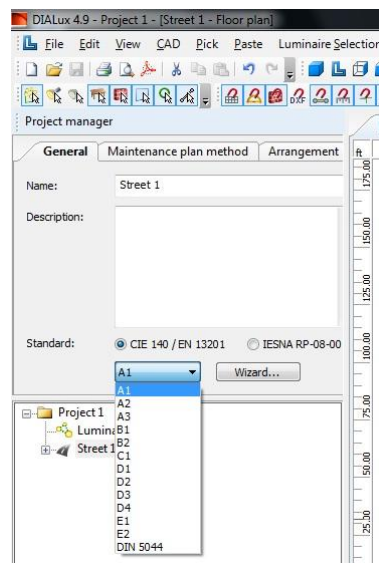

Fig. 359 Planning with standards for road lighting

Of course you also can select the standards in the wizards (see *Quick Street Planning Wizard* and *Optimised Street Light Arrangement Wizard*).

There is a difference between North American (IESNA) standard and European (EN) standard at the arrangement of the luminaire during the photometric measurement. To conform the IESNA to the EN DIALux it is possible to rotate the *LDC* 90°. Basic: you can rotate the *LDC* without turning the geometric of the luminaire out of position.

The American standard works in road lighting with *IES-files*. In the *IES-file* the "*horizontal0*" (it's the equivalent to the *CO-plane*) is aligned *perpendicular* to the kerb.

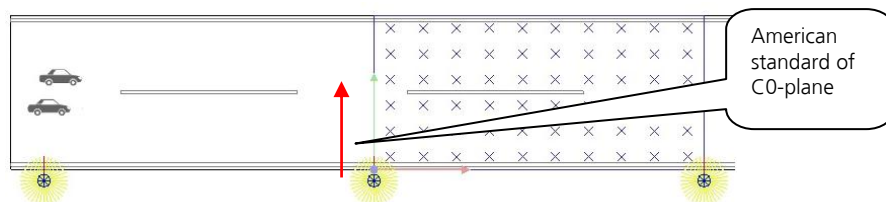

Fig. 360 American standard of CO-plane

Instead of that the European standard works with an alignment of the *CO-plane* parallel to the kerb.

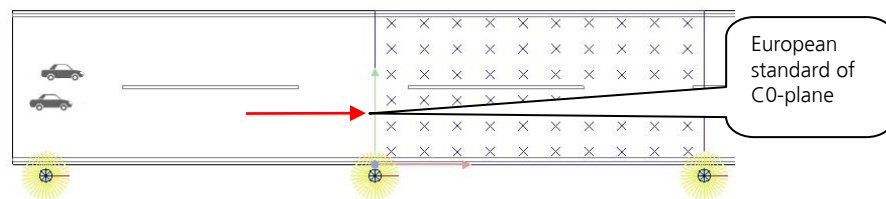

Fig. 361 European standard of CO-plane

In DIALux a window is displayed at the import from *IES-files*. To rotate the *LDC* you have to set the corresponding *checkbox*. In case of need it is possible to modify the geometry of the luminaire. That is necessary because the *IES-file* defines only the *light emitting surface*.

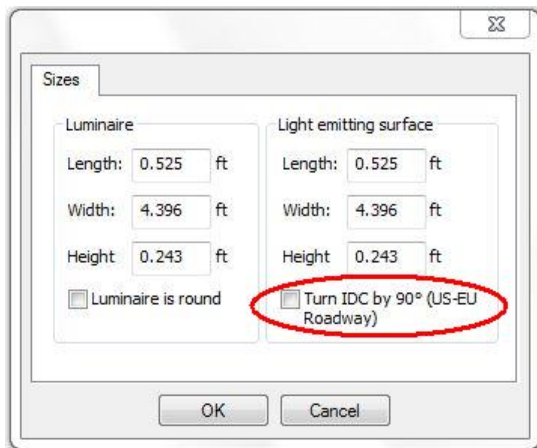

Fig. 362 IES-file import

You can rotate the *LDC* later too. For that purpose you have to select the luminaire in the *project manager*

under used luminaires and then you have to set the check box in the *property page "technical data"*.

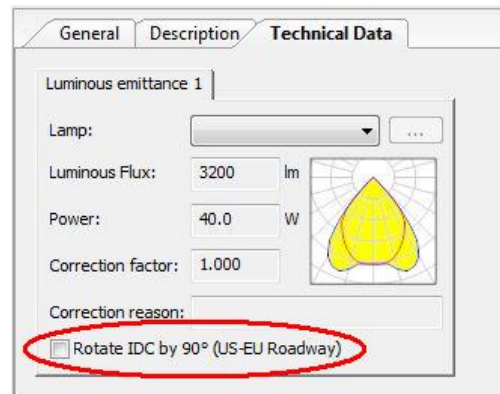

Fig. 363 LDC rotation

Street Planning without Wizard

By default a street only consists of one roadway with a valuation field (at the beginning of a street planning).

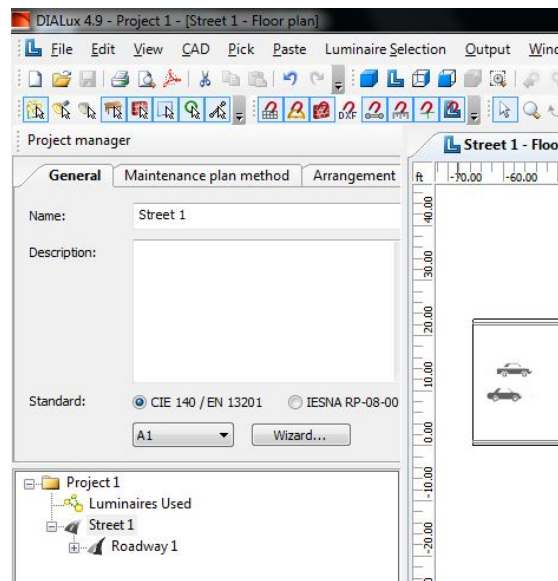

Fig. 364 Insert a new standard street

When you mark the street in the *Project manager*, you can adjust some *general settings*. In the *property page "general"* you find options for the *name*, for a *detailed description* and for fix the *illuminance conditions*. The initial setting in DIALux is the *standard CIE 140 / EN 13201*.

In the European standard CIE 140 / EN 13201 you can select the *illuminance condition* manually at the *drop-down list*. By default your street (project) always gets an illuminance condition with the *designation A1*. The luminance condition is based on the Technical Report of

the European committee for standardisation CEN/TR 13201-1. It serves as a basis for the definition of requirements for the street illumination.

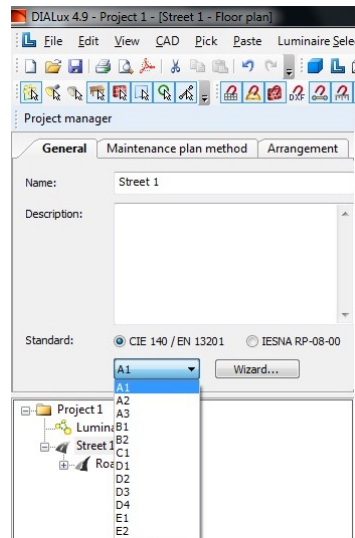

Fig. 365 luminance conditions

By means of a wizard the respective illuminance condition of the street can be determined systematically. The *illumination condition wizard* can be started using the "Wizard... button" (see also chapter *Illumination Conditions Wizard according to CIE 140 / EN13201*).

At the Property Page Maintenance plan method you will find options to modify the light loss factor and reference values.

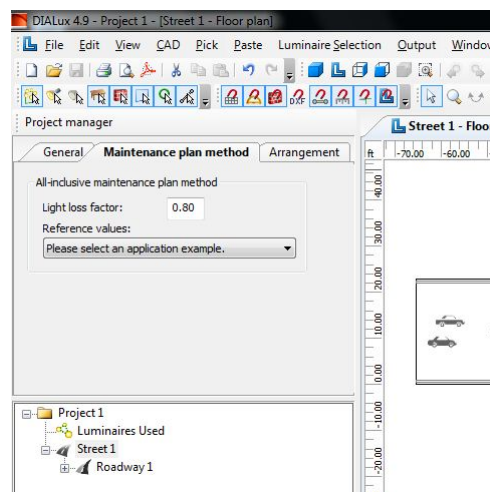

Fig. 366 maintenance plan method

A standard street may contain certain street elements, which you can add, sort or delete in the Property Page *Arrangement*. To sort the street elements (e.g. sidewalk, bicycle lane, lay-by,...) you can select one of these and use the *Up* or *Down* buttons.

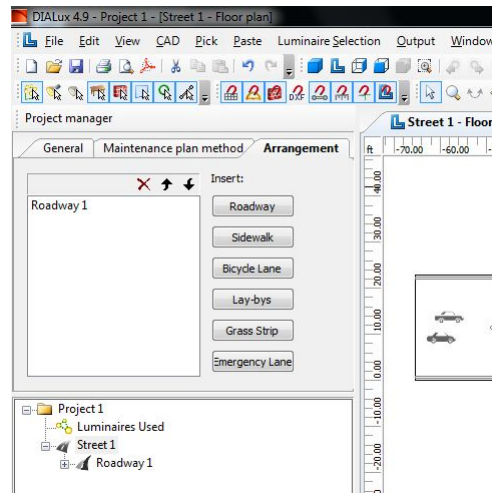

Fig. 367 Insert and arrange the street elements

Optionally you can insert street elements in the menu
Paste → *Street Element*

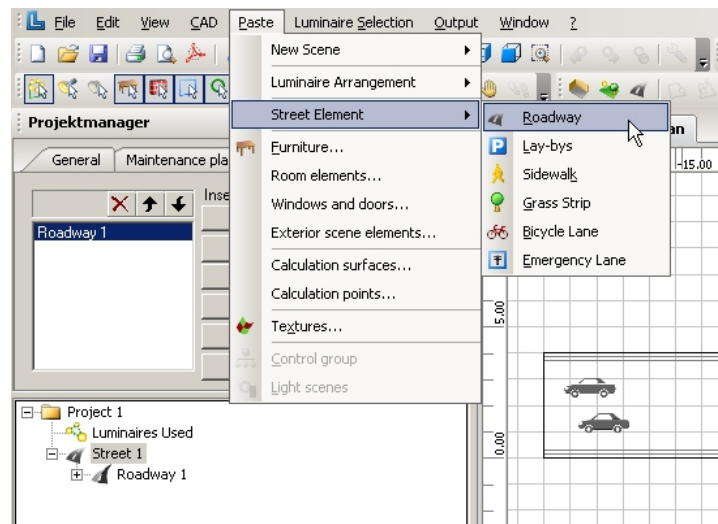

Fig. 368 Insert street elements via menu

or by means of the right mouse in the context menu of
the street.

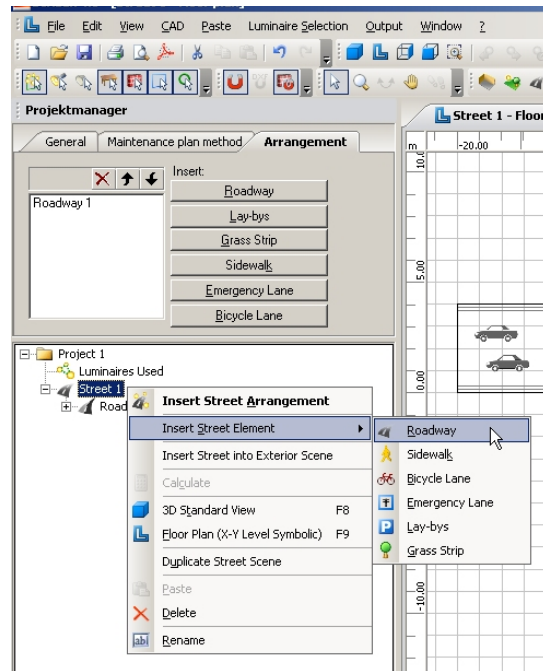

Fig. 369 Insert street elements via context menu

You can select a single street element at *CAD* or *project manager*. The *inspector* shows the characteristics of the individual *street-elements* like which you can modify user-defined. To modify, in the inspector you have to select the lane in the project manager.

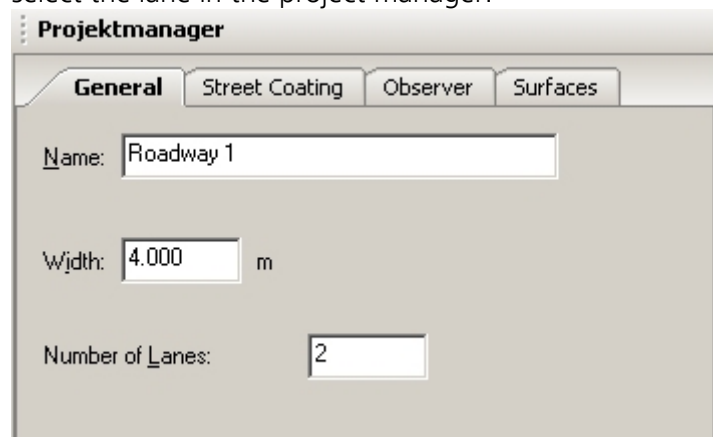

Fig. 370 Properties of a roadway – General

The tarmac and the luminance coefficient can be modified in the Property Page *Street Coating*.

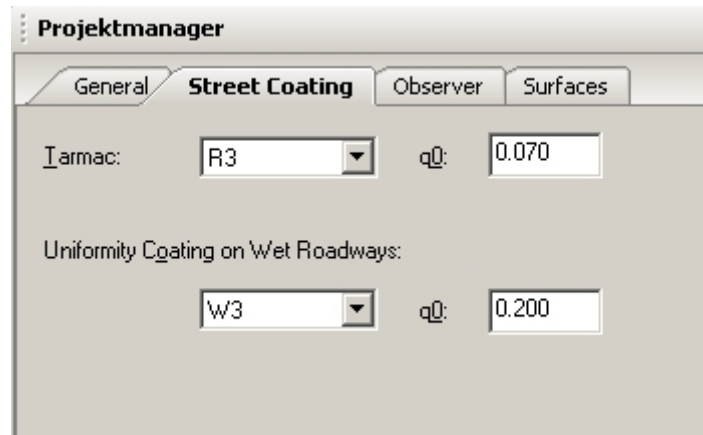

Fig. 371 Properties of a roadway – Street coating

At the European standard each street has an observer whose average age can be varied individually for the calculation of TI.

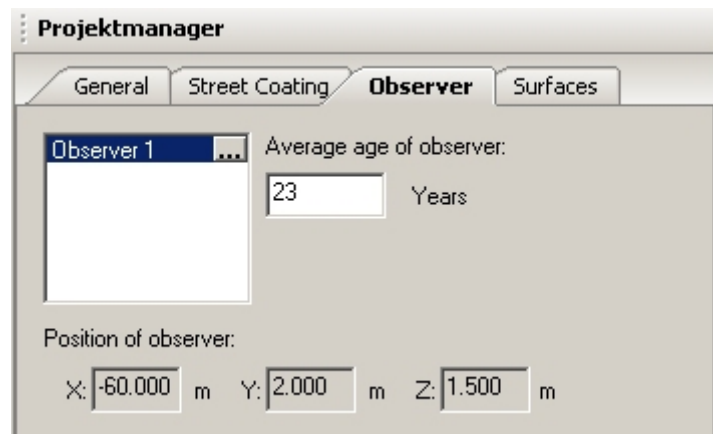

Fig. 372 Properties of a roadway – Observer

DIALux positions the observers automatically according to the default of the EN. The observer is always 60m in front of the valuation field in the middle of the respective roadway, at a height of 1.5m above the ground. Normally every roadway has an observer who looks in the direction of the driving direction. On the basis of the resulting symmetries a rotation of the observation direction is not necessary.

Note: The *Property Page "Observer"* is only available in the standard CIE 140 / EN 13201. Would you like to adjust the age of the *observer* in the IESNA RP-08-00 you can modify this in the *Inspector "Calculation Grid"*.

The *Property Page Surfaces* offers the possibility to set *material, texture and Raytracer Options*. All settings only have an effect on the visualisation, but not on the calculation results.

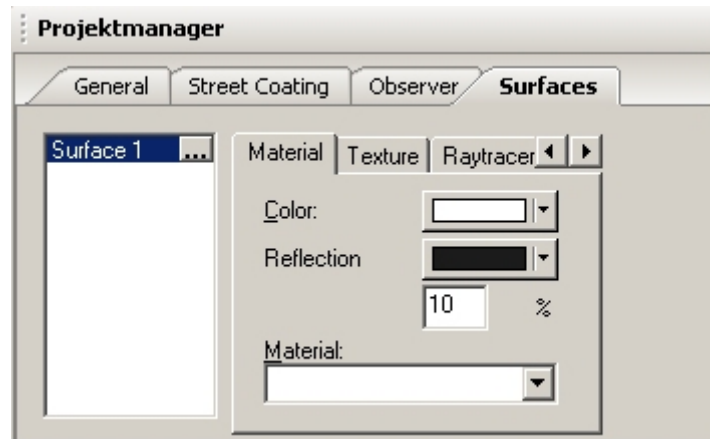

Fig. 373 Properties of a roadway – Surfaces

In the default setting median, parking lane and grass strip have no valuation field. Nevertheless, this can be inserted, while the respective street element is marked in the *Project manager* and with the right mouse button the option *Insert Valuation Field* is chosen.

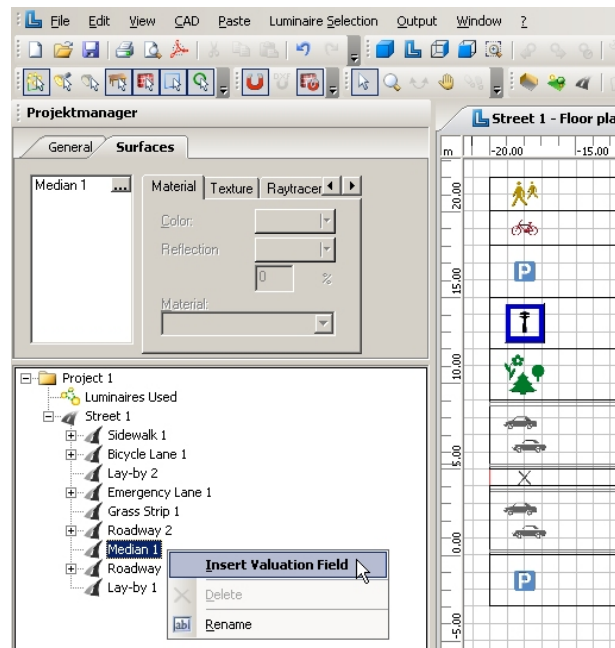

Fig. 374 Insert valuation field via context menu

Similarly a valuation field can be deleted or renamed by means of right mouse button.

DIALux allows the use of common valuation fields for different roadway elements. In the wizard this is possible by choosing the suitable checkbox. If additional validation fields are selected several more steps are necessary. DIALux defines for every surface (except median, parking lane and grass strip) a valuation field. Now if you want to have, for example, a bicycle lane and a sidewalk with a common valuation field, you must first cancel the existing valuation fields. Then select both roadway elements for which you would like to have a

common valuation field by pressing the shift key and clicking those roadway elements. Then do a right-click on the marked objects and choose *Insert Valuation Field*. Now you will get a common valuation field for both roadway elements.

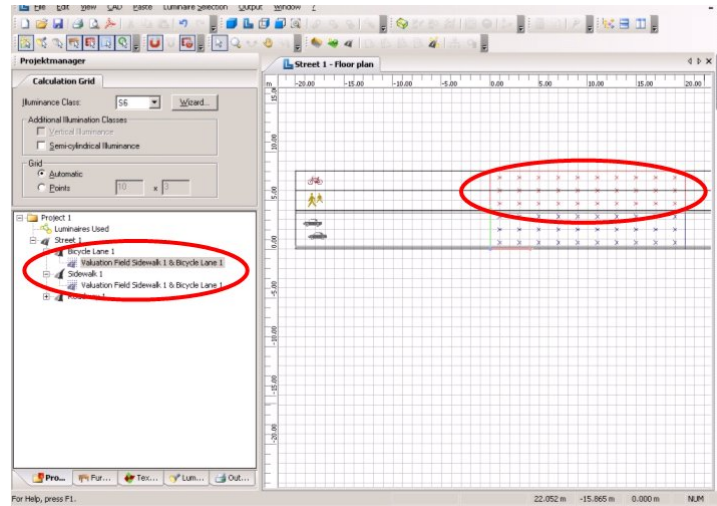

Fig. 375 Common valuation field

If you mark a *valuation field* in the *Project manager*, the *Property Page calculation grid* opens in the *Inspector*.

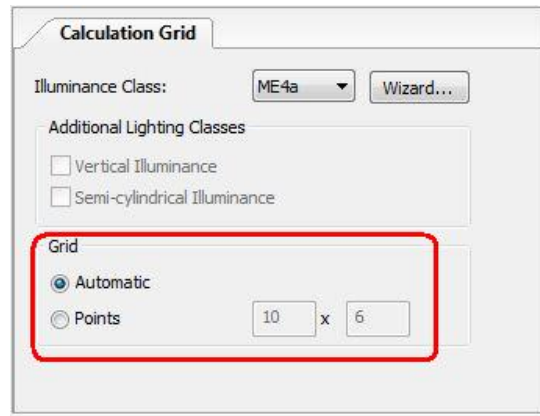

Fig. 376 Calculation Grid

The grid is generated automatically according to the selected standard. If the checkbox "Automatic" is chosen, the right number of calculation points is always chosen. If you want a different grid you can give the number of the calculation points in the X direction (longitudinal direction of a roadway) and the Y direction (width of a lane), after you have activated the checkbox "Points".

Caution: Then the results are no longer according to the corresponding standard.

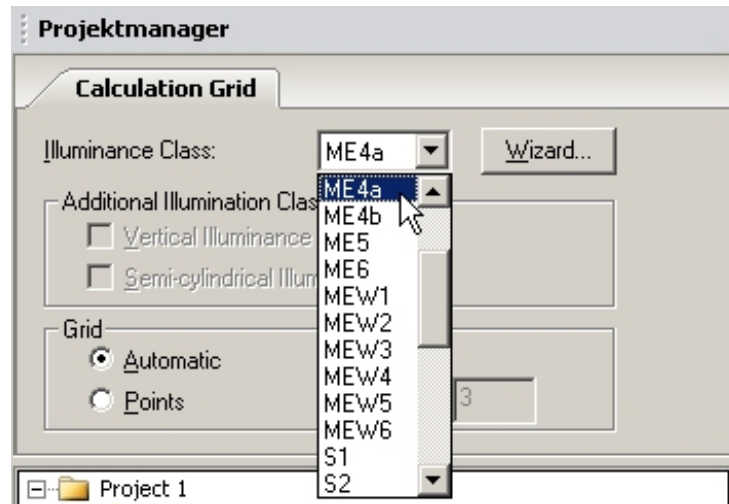

Fig. 377 Calculation Grid – Illuminance Class

In the Calculation Grid you have additionally the option to specify the illuminance class. Here you have essential differences in the adjustments from the European standard to the American standard. In the European standard either the given illuminance class is selected manually from the available list, or by using the wizard to determine the illuminance class in according to the European Standard CEN/TR 13201-1.

NOTE: If you need support by selecting the *illuminance class*, you can use the *illuminance class wizard* (see also chapter *Illuminance Class Wizard according to CIE 140 / EN13201*).

The *illuminance class* contains a summary of the photometric requirements for your project which depends on the visual needs of specific street users using different kinds of traffic surfaces and their environment. Additionally *illuminance classes* can be chosen according to street situation for *vertical* and *semicylindrical* illuminances (see EN13201 – 1, chapter 6.4).

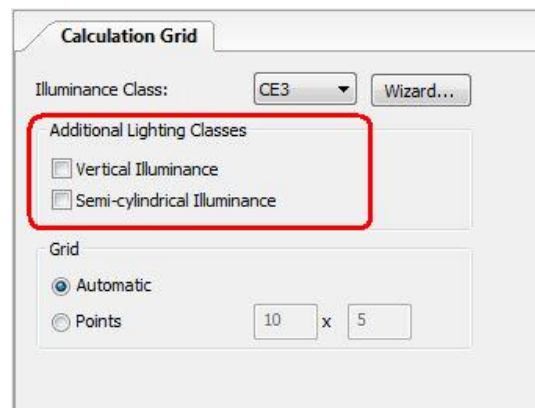

Fig. 378 Additional lightning classes

For valuation fields requiring illuminances rather than luminances it can be necessary within the scope of the norm to calculate each of four illuminance dimensions dependent on the interpretation criteria according to EN13201-2. These are:

- horizontal illuminance;
- hemispherical illuminance;
- semicylindrical illuminance;
- vertical illuminance.

Horizontal illuminance is always calculated. However, in some countries hemispherical illuminance is needed instead of horizontal illuminance.

Similarly this is always calculated and can be selected in the output for the printout. In table 4 of the CEN/TR 13201-1 the alternative A-classes are specified for the S-classes. Accordingly DIALux changes the necessary illuminance dimensions in the outputs.

Horizontal illuminance:

Calculation points shall be located in a plane at ground level in the relevant area.

Hemispherical illuminance:

Calculation points shall be located in a plane at ground level in the relevant area.

Semicylindrical illuminance:

Calculation points shall be located in a plane 1.5m above the surface in the relevant area. Semicylindrical illuminance varies with the direction of interest. The vertical plane at right angles to the rear flat surface, shall be oriented parallel to the main directions of pedestrian movement, which for a road is usually longitudinal.

Vertical illuminance:

Calculation points shall be located in a plane 1.5m above the surface in the relevant area. Vertical illuminance varies with the direction of interest. The vertical illumination plane shall be oriented at right-angles to the main directions of pedestrian movement, which for a road are usually up and down the road.

You can activate the wizard for the determination of an illumination class via the wizard... button (see figure above). After starting it you are welcomed by a welcome screen.

If the user needs a road lighting planning with the American standard RP-08-00, there are several selection criteria for the *illuminance classes* available. Additionally to the separate *illuminance class*, you have to select a method.

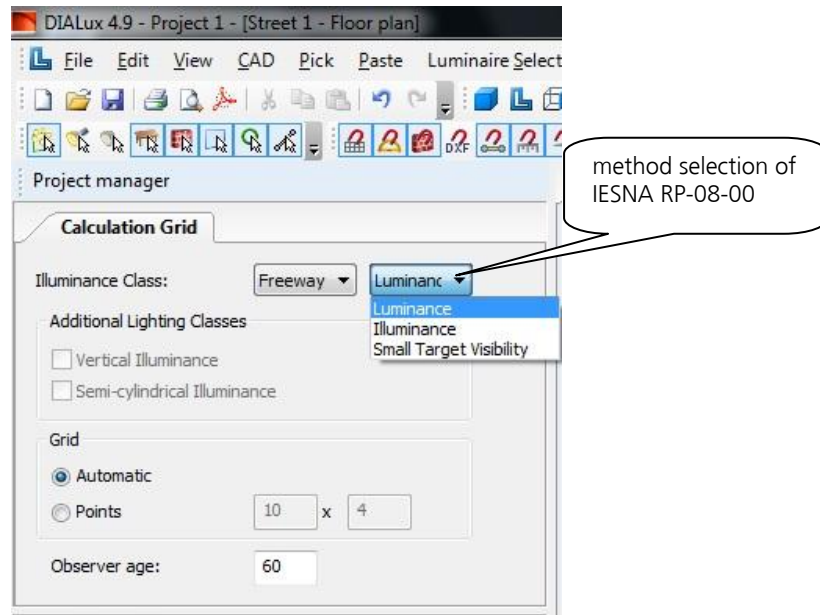

Fig. 379 Method selection

NOTE: There are no methods available for pure Sidewalks and bikeways classes.

A standard street can contain several *street arrangements* of luminaires but no other luminaire arrangements or furniture. The *valuation field* is defined with the first inserted street arrangement.

To insert the street arrangement you can use "The Guide"

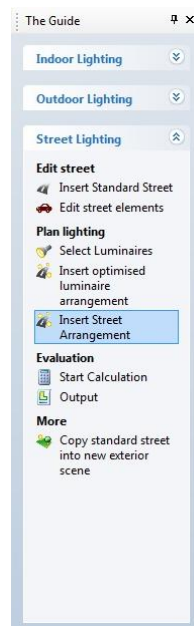

Fig. 380 Insert street arrangement via "The Guide"

or the menu *Insert* → *Luminaire Arrangement* → *Street Arrangement* when you have selected the street in the *Project manager*

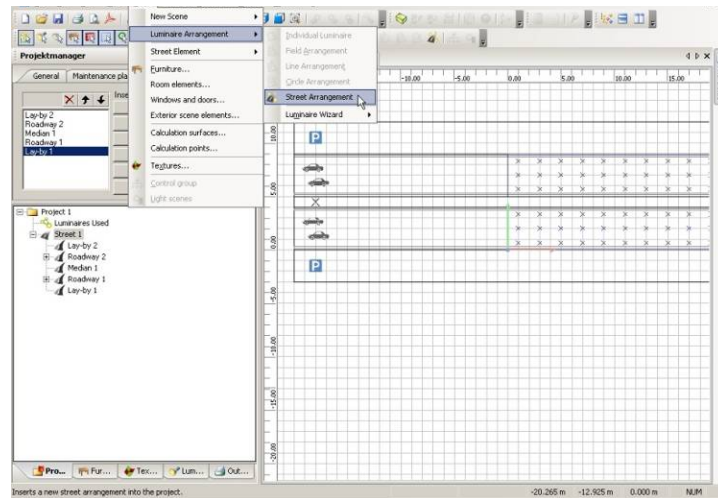

Fig. 381 Insert street arrangement via menu

or by means of right mouse button, after you have picked the street in the *Project manager*.

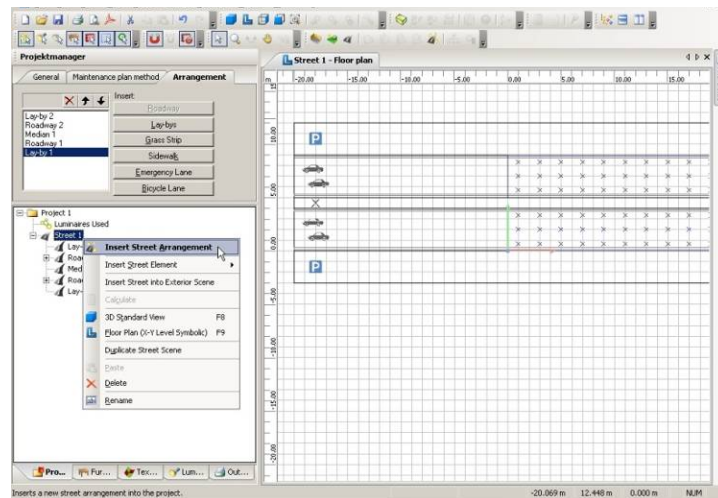

Fig. 382 Insert street arrangement via right mouse button

DIALux 4.9 offers all the key parameters for positioning street luminaires.

First you choose the type of luminaire in the *PlugIn* of a manufacturer. After using the option “*insert street arrangement*” you can choose a luminaire from the *list*.

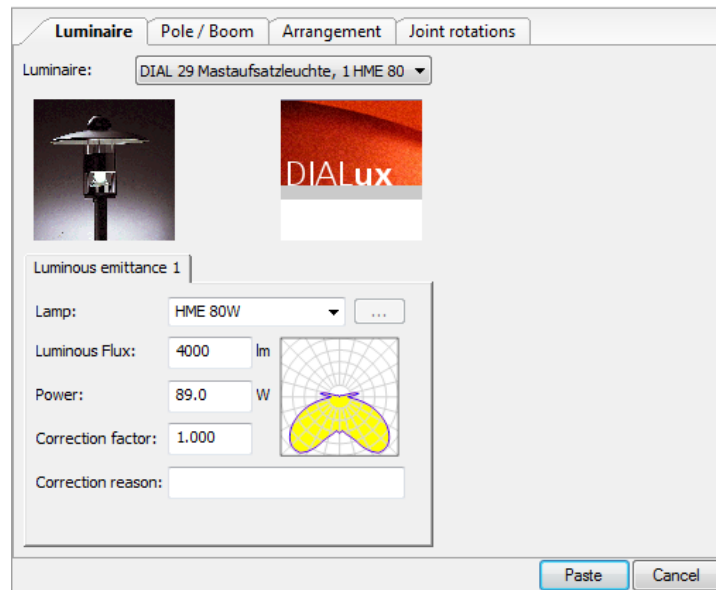

Fig. 383 Insert Street Arrangement – Luminaire

The *Property Page “Luminaire”* allows you to choose the luminaires, as well as the entry of *technical data* of the *luminous emittance*.

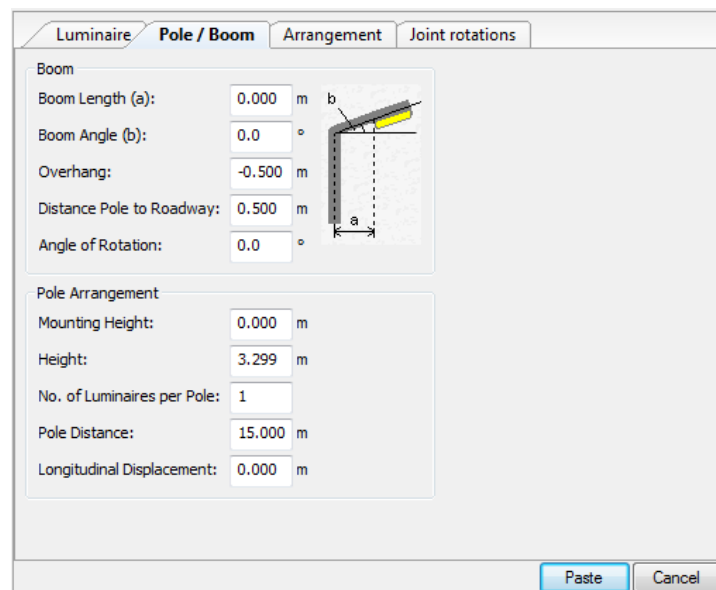

Fig. 384 Insert Street Arrangement – Boom properties and pole arrangement

In the *Property Page “Pole / Boom”* you can define specific properties of the boom as well as the pole arrangement.

The next figure in the *Property “Page Pole/Boom”* illustrates the *Boom Length* and *Boom Inclination*. The *Overhang* defines how far the middle of the luminaire plane (centre of gravity of the luminaire) overlaps the roadway. The *Pole Distance to Roadway* is measured between the root point of the pole and the border of the

roadway. Additionally you can specify the *Pole Arrangement* here.

Under property page *Arrangement* you can define the place along the street where you want to install the luminaires. A list of arrangement types is available to you.

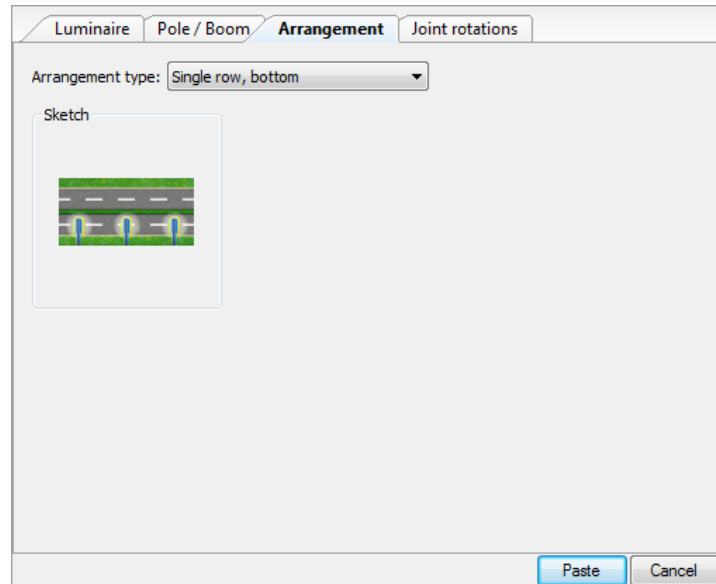

Fig. 385 Insert Street Arrangement – Arrangement

To insert the luminaire arrangement in your street project, please, click on the *Paste* button.

In the context menu of the street arrangement you can optimise individually the arrangement of your luminaires. To do this select with the right mouse button the *street arrangement* in the *Project manager*.

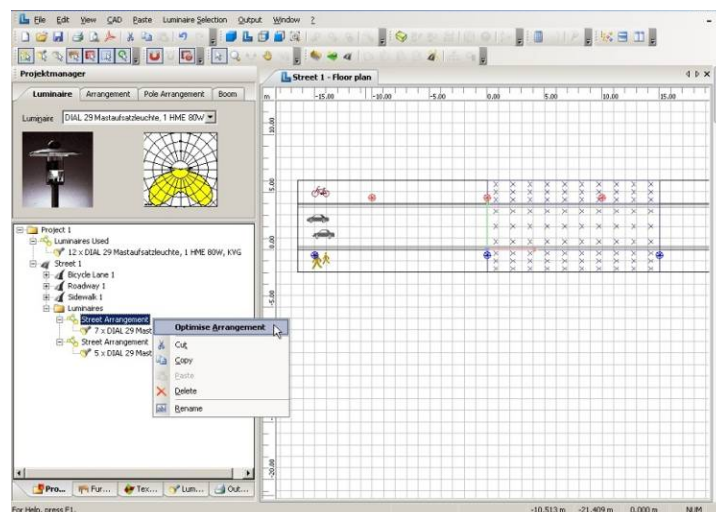

Fig. 386 Street arrangement – Optimise arrangement

The luminaire arrangement always defines the valuation field. If you insert several luminaire arrangements, the

resulting valuation field depends on each case of the maximum (pole) distance between two luminaires, shown in the following example. The luminaires of the lower arrangement therefore specify the calculation field.

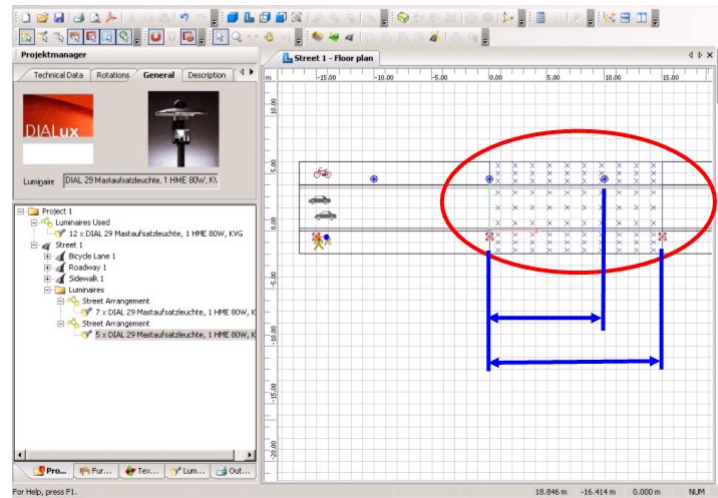

Fig. 387 Calculation field in the ground plan view

The starting point of the arrangement, relatively to the calculation field can be changed under *Pole Arrangement* → *Longitudinal*.

The *Inspector* provides technical data on the inserted luminaire arrangement (see chapter *Luminaire Arrangement*).

DIALux displays the street in 2D and in 3D view just like rooms and exterior scenes.

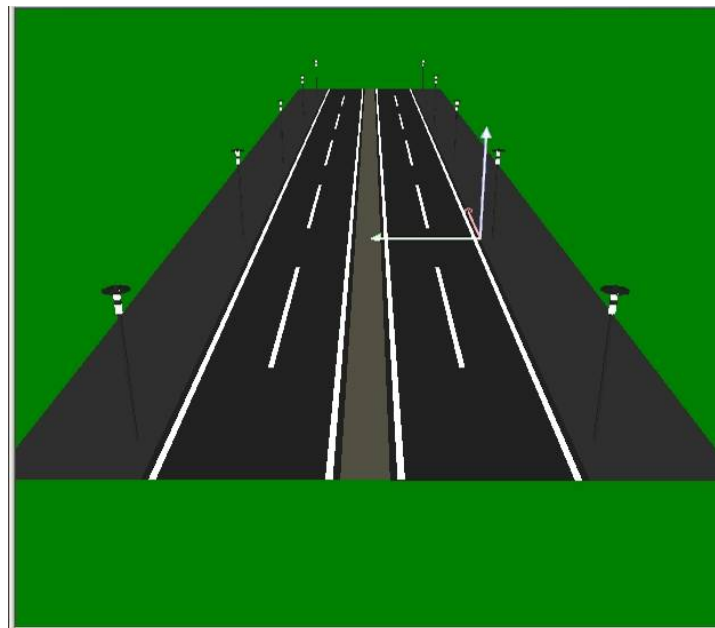

Fig. 388 3D visualisation of the street

You can rotate, zoom and roam the 3D view and export it as *.jpg like all other scenes.

NOTE: The rendering shows the distribution of the illuminance but not the luminance.

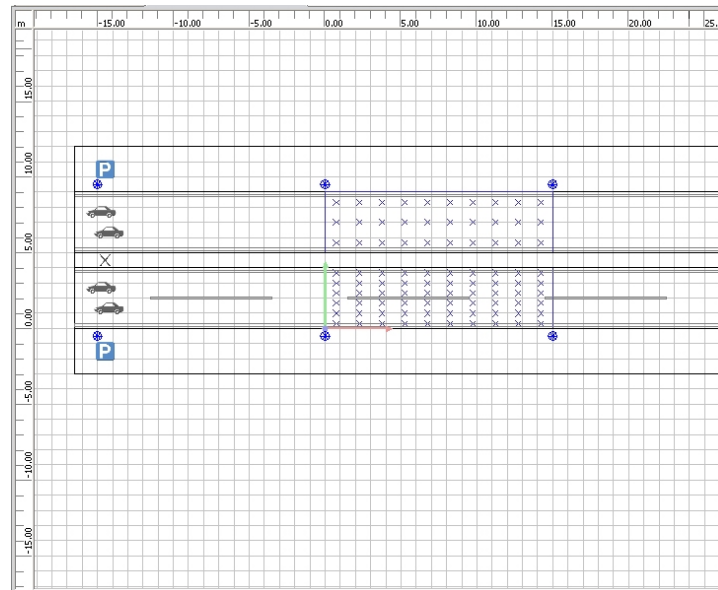

Fig. 389 2D visualisation of the street

In the floor plan view DIALux also shows the valuation field / calculation grid together with the street elements and luminaires.

DIALux offers the option to insert streets into exterior scenes.

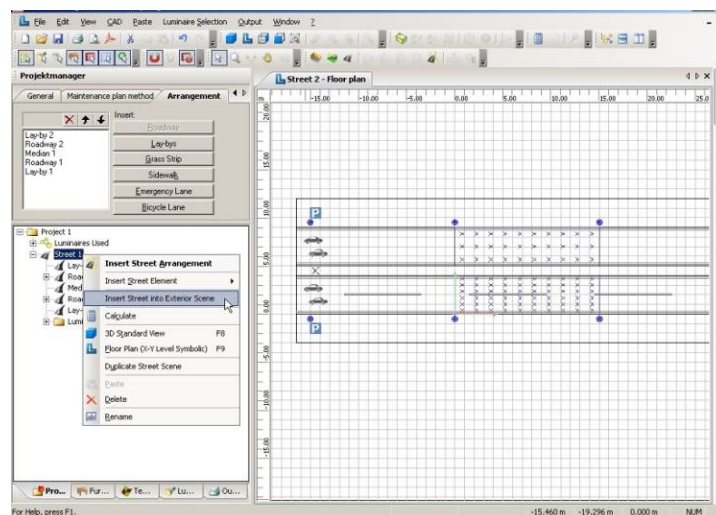

Fig. 390 Insert street into exterior scene

You can work on the individual street elements and luminaire arrangements in the same way as you did in your street project. All street elements are shown in the exterior scene as ground elements.

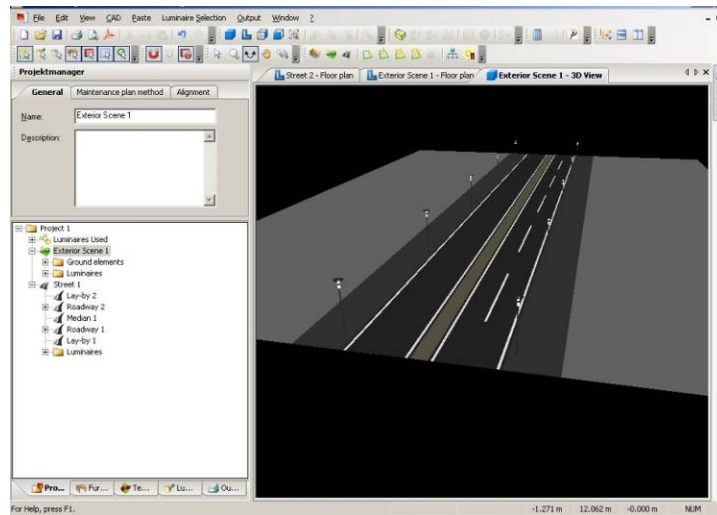

Fig. 391 Street in an exterior scene

Quick Street Planning Wizard

Click with the left mouse button on DIALux Wizards in the WELCOME window in order to use this wizard.

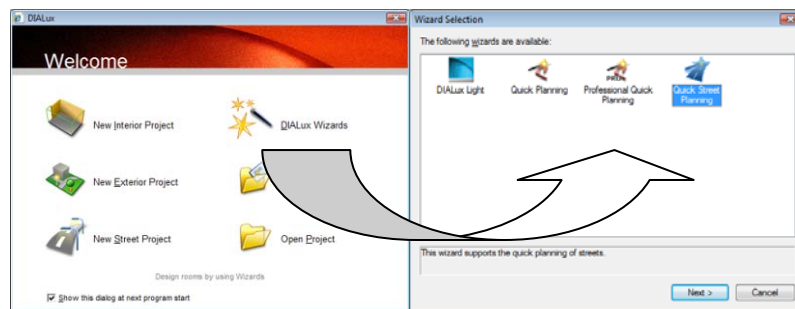

Fig. 392 DIALux wizards – Quick street-planning wizard

If you do not see the WELCOME dialogue any more, you will find the wizards in the menu *File* → *Wizards*.

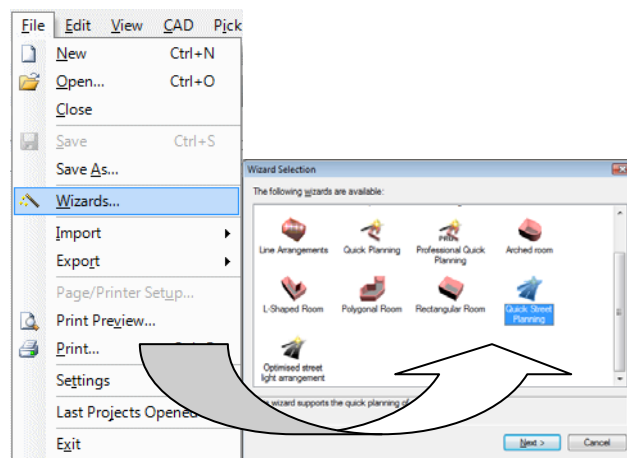

Fig. 393 Wizards via Menu

This wizard guides you through the quick planning for streets.

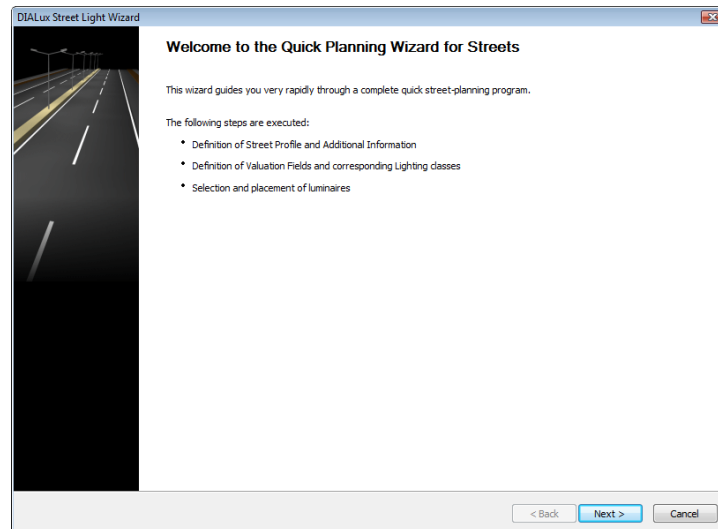

Fig. 394 Startup dialogue for street light wizard

Here you can specify the single elements for the street and their properties. Confirm each of your steps by clicking on *Next*.

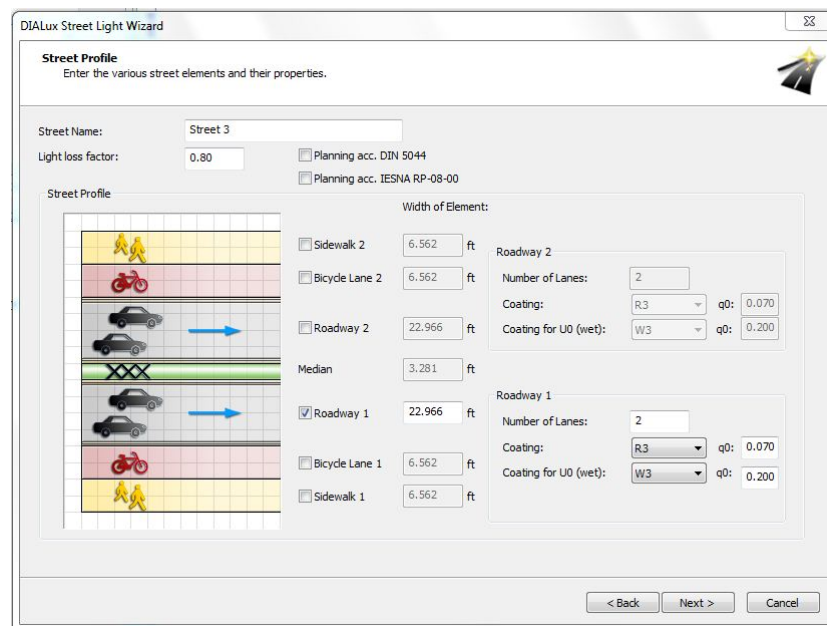

Fig. 395 Street profile

After the start dialog you can select those roadway elements which belong to the street profile of the project. Additionally, it is possible to select the standard. In the wizard the base adjustment is the CIE 140 / EN 13201 standard. The road surface can be chosen for dry and wet surrounding conditions. This is necessary only for the calculation of the same uniformity "U0 wet". Street name and maintenance factor are inserted on this page too.

In the following window you can fix the individual or combined valuation fields for the street. In order to define photometric requirements for the street, select an

illumination class for every valuation field and a method for planning with the IESNA RP-08-00.

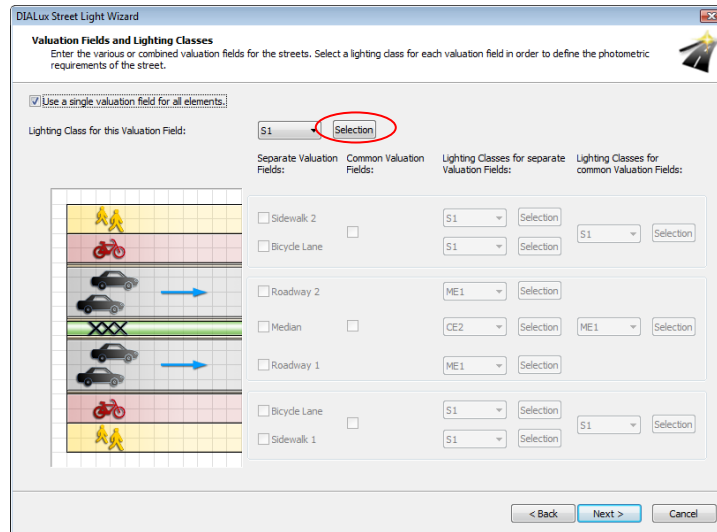

Fig. 396 Valuation Fields and Illumination Classes

By using the button "Selection", the illumination class wizard can be started. To understand this see also the section *Illumination class Wizard according to CIE 140 / EN 13201*.

You can also select single valuation fields and illumination classes for each element.

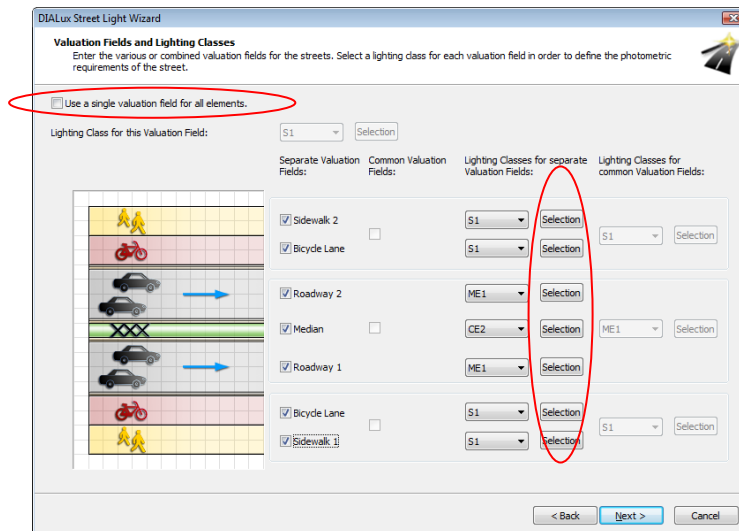

Fig. 397 Valuation Fields and Illumination Classes

In the window *Valuation field* you can select a valuation field for the optimisation, i.e. you define the photometrical data as basis for the optimisation. You can change the respective limit values via left-click on the numbers.

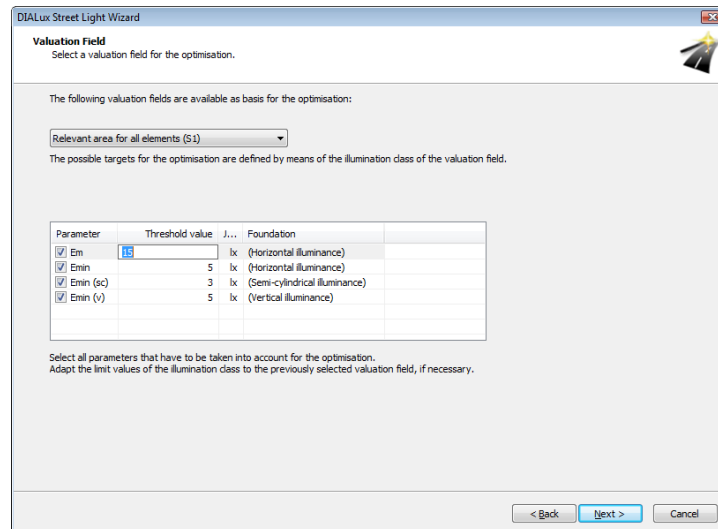

Fig. 398 Limit values for the optimisation

DIALux provides you with the street arrangement adapted to the parameters selected. However, under circumstances according to selected parameters or used luminaires no arrangement which fulfils all limit values can be found. On the window *Substitute list* you can specify the lower limit values. Thus it is possible to sort all arrangement variants into three classes (suitable, largely suitable and inadequate). Without a substitute list only suitable and inadequate arrangements are possible.

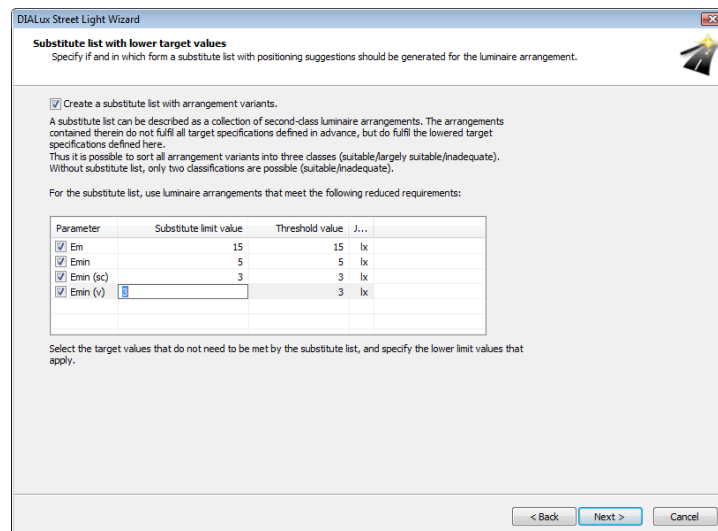

Fig. 399 Substitute list

The next window you have to choose a luminaire via the button "catalogues". You can add several luminaires from *DIALux catalogues*, from *online catalogues*, from *several luminaire files* and your *own database*. The several luminaires are stored in a folder of your computer.

After importing the luminaires, they will be taken automatically into the list of the "Selected luminaires". All luminaires in the list will be included in the calculation

process. Via *double-click* or via the buttons “*Select*” and “*Delete*” you can switch the luminaires between the windows Selected luminaires and recently used luminaires. The luminaires in the list of the recently used luminaires are not used in the calculation process.

DIALux Version 4.9 gives the user the possibility to modify the luminous of each luminaire in the list Selected luminaires.

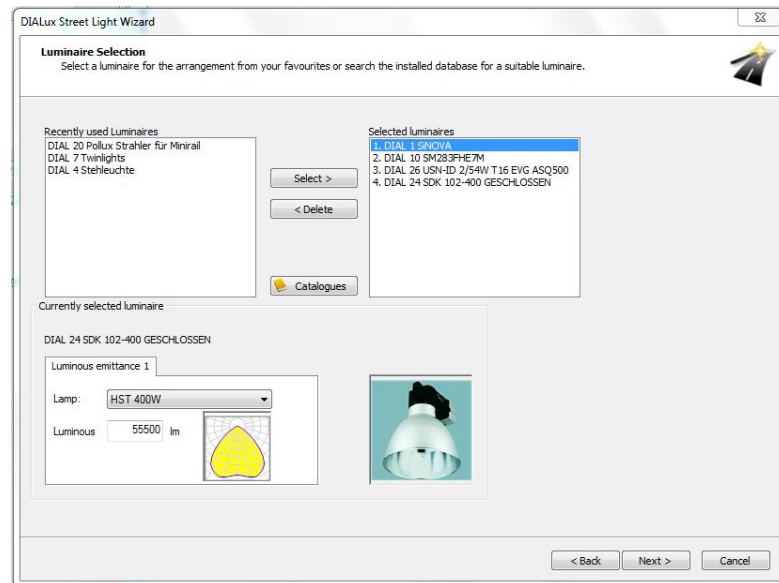

Fig. 400 Luminaire selection

At last you can specify the parameters for the arrangement to be optimised, like pole distance, height above working plane or light overhang. Furthermore, the restriction for inclination of the luminaires is reserved. With immediate effect you can assign each luminaire an inclination. If there are parameters, that are not variable, you can edit the values of fixed parameters alike the arrangement type. If you leave this window by clicking on “*Next*” the calculation of the optimal arrangement will be started automatically.

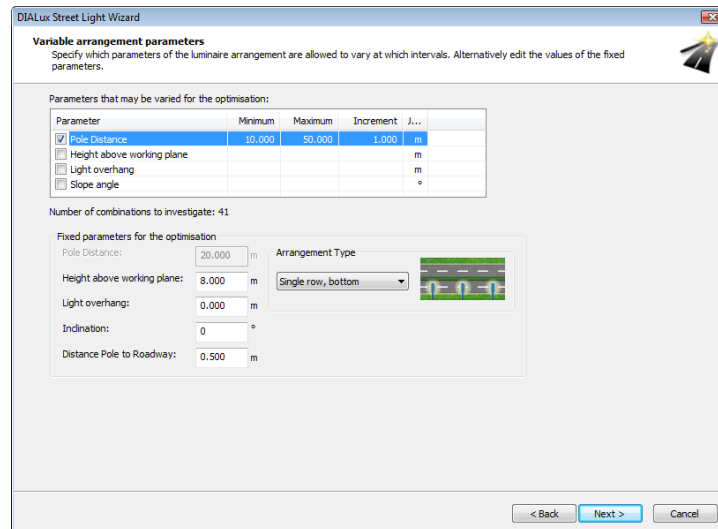

Fig. 401 Variable arrangement parameters

After the calculation DIALux offers you possible positioning suggestions. The suggestions are divided into suitable, largely suitable (incase you have activated the substitute list) and not suitable arrangements. You can open or close these three groups individually via click on *+/-sign* in the list. The results are sorted depending on the single parameters up and down, as clicking on the suitable column header in the result list. DIALux shows you the values of the required parameter in the footer. In order to implement a suggestion, simply select it by clicking on it.

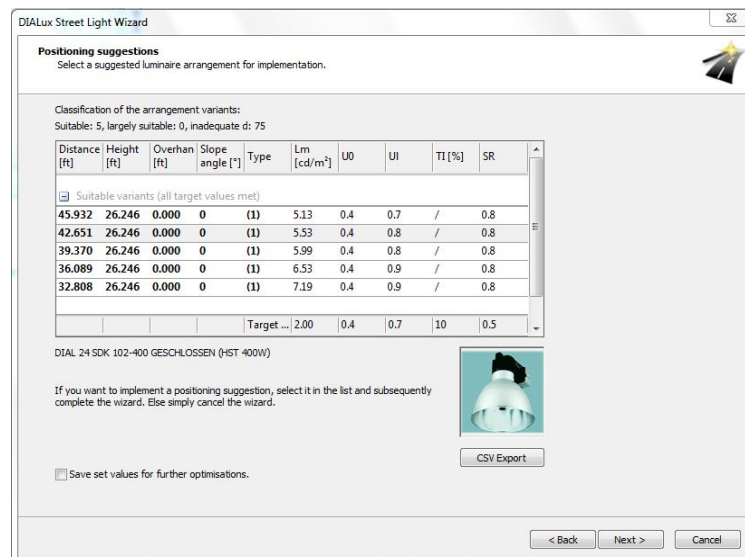

Fig. 402 Positioning suggestions

A new function in DIALux 4.9 is the *CSV export* and the save settings for *Quick Street Planning wizard* and *Optimised Street Light Arrangement wizard*.

To start a *CSV export* click onto the button "*CSV Export*" in the window *Positioning suggestion*.

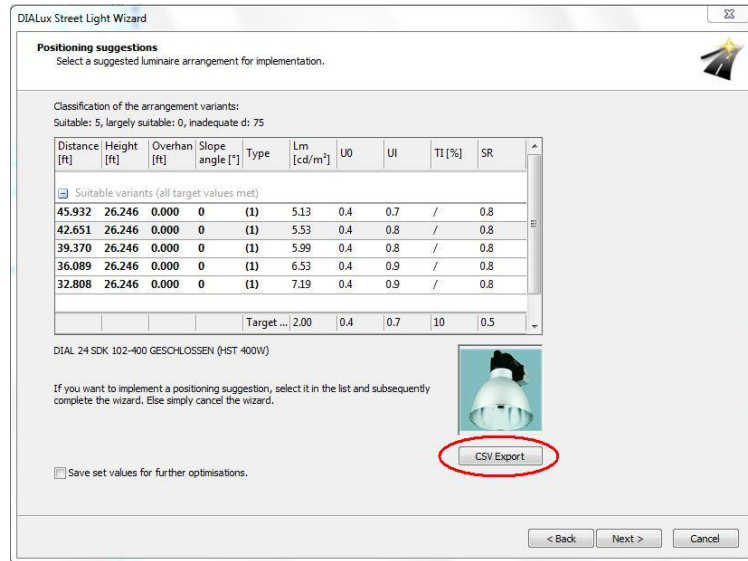

Fig. 403 CSV Export

It will be generated a table by exporting a *csv file*. You can save this table as *.csv at your computer. You can open this file in all programmes including a *table function*. This table includes all arrangement variants with all *adjusted parameters* which have already been calculated by DIALux.

You can save the adjusted parameters via setting the check box "*Save set values for further optimisations*" in the window "*Positioning suggestions*".

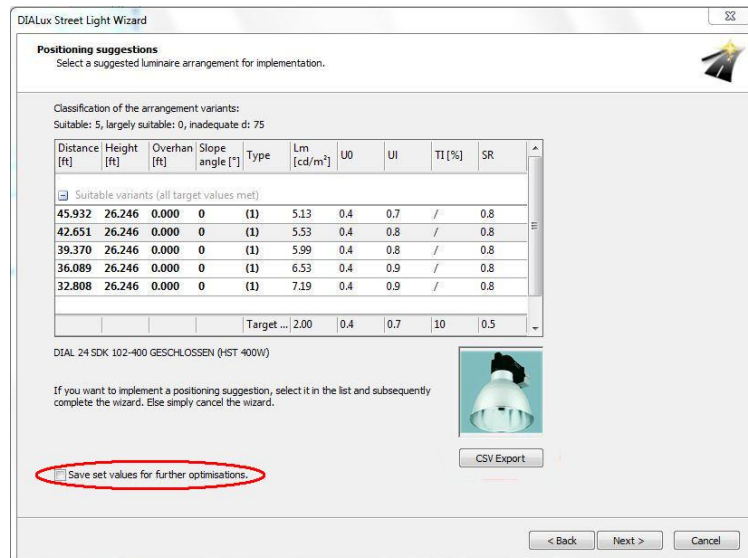

Fig. 404 Saving all adjusted parameters

All settings from your luminaire configuration will be saved. You can use this saved configuration in the *Optimised Street Light Arrangement Wizard* (see chapter *Optimised Street Light Arrangement Wizard*). Accordingly you can calculate a new project with the

same luminaire configuration. It is no longer necessary to edit the same set values in a new project again.

The specifications will only be deleted if you click onto the button "*Delete*". If you save set values again you overwrite the last saved set values. Even if you start DIALux again the set values are still available.

Afterwards a final dialogue will appear automatically. If you activate the checkbox, the generated street will be calculated immediately.

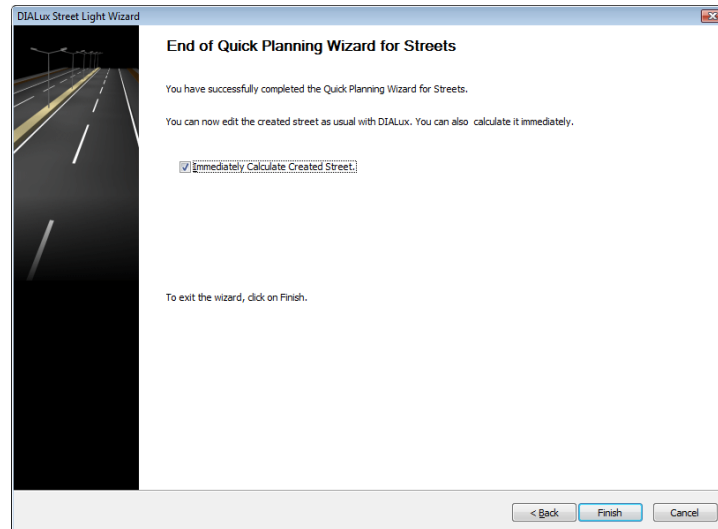

Fig. 405 Final dialogue

Click on the *Finish* button and your street project will be displayed. You can do further work on this later.

Optimised Street Light Arrangement Wizard

You can insert an optimised arrangement also in streets which are already created. For this you can select after planning the street the menu *File* → *Wizards* → "*Optimised street light arrangement*".

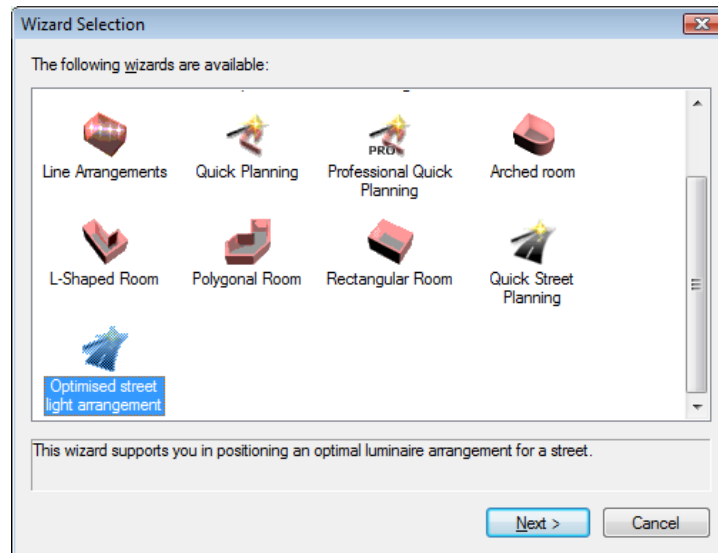

Fig. 406 Wizard Optimised street light arrangement

Alternatively you can open the context menu via right-click on the street in the project tree and select there the menu „Insert optimised luminaire arrangement“.

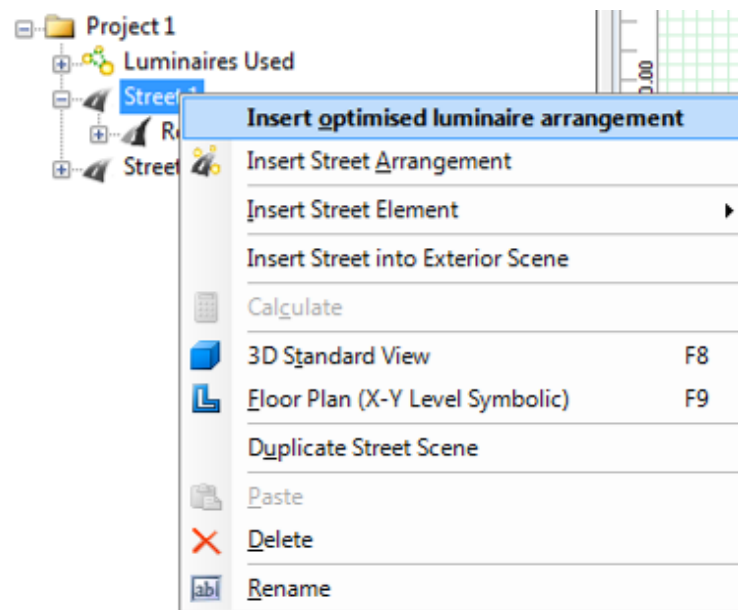

Fig. 407 Context menu luminaire arrangement

Additionally you can start an optimised arrangement via the "The Guide".

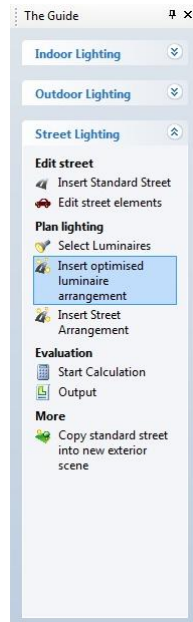

Fig. 408 "The Guide" of optimised luminaire arrangement

In the first window you have the option to load your saved set values, or to configure a new luminaire arrangement. To load the saved set values adjust the check box "*Load value set last*".

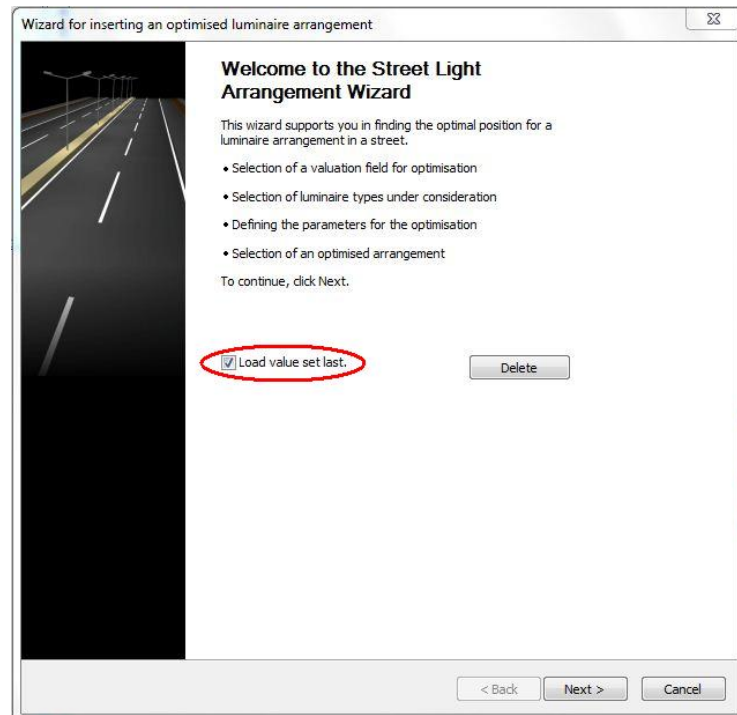

Fig. 409 Load value settings

The setting values will be received until you click onto the button "*Delete*" or save new set values. The new saving will be done according to the *Quick Street Planning Wizard*.

NOTE: DIALux always retains the last saved set value. A new saving overwrites the recent set values.

The optimisation will be done according to the wizard for the quick street planning. The wizard starts in the window "valuation field".

Illumination Conditions Wizard according to CIE 140 / EN 13201

To start the Illumination Conditions Wizard click the button "Wizard" in the Property Page "General" from the inspector of the street.

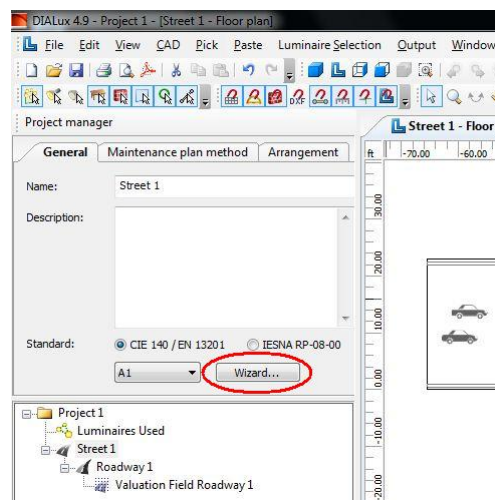

Fig. 410 Start Illumination Conditions Wizard



Fig. 411 Illumination Conditions Wizard – Welcome dialogue

You can set the typical speed of the main user by selecting from four options. Please confirm each of your steps by clicking on *Next*.

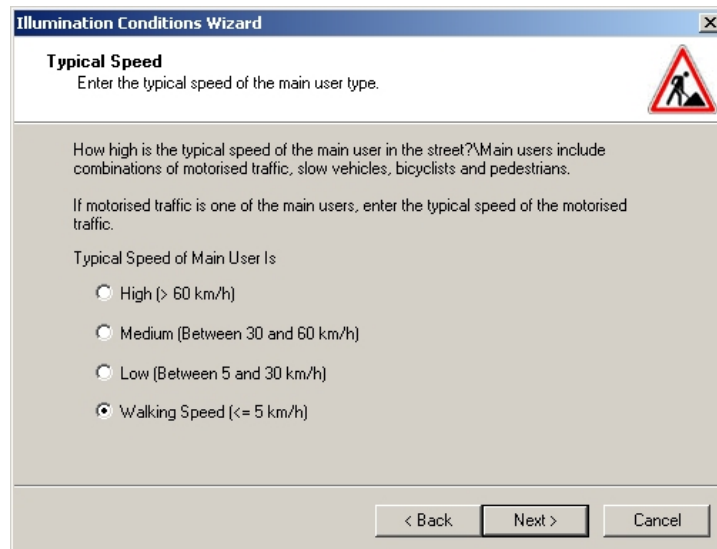

Fig. 412 Illumination Conditions Wizard – Typical Speed

Specify the permitted traffic participants in the window Main Users and Other Users.

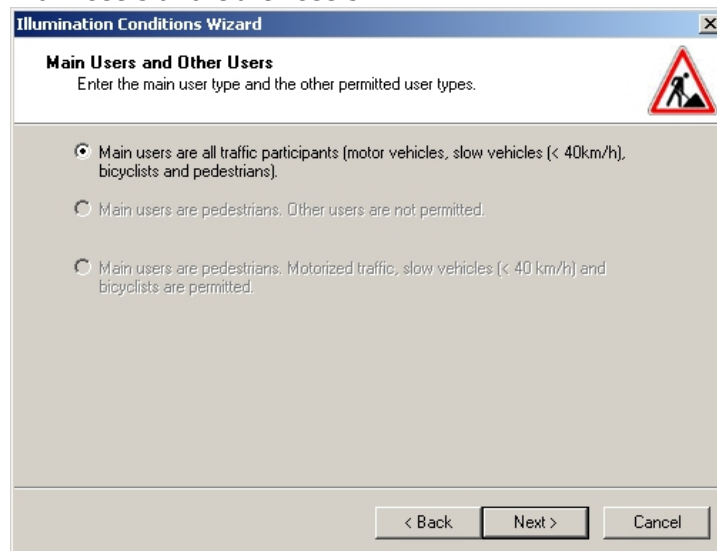

Fig. 413 Illumination Conditions Wizard – Main Users and Other Users

Afterwards a final dialogue appears with the information of the determined illuminance condition.

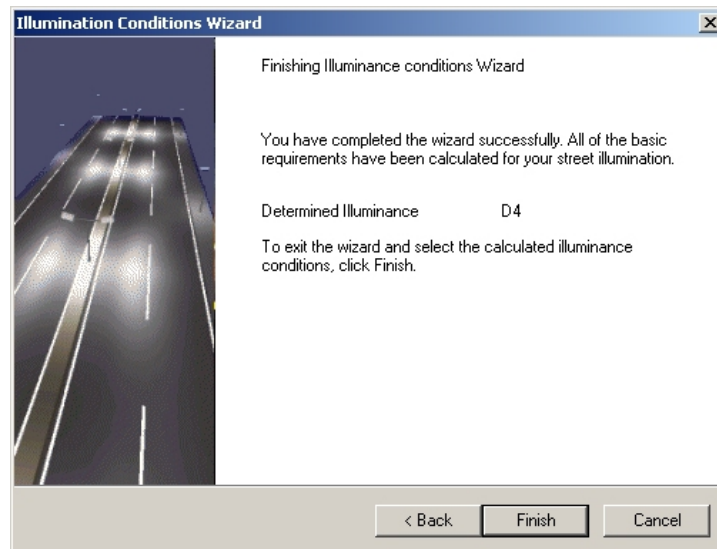

Fig. 414 Illumination Conditions Wizard – Final dialogue

After finishing the wizard DIALux incorporates directly the illuminance condition in your street project.

The wizard has already considered which kind of roadway element you have selected. For example, typical requirements of the roadway do not appear with a sidewalk.

Illumination Class Wizard according to CIE 140 / EN 13201

Click with the left mouse button on the Wizard button from the inspector for the valuation field Roadway to start the Illumination Class Wizard.

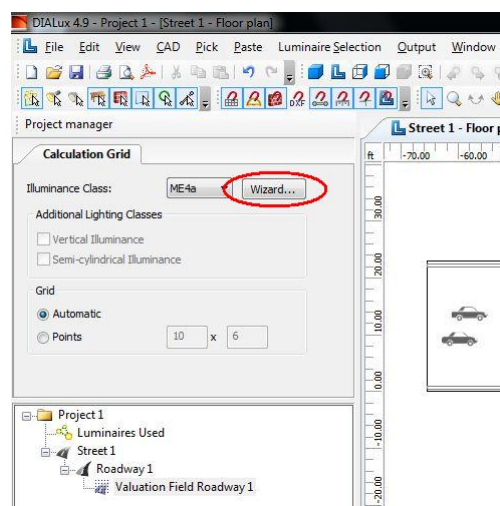

Fig. 415 Start Illumination Class Wizard

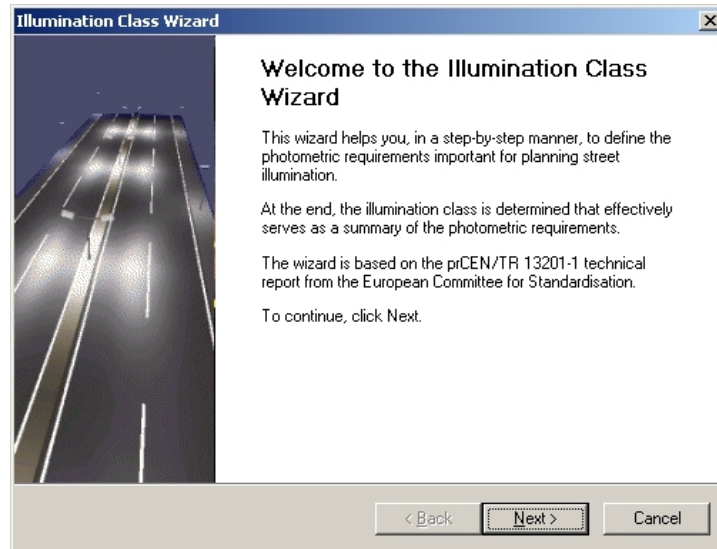

Fig. 416 Illumination Class Wizard – Welcome dialogue

After activating the *Next* button you are called on to specify the typical speed of the main user.



Fig. 417 Illumination Class Wizard – Typical Speed

You can define the admitted main user in the street in the window *Main Users and Other Users*. Confirm each of your steps by clicking on *Next*.

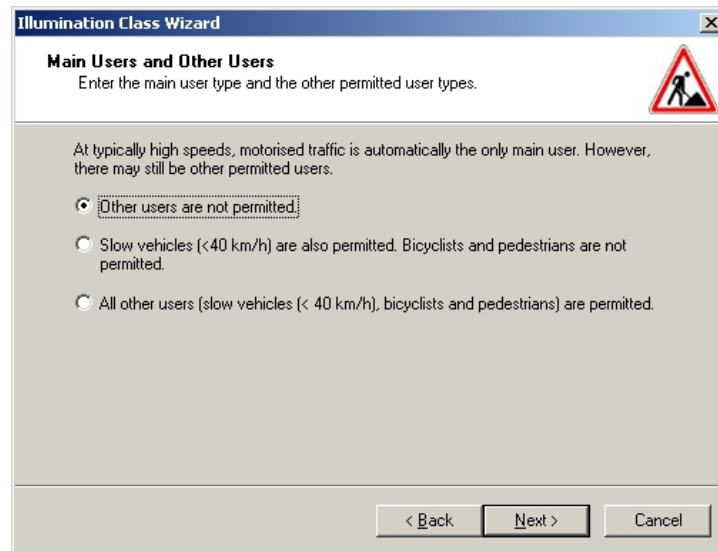

Fig. 418 Illumination Class Wizard – Main Users and Other Users

Afterwards you enter the typical weather.

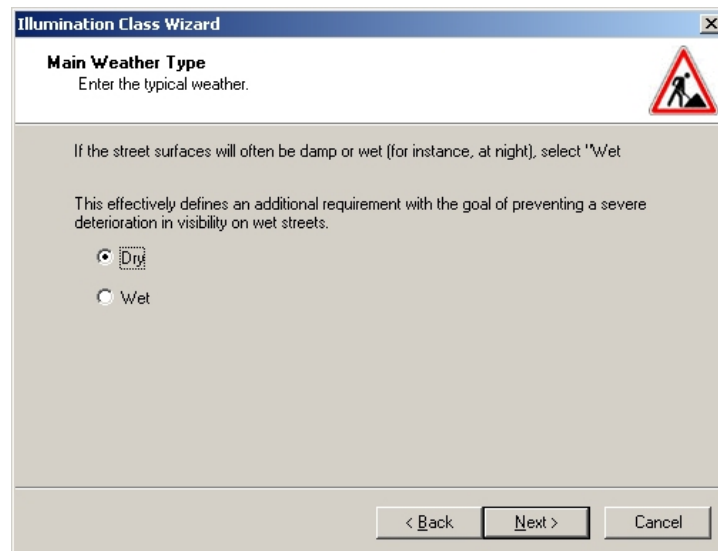

Fig. 419 Illumination Class Wizard – Main Weather Type

In the window *Interchanges* you choose the kind and frequency of the interchanges.

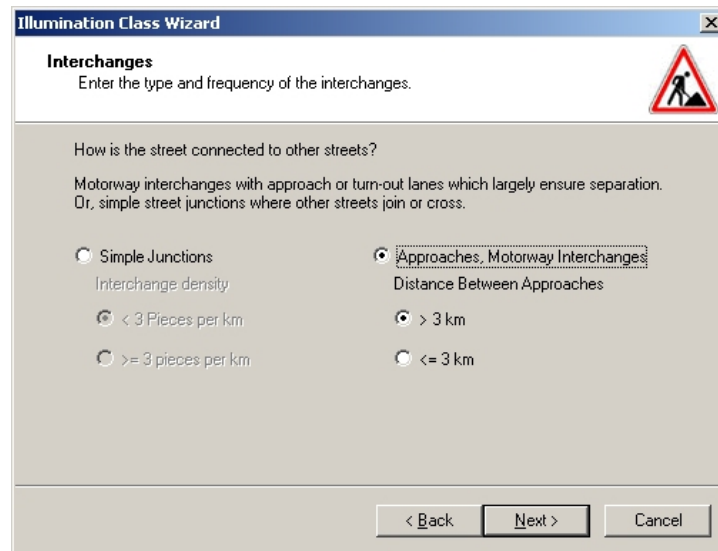

Fig. 420 Illumination Class Wizard – Interchanges

Specify the *traffic flow of motorised vehicles*, if it concerns vehicles for motorised traffic.

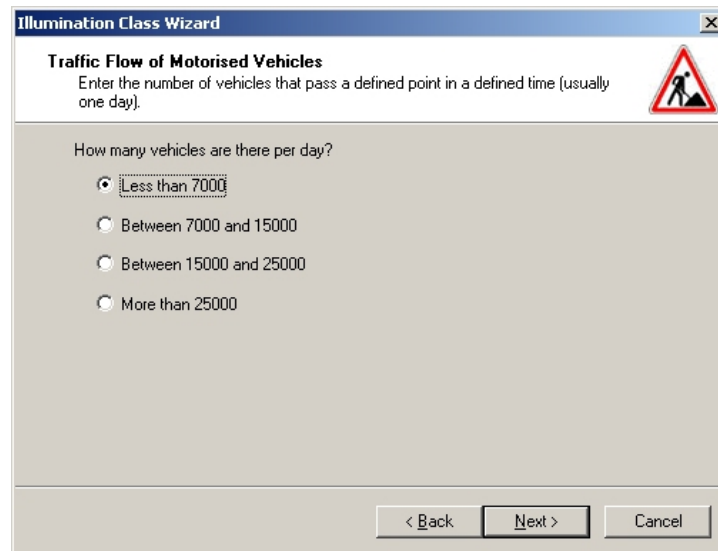

Fig. 421 Illumination Class Wizard – Traffic Flow of Motorised Vehicles

In the window *Conflict Zone* select whether a conflict zone exists or not.

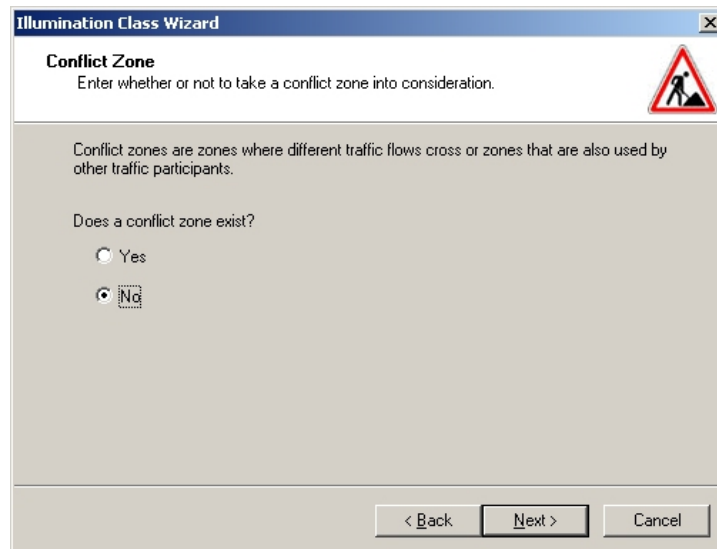

Fig. 422 Illumination Class Wizard – Conflict Zone

Specify the *Complexity of Field of Vision*.

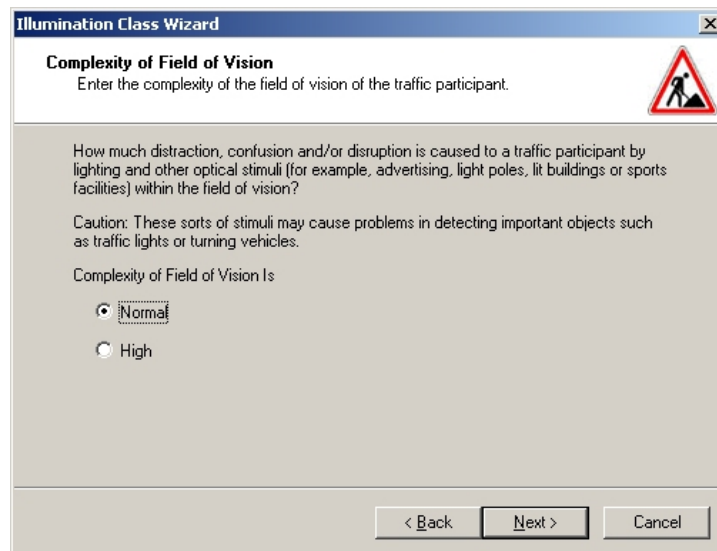

Fig. 423 Illumination Class Wizard – Complexity of Field of Vision

You define the *Degree of Navigational Difficulty* of the traffic participant in the associated window.

Illumination Class Wizard [X]

Degree of Navigational Difficulty
Enter the navigational difficulty of the traffic participant.

How much effort will the traffic participant have to make in order to select a driving direction and driving lane, or to maintain or change their speed and position in the roadway?
This effort results from the displayed information and the optical guidance provided by the street.

Degree of Navigational Difficulty is:

Normal

High

< Back Next > Cancel

Fig. 424 Illumination Class Wizard – Degree of Navigational Difficulty

Afterwards you can select the estimated *Brightness of Surroundings*.

Illumination Class Wizard [X]

Brightness of Surroundings
Enter the estimated luminance level of the environment.

Since the luminance level of the surroundings can only be estimated, only broad classifications are made.

Low (Rural Environment)

Medium (City Environment)

High (Inner-city Environment)

< Back Next > Cancel

Fig. 425 Illumination Class Wizard – Brightness of Surroundings

The wizard indicates to you the determined illumination class in the final dialogue. Upon completion of the wizard the illumination class is automatically taken over in your calculation grid in DIALux.

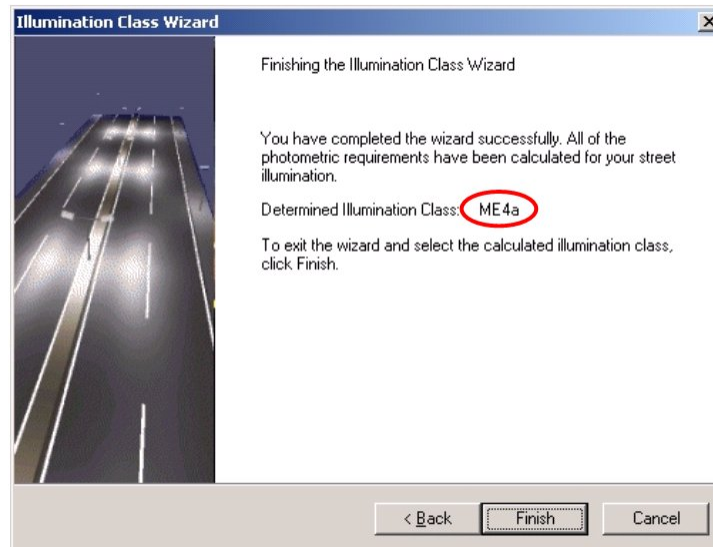

Fig. 426 Illumination Class Wizard – Final dialogue

Importing R-tables

The road surface is an important element of an outdoor scene. Up to version 4.7 it was possible to select a road surface from a collection of standard surfaces.

With DIALux 4.9 it is now possible to add or to import your own R-tables (collection of road surfaces) to DIALux and then use them for planning an outdoor scene.

To do this select "File" → "Import" → "R-table files"

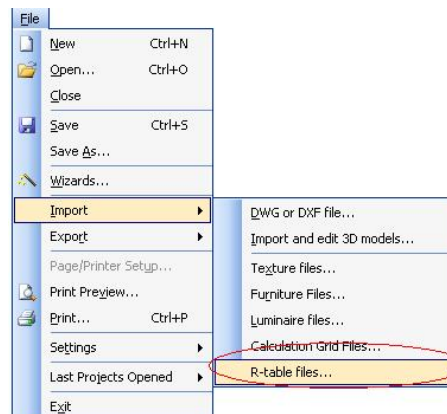

Fig. 427 Importing your own R-table

Now you can select the R-table of choice and insert it into DIALux.

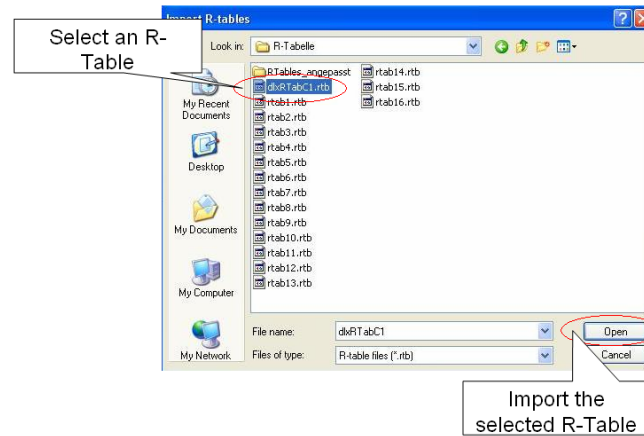

Fig. 428 Selecting an R- table and inserting this in DIALux

R- tables which are already available in DIALux are not imported. DIALux compares the existing R-tables with the new ones and provides an information report about the (negative) result.

The newly inserted R-table can now be selected in the following objects in the road surfaces:

1. Street evaluation field (Inspector of a street scene "Calculation areas" → street calculation field → Street evaluation field → tab "Road surface")
2. New/ existing street project (tab "Road surface")
3. Assistant for quick street planning [Menu "File" → "Assistant" → "Quick street planning" → page 2: Appropriate road(s)]

If you wish to remove an inserted R-table from DIALux then you must delete the corresponding field from the DIALux folder. In Windows XP this is found as a default setting under "Documents and settings\All users\Application data\DIALux\RTables". If you are using Windows Vista you will normally find the R-tables under "Programmes\DIALux\RTables".

Sports complexes

In DIALux 4.9 you can insert sports complexes of different kinds as well as standard roads into an outdoor scene. There are sports complexes for seven different types of sport as well as a general sports complex.

Many different individual functions e.g. inserting a floodlighting arrangement or a TV camera are possible.

Inserting a sports complex

There are many options for inserting a sports complex. First of all you must create an outdoor scene (you will find out how to do this in the chapter "Exterior lighting/ exterior scenes")

Inserting a sports complex or a sports field can be done via the Guide, via the Paste menu or via the tab "Objects" in the DIALux project manager.



Fig. 429 Inserting a sports complex via the guide

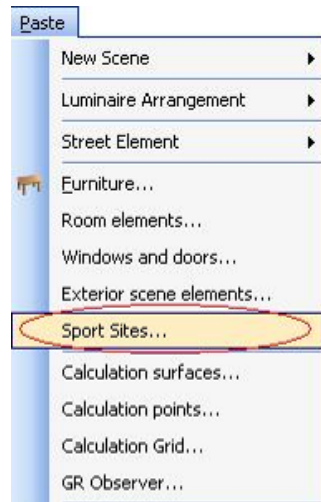

Fig. 430 Inserting a sports complex via the menu

According to your individual requirements, you can now select from a total of eight different sports complexes. Each sports complex has its own symbol and has its own spatial geometry according to the type of sport.

Sport facilities



Fig. 431 Selecting a sports complex

Editing a sports complex

In DIALux, as with rooms or street scenes, you can change the spatial geometry of a sports complex. You can do this either manually in the plan or 3D view or via the project manager. After selecting the sports complex (with a left mouse click on the outer edge) you can make changes e.g. general description, position and size of the sports complex and other settings for marking the sports field. Alternatively changes can be made via the project tree by selecting the sports complex required.

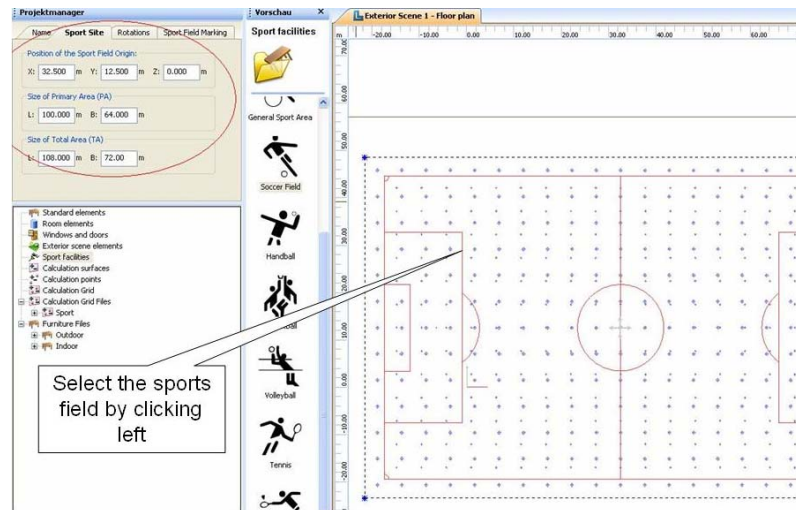

Fig. 432 Opening the project manager for editing a sports complex

After basic editing of the sports complex, you can also insert the sports field elements depending on the type of sport (e.g. two goalposts for a football field). You can do this by clicking with the right mouse button in the project tree on the sports complex (e.g. football field) and then selecting in the context menu which now appears "Insert sports complex elements".

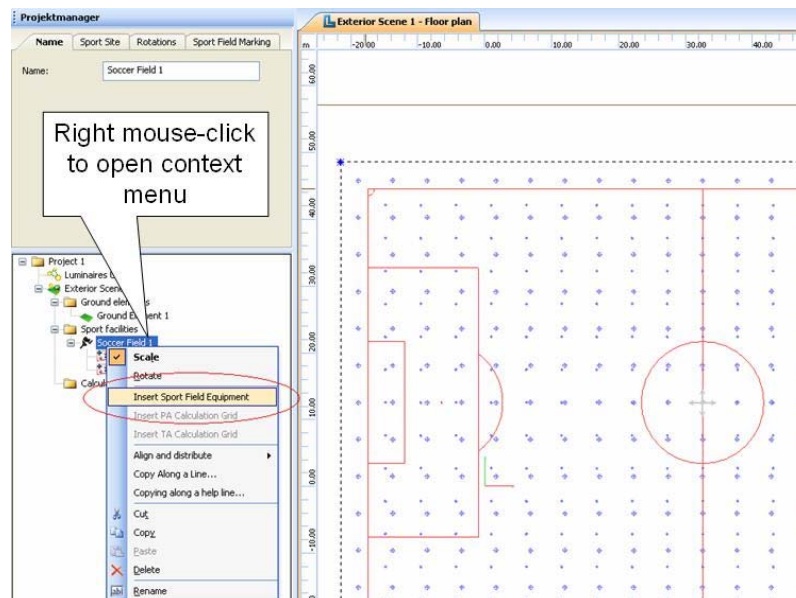

Fig. 433 Inserting sports field elements

Flood light table for sport complex lighting

A new function at the sports complex buildings is the possibility to work with *tables*. It simplifies the positioning of luminaire in sports complex.

To open a flood light table click in the *menu* → *paste* → *luminaire arrangement* → *Guide* for sports complex lighting or choose the corresponding *icon* on the *toolbar*.

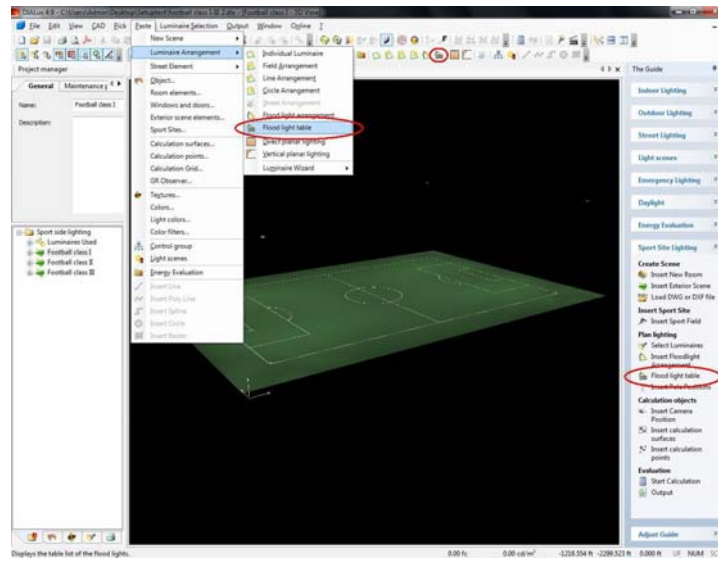

Fig. 434 Start flood light table

With the flood light table it is capable to position and adjust the luminaire arrangements in the project.

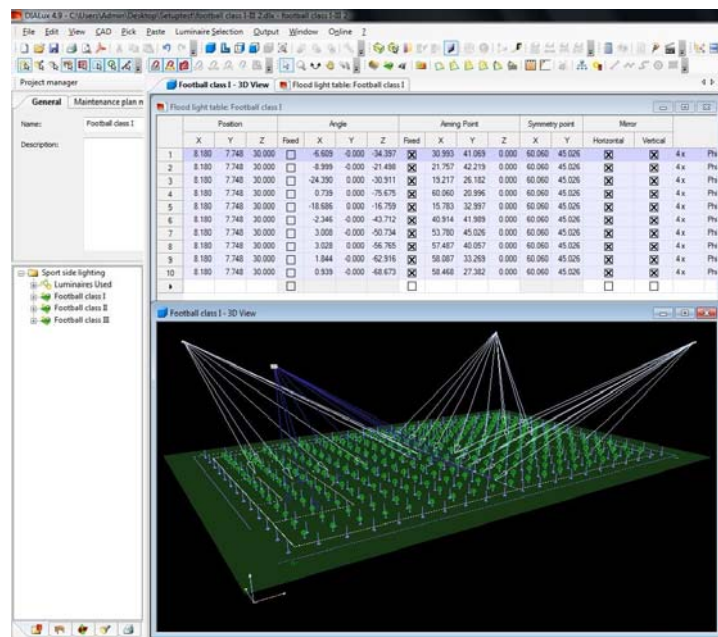

Fig. 435 flood light table for sport complex

You also can insert luminaires to the table. Those can be selected by a drop down list. You can also modify the *rotation* and *luminous flux* of the entry. The delete function works exclusively via the *Del* key. At the table you also can select all luminaires arrangements to arrange together on one *aiming point*.

Initial calculation grids

In a sports complex, depending on the type of sport, there is at least one calculation grid. You can change and adjust these. At this stage it is also possible to insert additional calculation grids. You can find out how to do this and about the settings in the chapter "Calculation grids". All these functionalities can be adapted to sports complexes.

Pole positions

In sports complexes poles can be inserted on which either luminaires or cameras can be mounted. To insert a pole in the project, either click with the left mouse button in the Inspector under sports complexes on the symbol for a pole position and pull this to any position in the project via "drag and drop". The so-called snap-function or catch grid in DIALux makes it even simpler to insert objects. The pole catches automatically onto significant points in the project (e.g. in the corners of sports complexes). Alternatively you can enter the required coordinates in the tab "Geometry" of the pole position.

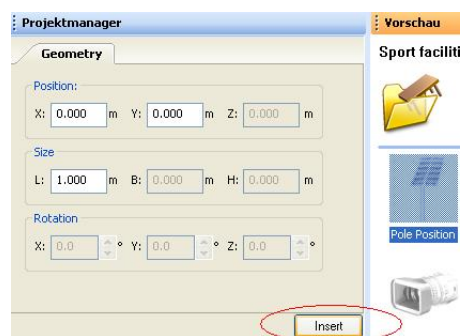

Fig. 436 Inserting a pole position with the Inspector

After inserting a pole you can add further settings to this. The name, the symbol and the geometry can be changed later.

TV cameras

TV cameras are also to be found under sports complexes and can be inserted in exactly the same way as pole positions - either with "Drag and drop" or by entering the geometrical data in the Inspector.

TV cameras can be mounted, for example, on a previously inserted pole position. Just pull the camera to the pole position.

After placing, as with pole positions, it is possible to change the camera name, symbol and geometry.

TV cameras can be rotated and aligned. Do this either by aligning the camera on your own with the mouse or entering the desired angles in the tab "Geometry" in the sub-item "Rotation".

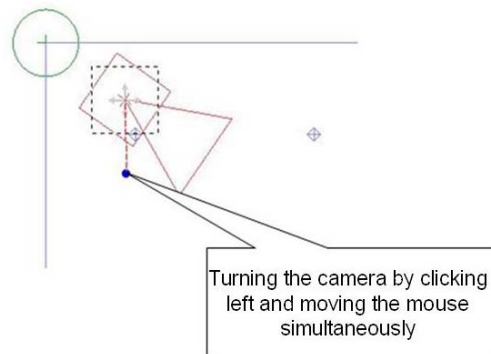

Fig. 437 Aligning a TV camera

Outputs

By default the calculation results for sports complexes are merged and displayed in the outputs. The outputs of a sports complex calculation are in the tab "Outputs" in the project tree. If you have inserted only one outdoor scene and, in this, only one sports complex, then you will find the outputs under ("Project" → "Exterior scene" → "Exterior surfaces" → Your sports complex or its individual calculation grids). Standard outputs include:

- Merging
- Isolines (quantity depends on the number of illuminance values selected)
- Greyscale (quantity depends on the number of illuminance values selected)
- Value chart (quantity depends on the number of illuminance values selected)
- Table (quantity depends on the number of illuminance values selected)

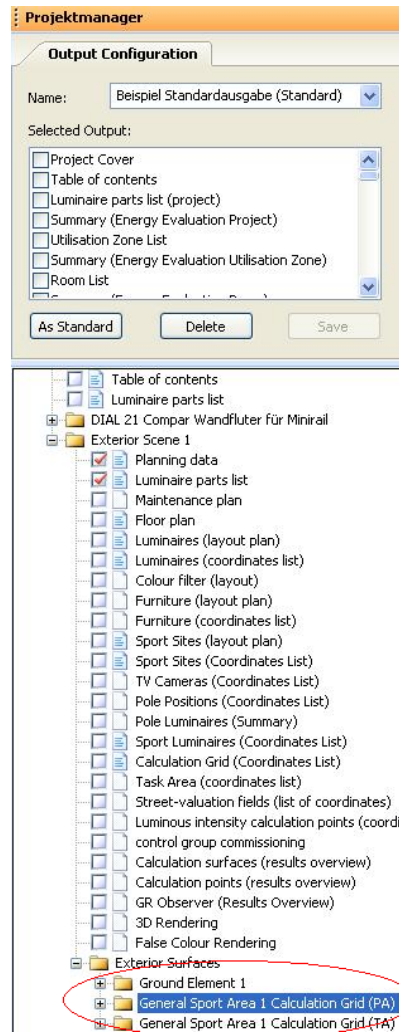

Fig. 438 Example of outputs for a sports complex

You can open the corresponding pages of the output with a double-click on the symbol next to the single output.

For further information please look at the chapter "Output".

Global Output Settings

User Data and Project Data

In the menu *Settings* → *General Options* → *Output* you can define user and project data that are stored as default values. These are used when you create a new project (see also page 54).

In the Property Page *Output* you can specify a *.bmp file as a logo. The footer line is used for page 2 and the following pages. Furthermore you can specify the names of five edit fields that are used later for information on the cover page.

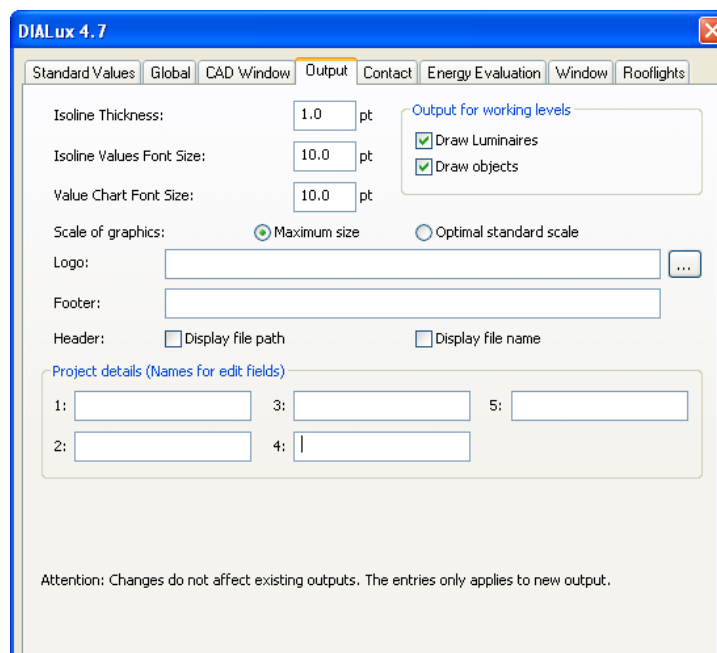

Fig. 439 Output settings

The logo and your user data are shown together on all pages after the cover page.



Fig. 440 Output header line

Global Settings

The Property Page *Global* is used to specify whether you want to use European or American units in your projects.

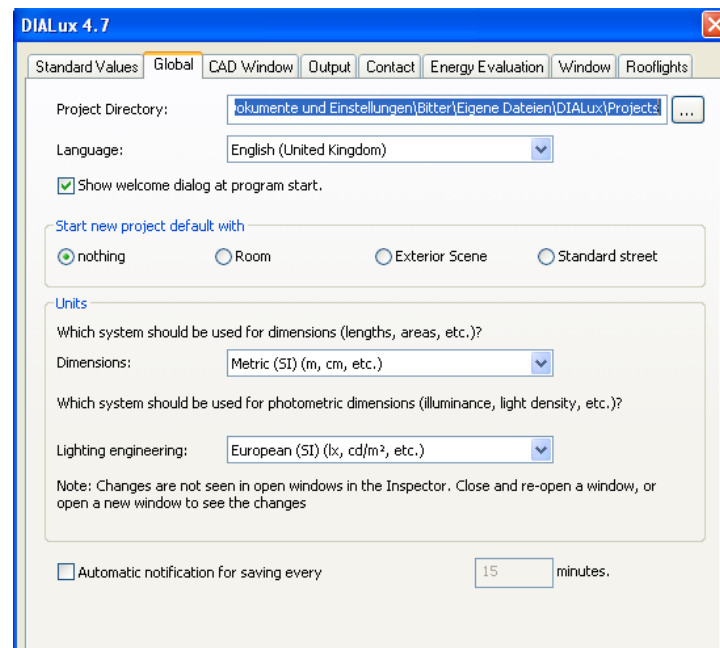

Fig. 441 Global settings

Output

Viewing Calculation Results

After a calculation has been completed, DIALux shows the 3D display of the room.

Project output can be viewed before or after a calculation. The output types which are not affected by the calculation results can be viewed at any time, for example the project cover sheet, luminaire parts lists, luminaire coordinates, room coordinates etc.

Most output types need to be calculated first. If one of these output types is opened when there are no results yet, DIALux enquires whether the calculation should be performed.

When you double-click on the desired page in the *Project manager*, it is displayed in the CAD window. DIALux differentiates between print output and monitor output. The monitor output enables experts to easily evaluate only the required information, without being limited by layout and page size. Big tables are displayed completely and can be viewed by scrolling. Here it is handy to use the middle mouse button.

0.984	365	365	389	389	397	397	418	418	450	450	467	4
0.928	365	365	389	389	397	397	418	418	450	450	467	4
0.872	332	332	355	355	372	372	393	393	421	421	438	4
0.816	332	332	355	355	372	372	393	393	421	421	438	4
0.759	314	314	336	336	351	351	370	370	397	397	412	4
0.703	314	314	336	336	351	351	370	370	397	397	412	4
0.647	279	279	297	297	310	310	326	326	350	350	362	3
0.591	279	279	297	297	310	310	326	326	350	350	362	3
0.534	235	235	247	247	255	255	266	266	286	286	295	2
0.478	235	235	247	247	255	255	266	266	286	286	295	2
0.422	166	166	173	173	180	180	186	186	203	203	208	2
0.366	166	166	173	173	180	180	186	186	203	203	208	2
0.309	132	132	134	134	138	138	140	140	154	154	156	1
0.253	132	132	134	134	138	138	140	140	154	154	156	1
0.197	125	125	126	126	126	126	127	127	141	141	142	1
0.141	125	125	126	126	126	126	127	127	141	141	142	1
0.084	116	116	116	116	116	116	117	117	131	131	131	1
0.028	116	116	116	116	116	116	117	117	131	131	131	1
m	0.042	0.127	0.211	0.295	0.380	0.464	0.548	0.633	0.717	0.802	0.886	0.9

Attention: The coordinates refer to the image above. Values in Lux.

Grid: 64 x 64 Points

E_{av} [lx]
596

Fig. 442 Monitor output of a big table

Scroll bars are located at the window edges. If you use the middle mouse button, the scroll icon appears and you can navigate by moving the mouse.

You can use the print preview to view the printout on the monitor before it is printed. DIALux supports

“WYSIWYG, What you see is what you get”. To go to the print preview, use the *File* → *Print Preview* option. Please keep in mind that only the output types that were selected with a black checkmark are included in the print preview and in the printout. Depending on the size of the report, generating the output can take some time. An information window displays the current status.

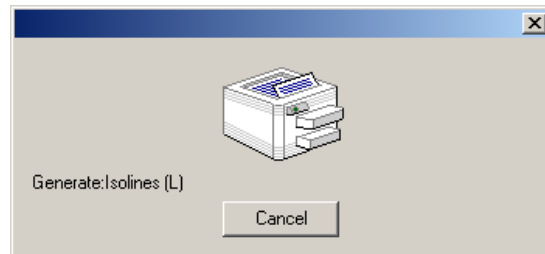

Fig. 443 Print preview generation status

The print preview supplies you with an overview of the chosen output.

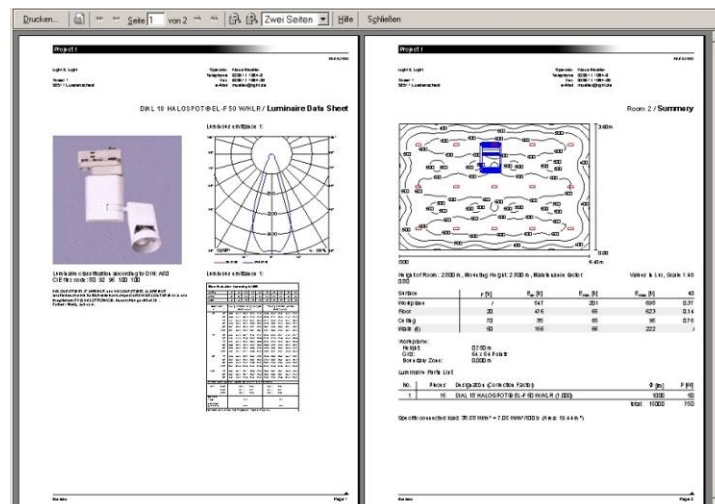

Fig. 444 Print preview

Here you can also specify further print settings, depending on your printer.

For larger print jobs it is advised that you send multiple print jobs consecutively (e.g. Page 1– 30, Page 31- 55). If the RAM is quite large (>128 MB), this is not required.

Limit Result Output

In the *Project manager* you can limit the amount of the output. For example with sloped ceilings there may be results for a number of surfaces that you are not interested in. For all these surfaces you can disable the checkbox *Result Output* so that they will not appear in the output tree.

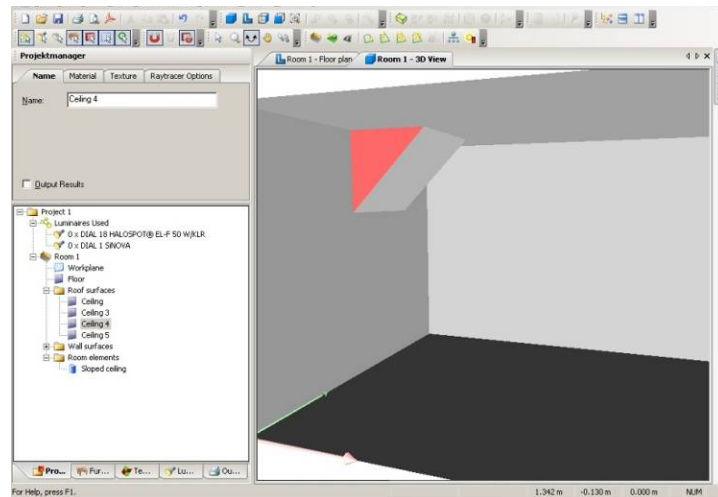

Fig. 445 Limit result output

Output Settings

For many output types further settings can be specified. Select the respective output in the output tree and change the settings in the corresponding Property Page in the *Inspector*.

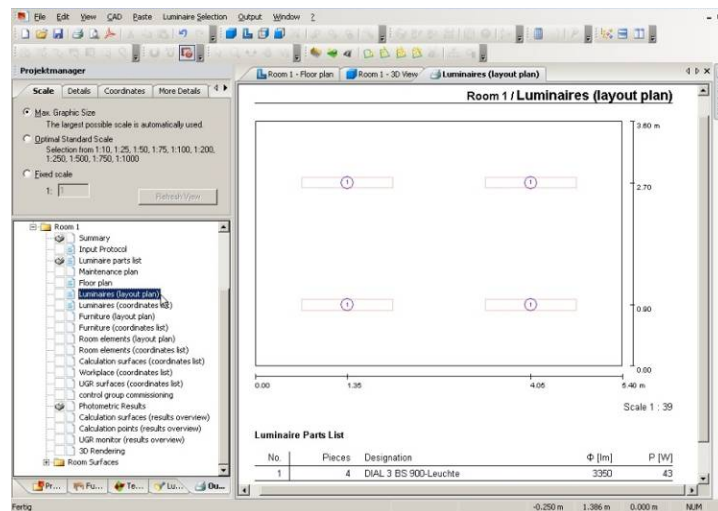

Fig. 446 Output settings

If you change the settings, the *Refresh View* button is activated. If you use this button, the changes entered are applied in the output window.

The 3D rendering is generated using the observer position set in the CAD.

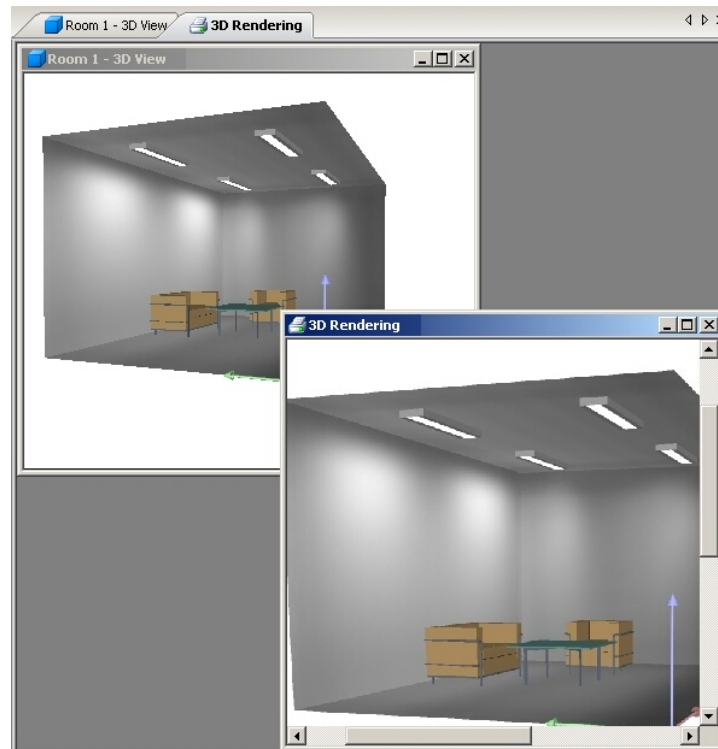

Fig. 447 3D CAD at the top left (for editing purposes) and 3D rendering (as output) at the bottom right

New Output in DIALux

DIALux offers several new or enhanced output types since DIALux 4. Most of them refer to the new light controls. Thus there are suitable outputs for control groups and light scenes. These outputs are similar to the present outputs of other rooms.

Fixing the calculation grid in the output

The calculation grid is fixed in DIALux in the outputs. Open in the output tree the summary of a light scene and select the settings of your output grid. If you click on the "Refresh View" button DIALux determines the current calculation grid and displays the results in the output window.

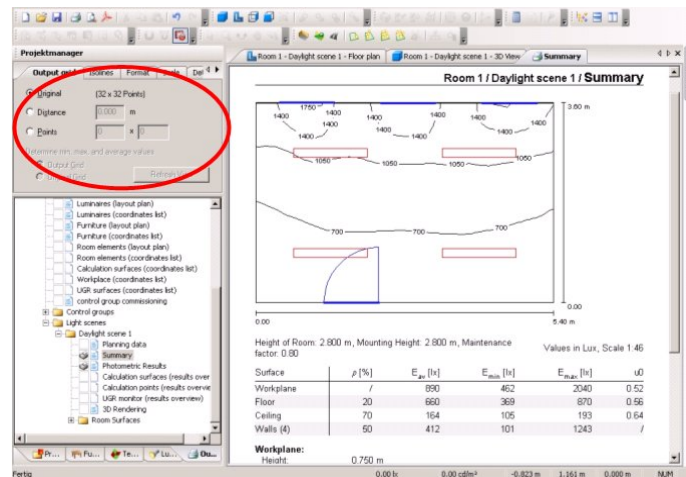

Fig. 448 Output of a light scene

The documentation of the used luminaires is modified in DIALux too.

Luminaire Data Sheet

The design is completely changed. Besides the picture and the text two customisable diagrams are created. When you use luminaires with several light outlets you can select which diagram is used for which outlet. The luminaire can be classified according to numerous regulations (DIN, BZ, UTE, CIE, NBN).

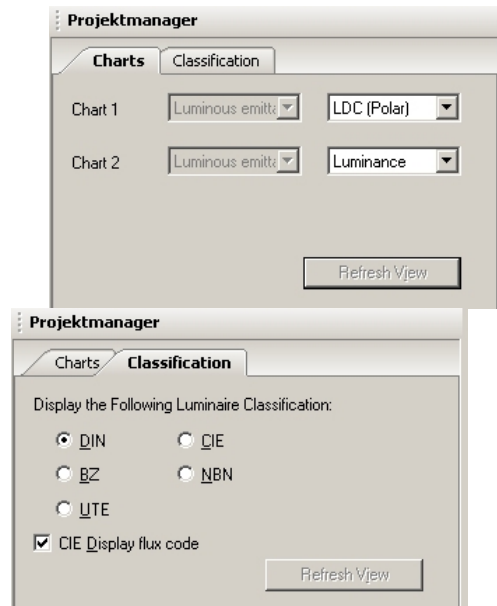

Fig. 449 Settings of luminaire data sheet

Luminance Diagram

The luminance diagram is a new development that allows the evaluation of the luminance with regard to different angles of radiation (omni directional glare control).

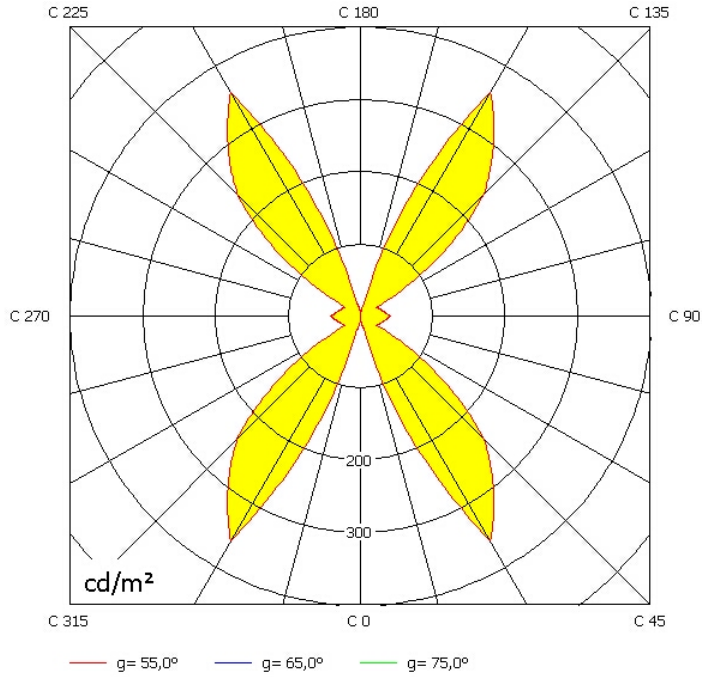

Fig. 450 Luminance diagram for evaluation of omni directional glare control

Tabular Presentation of Photometric Data of Luminaires

The light intensity and the luminance are also presented in tabular form. The steps C-levels and Gamma angles can be adjusted in the Property Page.

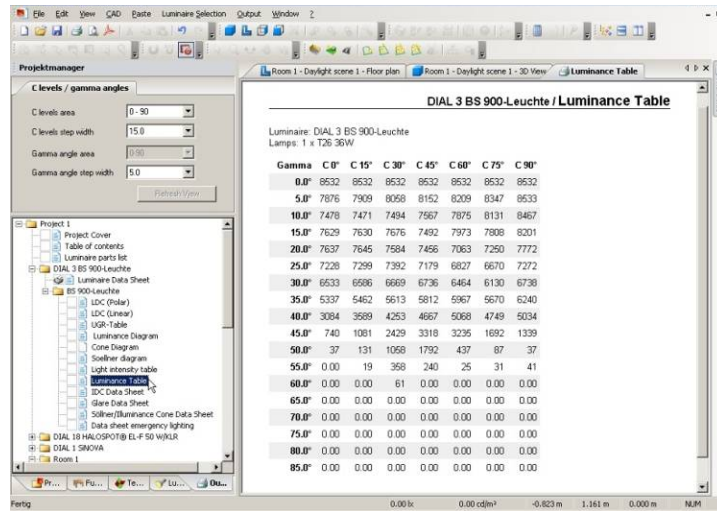

Fig. 451 Light intensity table

Tabular Presentation of Exterior Scenes

DIALux can create a summary which contains a ground plan with luminaires and furniture and their coordinates. With the Property Page you can adjust the scale, details and coordinates.

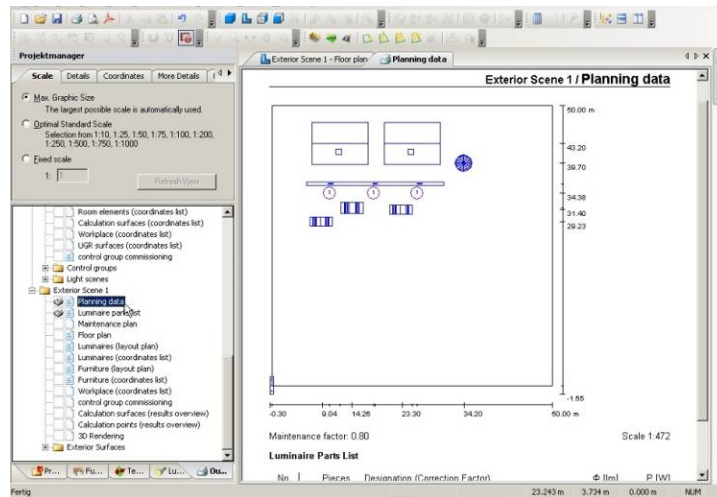

Fig. 452 Property page output exterior scene

Creating User-Defined Standard Output

The user can generate and save frequently-used combinations of output types in DIALux. To do this, a folder that contains output must be selected in the output tree.

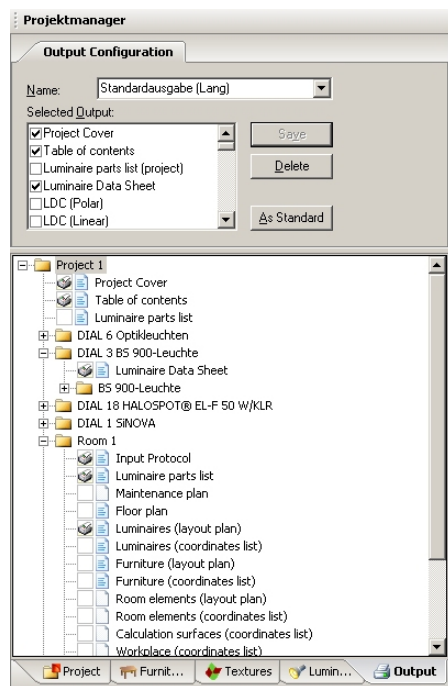

Fig. 453 Creating standard outputs

Start on the highest hierarchy level, i.e. the project. Select the project in the output tree, in this case project 1. If you wish to use a preset standard, select it from the *Name* listbox. To generate a standard, check the output types which should be included in your standard. Please keep in mind that the list contains all output types, including those of lower hierarchy levels. For example, if you check the Isolines (E) output type in this hierarchy level, it is also checked in all lower hierarchical levels.

You can now select lower hierarchical levels and use a different output standard here. For example you can select Room 1 and select the *Complete Documentation* standard, which in this example describes a very extensive documentation. The other rooms are not affected by this change, as these still use the *Short Documentation* output standard which has previously been assigned to the project.

Thus you can influence the individual output subdirectories – thereby deviating from the global standard. Of course you additionally have the option of selecting the output types individually for every object in the output tree.

To use a user-defined output standard as default setting, select it from the *Name* listbox and click on the *As Standard* button. In the listbox the phrase *Standard* appears in brackets behind the corresponding name. To delete a user-defined standard, select it and click on *Delete*. After another standard has been selected from the listbox the one deleted previously is not available anymore.

Save Output as PDF-File

Similar to the printing you also can export the output to a PDF-file. After you selected all desired information with the small printer symbol you select the menu *File* → *Export* → *Save Output as PDF*.

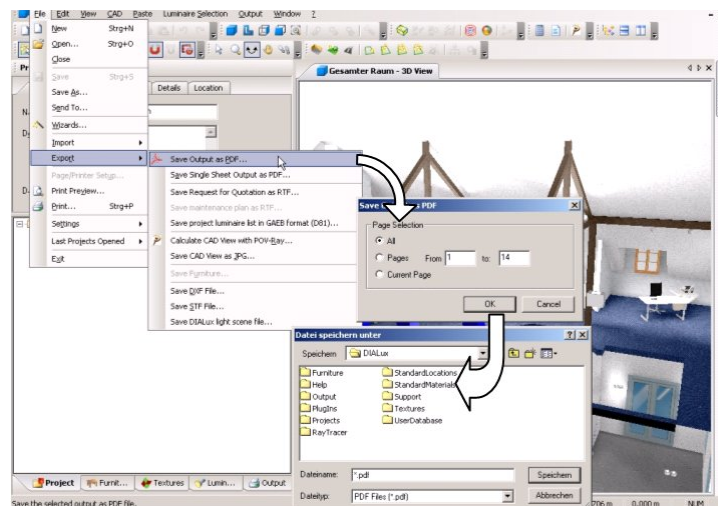

Fig. 454 Export the output to a PDF-file

This menu is only available if one output window is active. Then you are asked to specify the directory and the name of the PDF-file. Exporting to PDF can take some time if you have a large project but usually it is twice as fast as printing the output. Once you have the PDF-file you can send it to your customer. The PDF-file cannot be modified.

Export Output Graphics, tables, text and graphic

When the output in DIALux is opened (double-click on the desired output sheet) any type of output can be selected for copy and paste by a right click on it. Further on tables, graphics and text can be saved in a file.

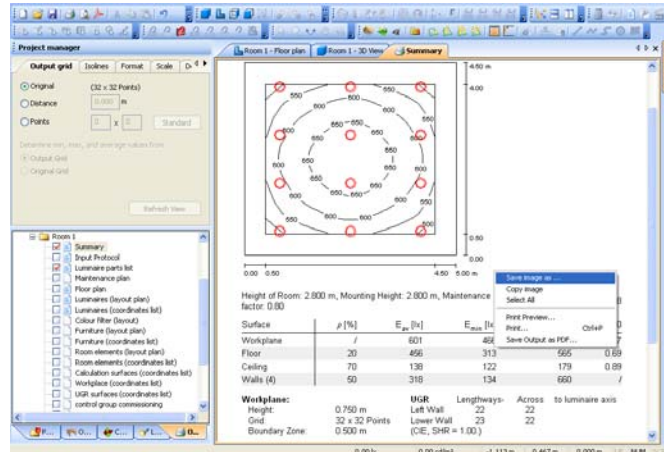

Fig. 455 Export the output table to a file or copy it into the clipboard

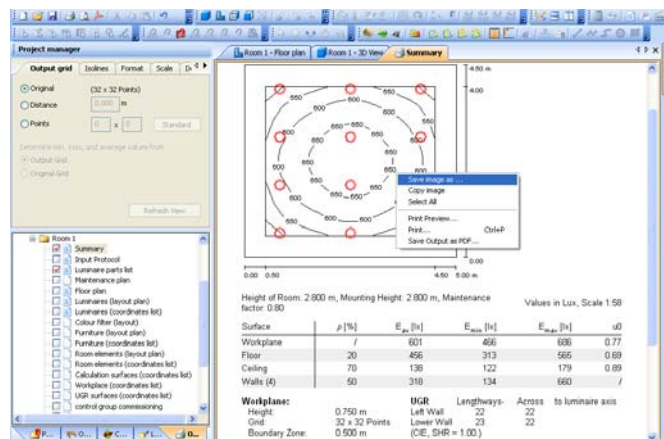

Fig. 456 Export the output graphic to a file or copy it into the clipboard

You can export the graphical output DIALux created to almost all other Windows software like Word or image processing software. To do this open the according output in the output tree and adjust the settings (e.g. steps, colours, font size...). Now click and hold the left mouse button in the output window and drag the output image to the other program. The image is copied to this program as a *.wmf-image.

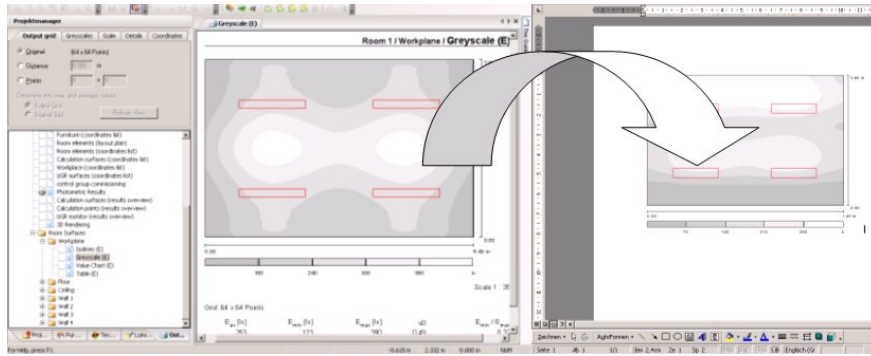

Fig. 457 Export of output graphics to other programmes

Of course you can also copy text and tables to other programs with *Copy* and *Paste*.

DWG and DXF Import and Export

With DIALux you may import DWG and DXF drawings and use them for your work. After you finished your planning you can export the room geometry, the room elements, the luminaires and the furniture into your CAD-drawing.

DWG / DXF-Import

- Create an empty rectangular room (If you work on an exterior scene create that)
- Go to the ground plan view
- From the menu *File Import* use the option *DWG* or *DXF File*. The wizard asks you to select the dwg or dxf-file.



Fig. 458 DWG / DXF Import options

- Let the wizard read the file.
- The units used in the dwg / dxf-file are not yet defined. When you select the probable unit, the size of the drawing is listed in two fields.
- You can place the origin of the planning at the origin of the global coordinates system (0.00/0.00/0.00) or you can choose a point defined in the file or you can place the origin at the gravity centre of the used area (the middle of the drawing).

Basic DWG / DXF Settings and Layer Selection

With the menu *CAD* you can change the properties of the dwg / dxf-file and of the layers similar to the CAD program. You can decide to show or hide single layers and to set the layer colour. If a layer of the dxf-file uses a certain colour you may overwrite this colour.

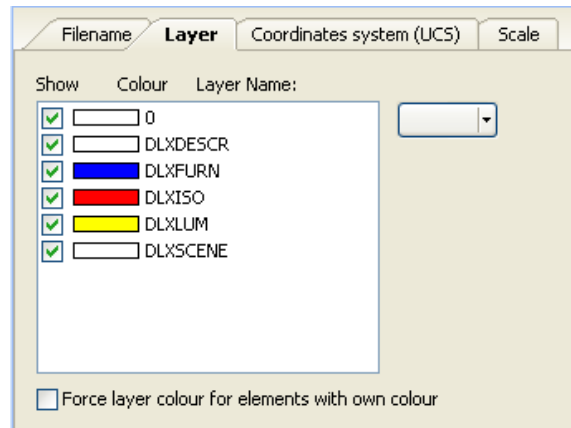

Fig. 459 DWG / DXF settings

Edit a Room based on the DWG / DXF-Ground Plan

To move the room to a certain position of the dwg / dxf-ground plan, just click on this point with the right mouse button, and use the option *Set DWG or DXF-origin here*.

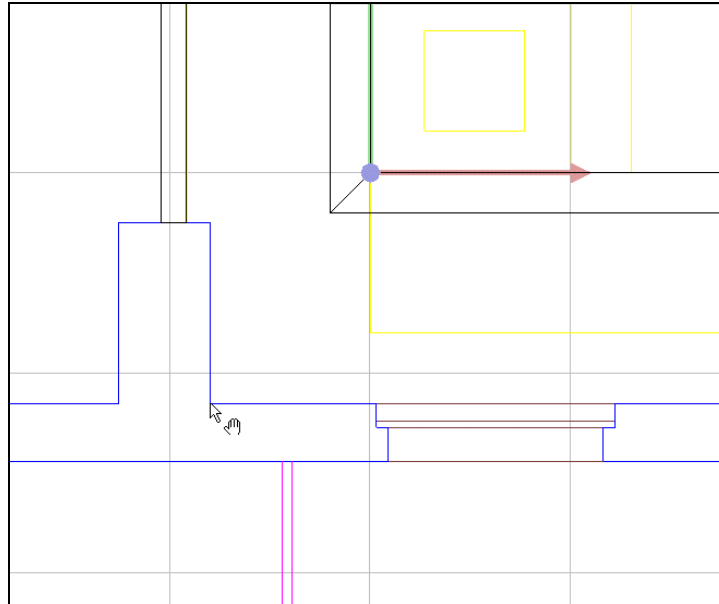

Fig. 460 Move the dwg / dxf-origin with mouse and context menu

After you moved one corner of the room to the origin of the dwg / dxf-drawing, you can adjust the room geometry. The easiest way is to drag the corners of your room after selecting *Edit room geometry* from *The Guide*.

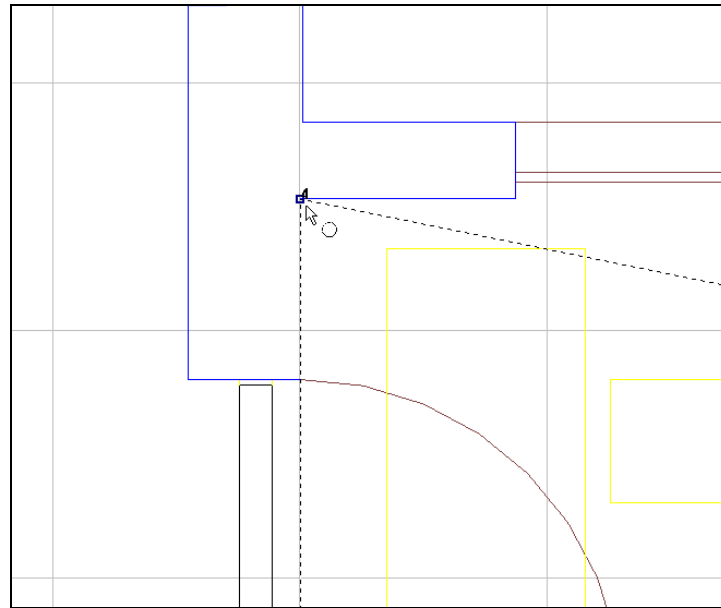

Fig. 461 Drag the corners to align the room with the drawing

Now you can insert further elements like doors and windows based on the drawing.

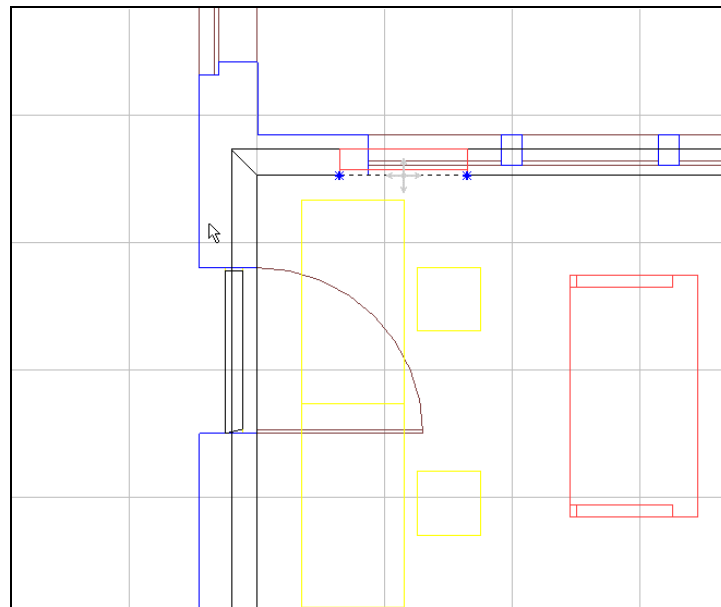

Fig. 462 Insert doors, windows, furniture

Working with the DWG / DXF Background in the 3D View

You can use the CAD-drawing as a background image in the 3D view. Usually it is recommended to use the option *Represent 2D projection of dwg / dxf in 3D view* from the Property Page.

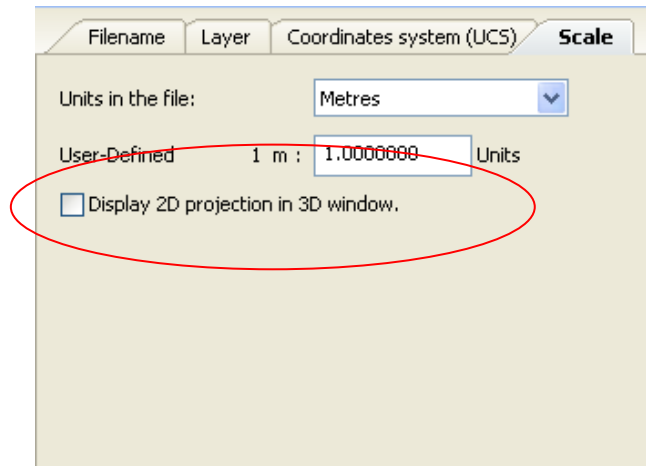

Fig. 463 Using 2D projection of dwg / dxf in 3D view

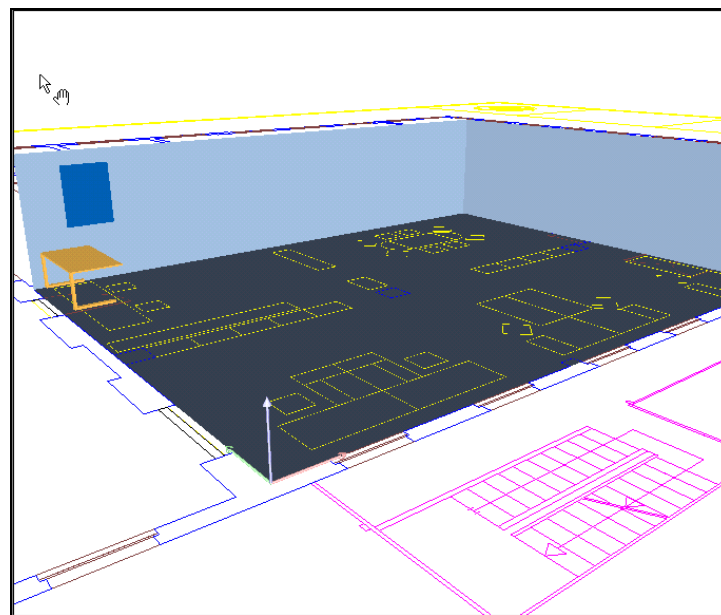

Fig. 464 3D view with DXF background

You can display or hide the dwg / dxf background from the *Window* toolbar.

DWG / DXF-Export

You can export the result of your planning in dwg or dxf-format and specify the file type dwg or dxf in the "Save under" dialogue which you can open via "Search...".

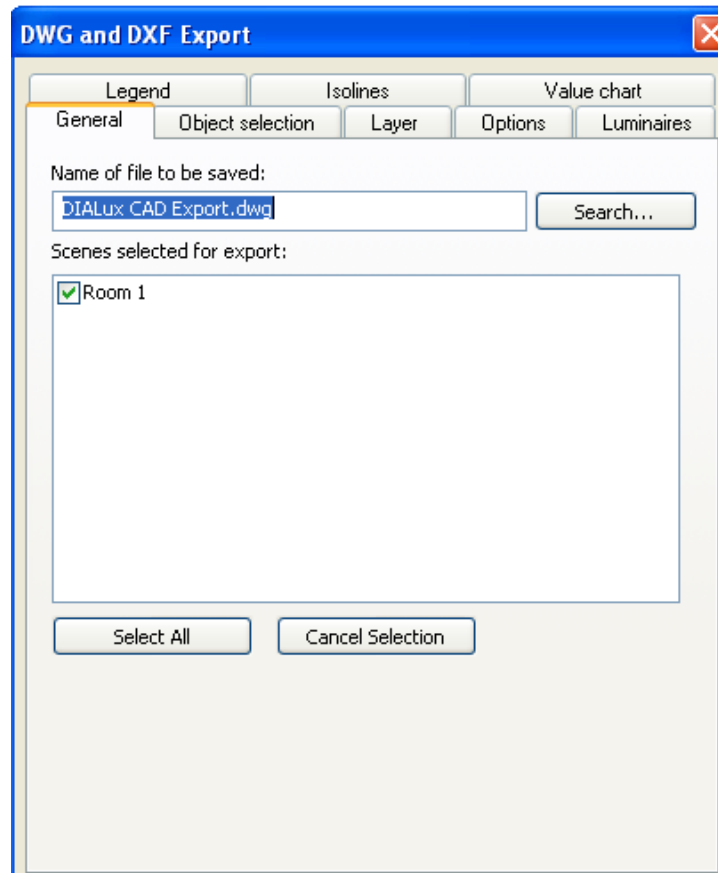

Fig. 465 General settings for the DWG/DXF export

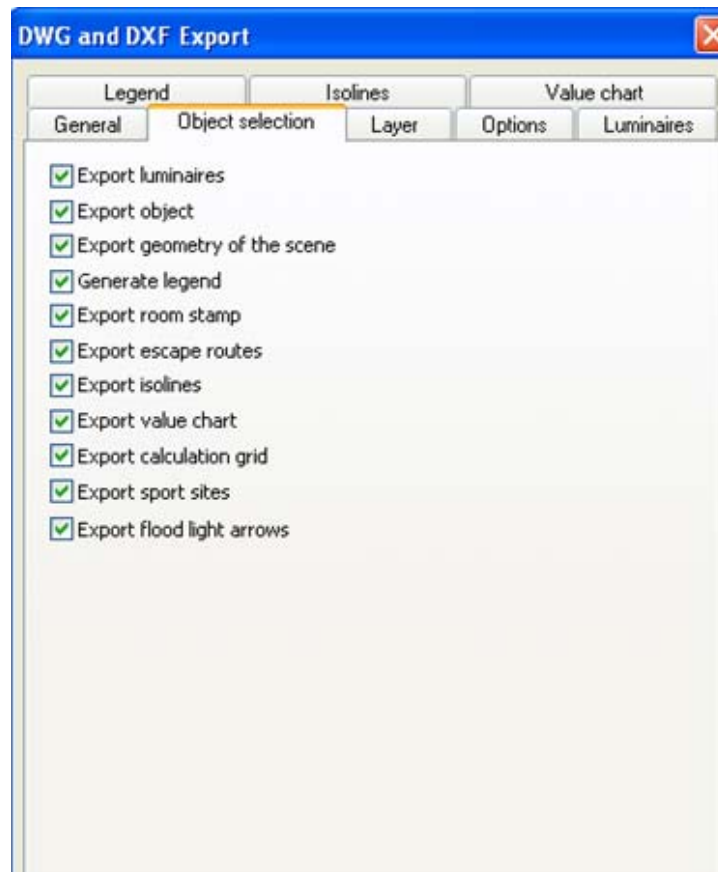

Fig. 466 Object selection

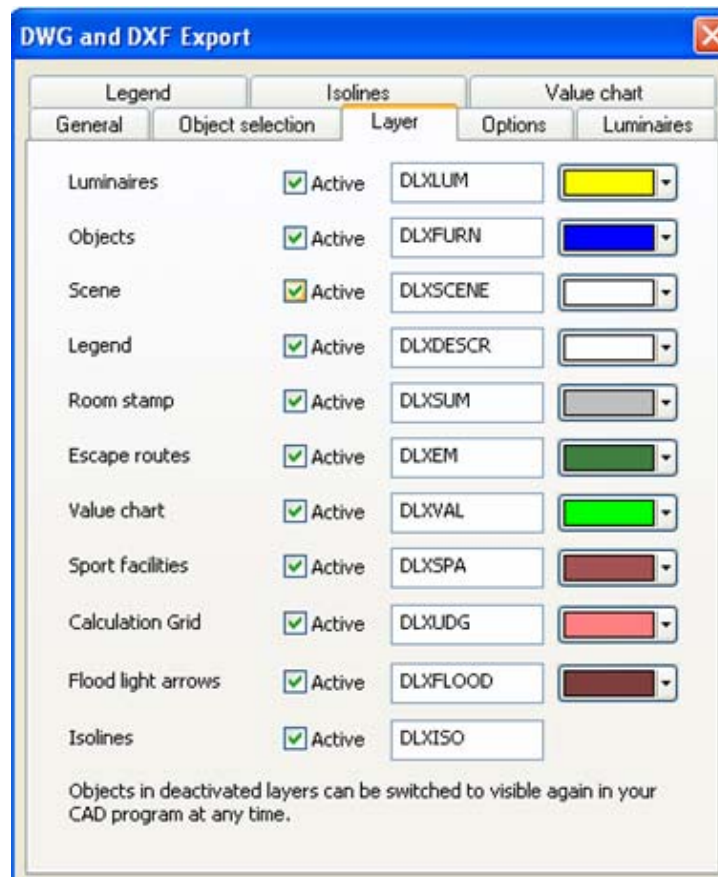

Fig. 467 Selection of the current layers and designations

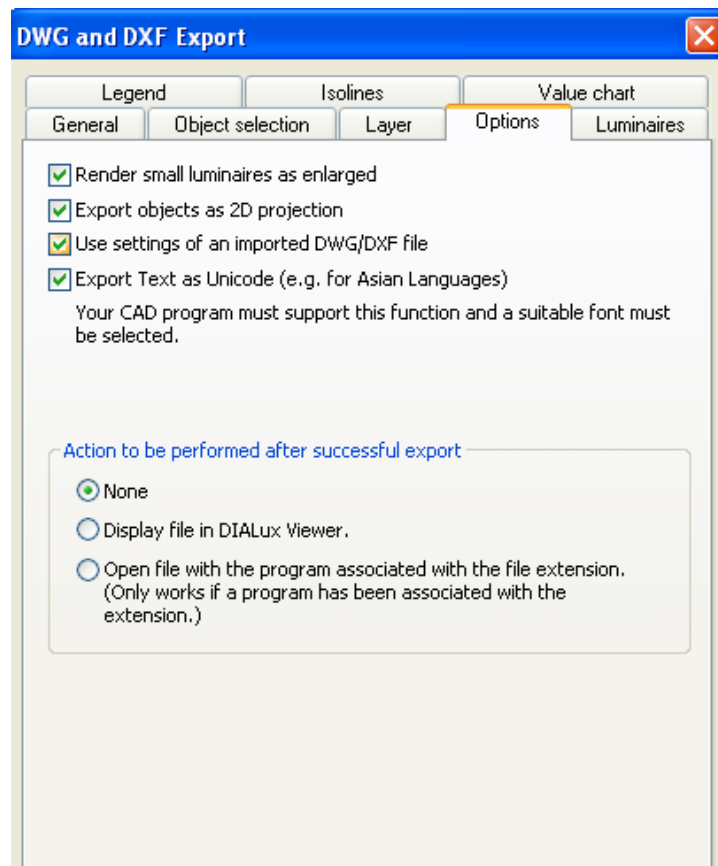

Fig. 468 Options for the export

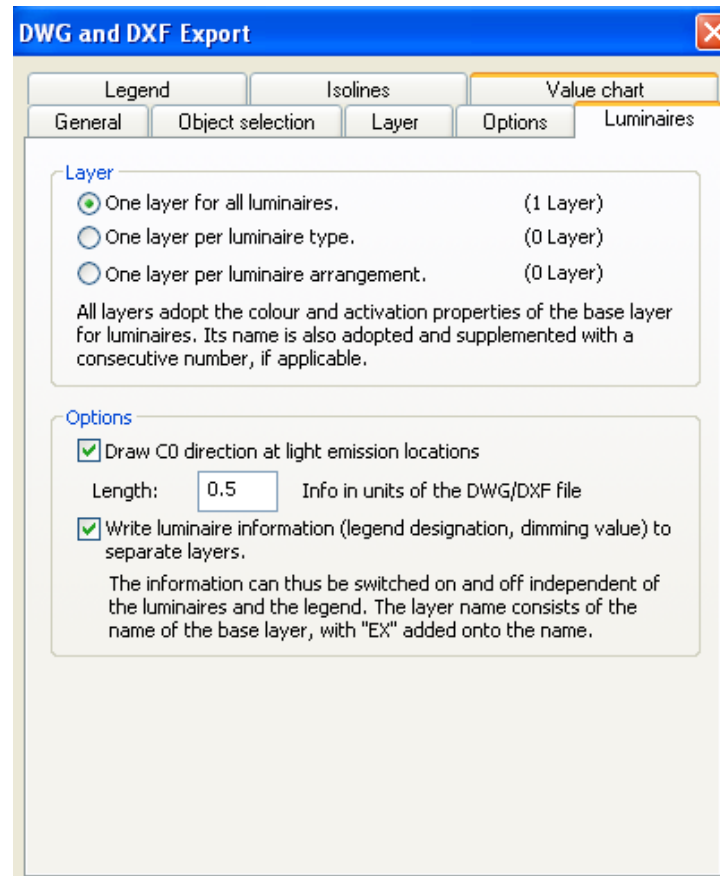

Fig. 469 Settings for the luminaire export

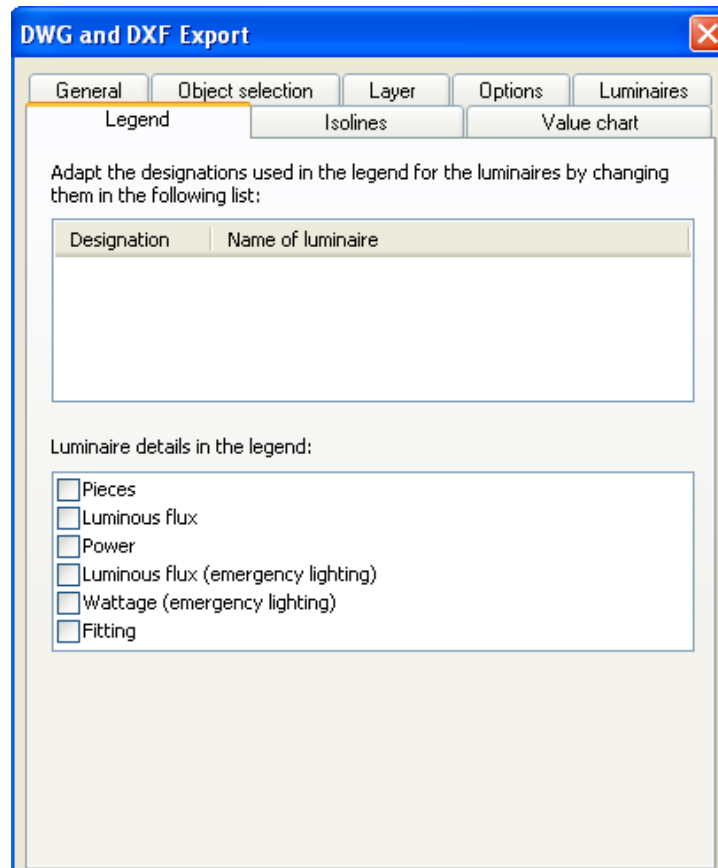

Fig. 470 Definition of the luminaires' legend

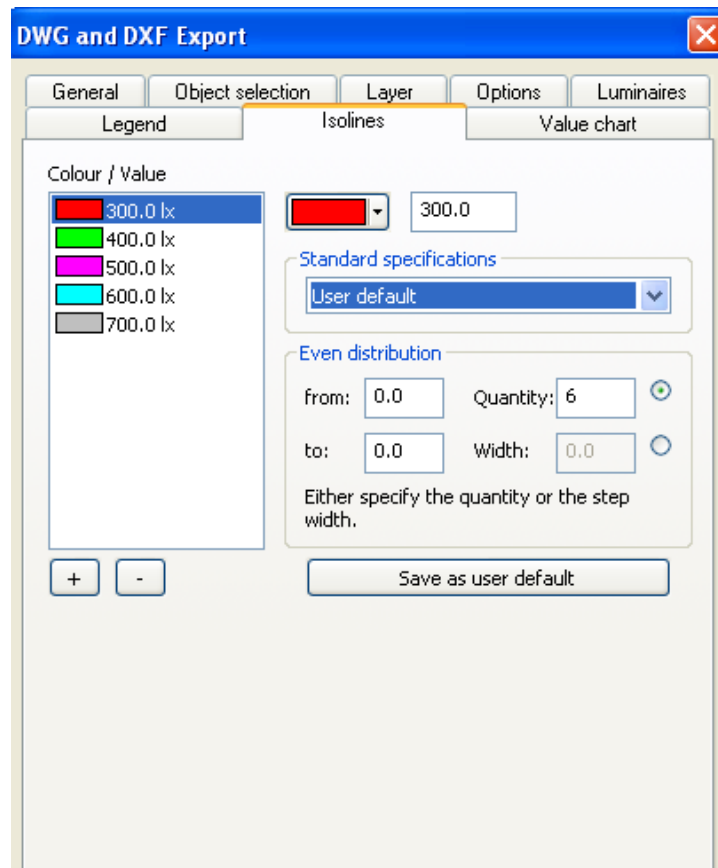

Fig. 471 DWG and DXF export - Isolines

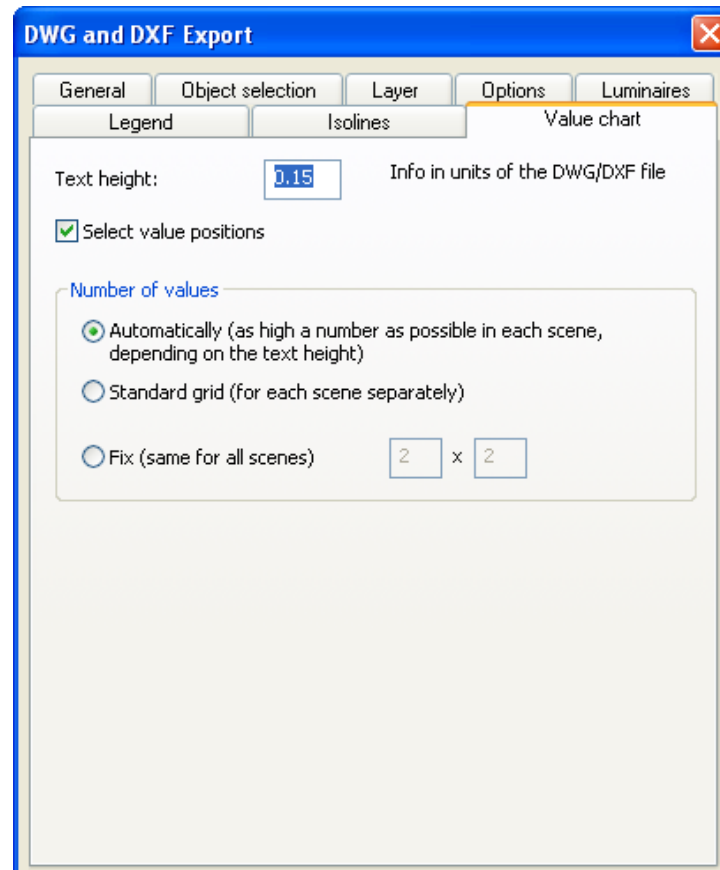

Fig. 472 Export of the value chart in dxf and dwg

You can specify the scope of the contents to be exported. The use of the settings of the original DWG or DXF file makes sense if you would like to integrate the DIALux planning there again.

gbXML file import

Up to Version 4.9 DIALux includes the *gbXML import*. This is the possibility to work with complex building projects. In the project you can modify and arrange lighting design for each room individually.

Importing gbXML

To import a *gbXML file* click "open project" at the welcome dialog, or menu → file → open, or → import gbXML file at the menu.

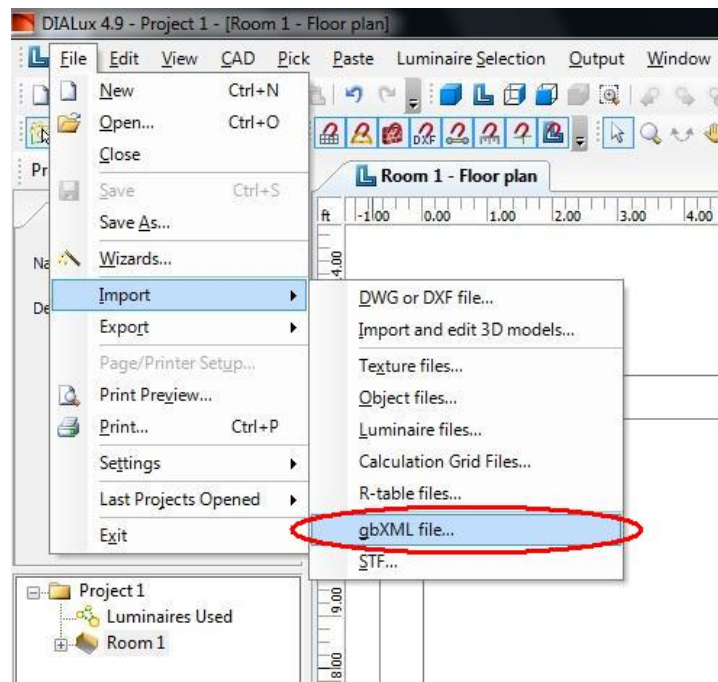

Fig. 473 Importing gbXML

Working with gbXML files

After importing the file from the project you can modify each room individually. The individual rooms are listed in the *project manager*.

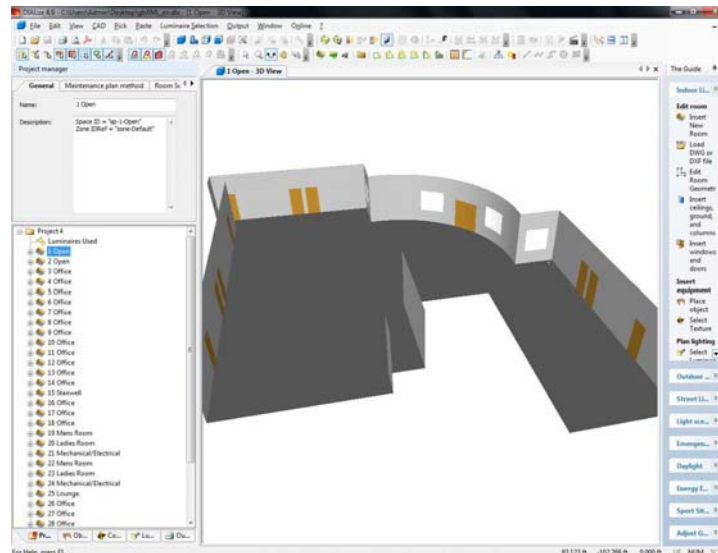

Fig. 474 Room overview in the project manager of agbXML file

To look at the individually listed rooms as a complete project, add the rooms, via right click onto "*edit daylight obstruction*" in the *project manager*.

STF Interface

The STF interface is supported by DIALux since version 1.0. The interface is continuously extended and improved. Via STF CAD programs can exchange their planning data with DIALux. The workflow is normally as follows:

Design in the CAD application by the architect / engineer.

Design of the building, the storey or the room(s). If necessary the luminaire positions can be defined in the CAD application as well, for example in the case of a redevelopment or if the luminaires have to be placed in certain positions.

Export of the information via STF file to DIALux.

Import of the STF file into DIALux. All the rooms defined in the CAD will appear in the DIALux project, including additional information like the position of doors, windows, degree of reflection, room information.... The user can now do the lighting design in DIALux. The correct fittings can be placed; additional calculation objects can be defined. The calculation will be done and the documentation of the design can be made in DIALux.

Export of the revised STF file from DIALux to the CAD application.

Depending on the CAD software used, a different level of information from the DIALux STF file is read in. The information exported by DIALux is for example the luminaire name, article number, description, electrical and light technical parameter, pictures, 3D model, isoline diagram and so on.

Further information about the STF interface can be obtained from dialog@dial.de or hotline@dialux.com

Energy Performance of Buildings

Background information

Under the Kyoto protocol, Europe is committed seriously to reduce CO₂ emissions. One instrument to achieve this is the directive 2002/91/EC "Energy Performance of Buildings Directive" of the European Parliament and Council. The directive's requirements hold for both new and to be renovated buildings and for both residential and non-residential buildings.

Member states of the EU were committed to implement this directive into national right. As a guideline the EU created a general framework for the calculation of energy performances of buildings, which stated which aspects the calculation methodology must at least include. These aspects are heating, ventilation, air-conditioning, hot water supply and lighting.

To support the implementation of the directive in the EU member states, the European committee for standardization CEN created a set of CEN standards. This set consists of more than 30 parts, includes more than 40 standards and drafts and covers 5 CEN technical committees. A good overview can be found in http://www.buildingsplatform.eu/epbd_publication/doc/P02_EPBD_CEN_Standards_p2370.pdf.

The part concerning lighting is EN 15193: "Energy performance of buildings – Energy requirements for lighting".

Besides the European implementation there are national implementations, for example in Germany the DIN 18599: "Energy efficiency of buildings". This standard uses an integral approach for the calculation of the

energy balance. That is a joint evaluation of energy demands for all parts of the building (heating, ventilation, air conditioning, cooling, humidification, domestic hot water and lighting), taking into account interactions between them and impacts on others. For example, the energy consumption for lighting is not only part of the energy balance for lighting, but also an inner heating source and so an important part of heating and cooling.

For more information about the directive please visit site www.buildingsplatform.eu. This site really covers everything about the directive that is worth knowing.

Why energy evaluation in DIALux?

In the medium term, the energy performance for buildings directive means more work for lighting designers. Besides the well known lighting data characteristics, they will also have to pay attention to new energy performance characteristics.

Fortunately, most lighting designs already contain a great deal of the necessary information for an energy evaluation. This information can be analyzed and reused for the energy evaluation. So if the energy evaluation is integrated into the lighting design process as efficiently as possible, the additional effort for this evaluation can be reduced significantly. That's why DIALux 4.9 offers the means to include an energy evaluation according to EN 15193 or DIN 18599.

A DIALux user can include an energy evaluation project into a DIALux project with only two mouse clicks.

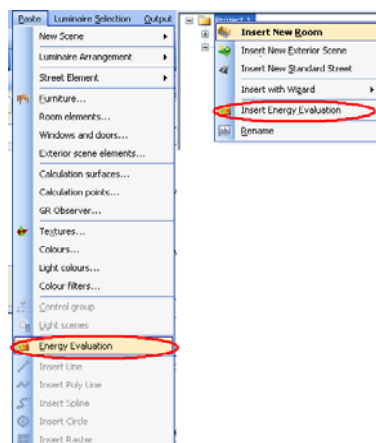

Fig. 475 Insertion of an energy evaluation project into a DIALux project via menu "Paste" and via the context menu of the DIALux project.

The rooms for lighting design can be transferred to the energy evaluation all together or only in part. It is important to realize that energy evaluation is only defined for inner rooms! Outdoor scenes and streets are not part of the evaluation.

Properties of the room and the project (geometry, obstruction, location and north alignment) are automatically identified, analyzed and reused for energy evaluation by DIALux. The same holds for windows and roof lights. In particular daylight and non-daylit assessment zones are determined automatically.

The specific connected load is no problem for the user too; it is taken directly from the planned luminaires in the room.

DIALux 4.9 is designed in such a manner, that a lighting designer is able to do a lighting design and fulfill energy requirements at the same time, with as little additional effort as possible. Ideally the additional energy evaluation needs only a few mouse clicks.

Structure of an energy evaluation project

Once an energy evaluation is part of a DIALux project, there is an energy evaluation project beneath the DIALux project.

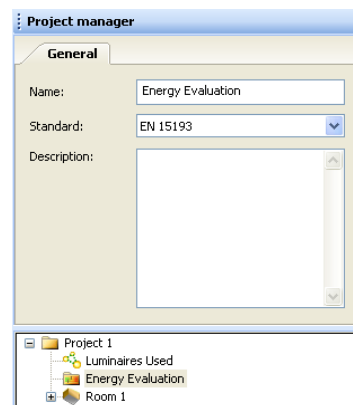

Fig. 476 Energy evaluation project in project tree

For this energy evaluation project a standard can be selected according to which the evaluation will be done. Currently EN 15193 and DIN 18599 are possible. Multiple simultaneous energy evaluation projects are not allowed.

An energy evaluation project is activated by adding energy evaluation rooms to it. This can be done either via the context menu of the energy evaluation project or via the context menu of a DIALux-room.

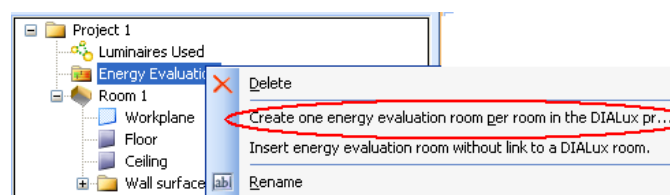

Fig. 477 Transfer of all DIALux-rooms into the energy evaluation project

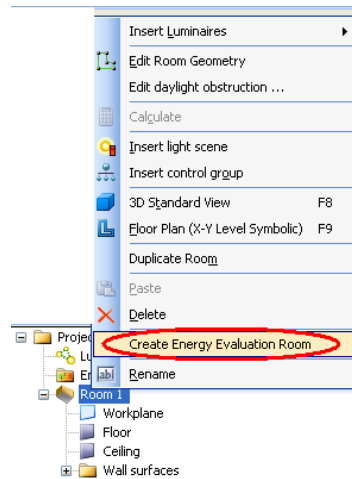

Fig. 478 Transfer of one single DIALux room into the energy evaluation project

With the first method all rooms of a DIALux project can rapidly be transferred to the energy evaluation project, so that they are part of the energy evaluation. Also you can create energy evaluation rooms without links to DIALux rooms in this context menu. Thus, you can evaluate energy demands for rooms, without doing any lighting planning for them, more about that later on.

The second method via the context menu of one or even multiple DIALux rooms is best if you do not want all rooms of a DIALux project to be part of the energy evaluation.

Caution: Each DIALux room can only be linked with one single energy evaluation room. Links with multiple energy evaluation rooms do not make sense, since each energy evaluation room can be taken into account multiple times during the energy evaluation.

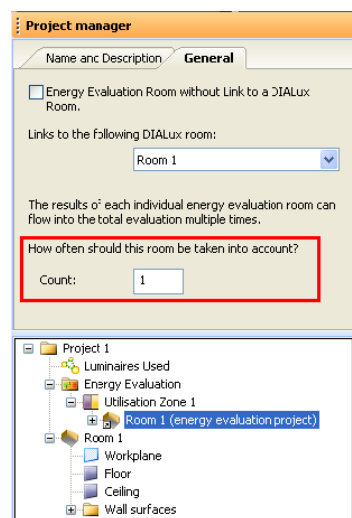

Fig. 479 Multi-consideration of one energy evaluation room during the evaluation of the complete energy performance project

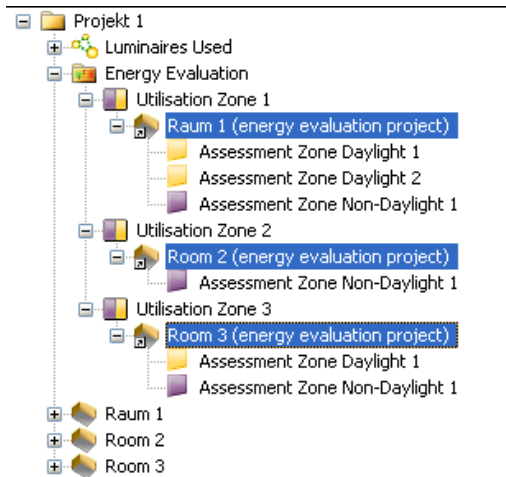

Fig. 480 Multiple energy evaluation rooms and there utilisation zones

Each energy evaluation room belongs to exactly one utilization zone. It is initially created in its own utilization zone, but can be moved to any other utilization zone.

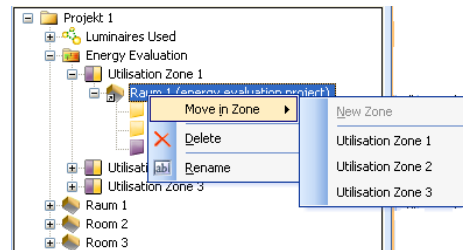

Fig. 481 An energy evaluation room with a selection of utilisation zones, to which it can be moved

Utilization zones are a main issue in DIN 18599, where they are used to collect energy evaluation rooms with the same utilization conditions to provide them with a common utilization profile.

Anyway utilization zones are a good way to group energy evaluation rooms.

Caution: Utilization zones can not be created explicitly; they are only generated during the creation of energy evaluation rooms.

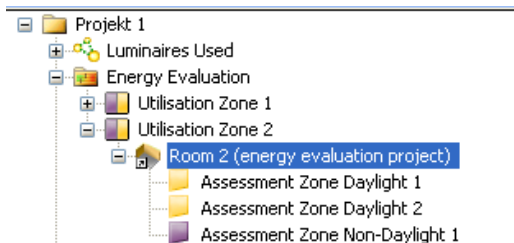

Fig. 482 Energy evaluation room in project tree with its assessment zones

Each energy evaluation room has one or more assessment zones. Each assessment zone is either completely supplied with daylight or not. Assessment zones can not be explicitly created, removed or changed in any way. They are exclusively created respectively

adjusted to geometric and daylight dependent conditions.

Each energy evaluation room is divided into assessment zones, that do not intersect one another and that build up the complete area of the room.

These assessment zones can be displayed in 2D- and 3D-views of the associated DIALux room. Daylight supplied and non-daylight supplied zones are distinguished by color.



Fig. 483 Display of assessment zones in CAD-windows (second icon from the left)

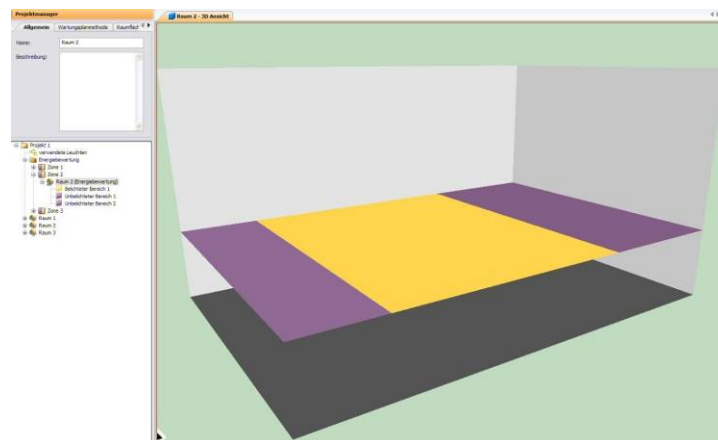

Fig. 484 Display of assessment zones of an energy evaluation room in 3D-view

Assessment zones are both the bottom and the most important level of the energy evaluation. The actual evaluation is done on this level, all needed parameters are determined here. Energy demands are explicitly calculated only for assessment zones, all other results for energy evaluation rooms, utilization zones or the complete energy performance project arise from summing up results of involved assessment zones.

Of course, you can also use “The Guide” to navigate through the complete energy evaluation process.



Fig. 485 Energy evaluations in The Guide

Energy evaluation rooms with and without links to DIALux rooms

As mentioned before, you can create energy evaluation rooms with a link to a DIALux room, but also without such a link.

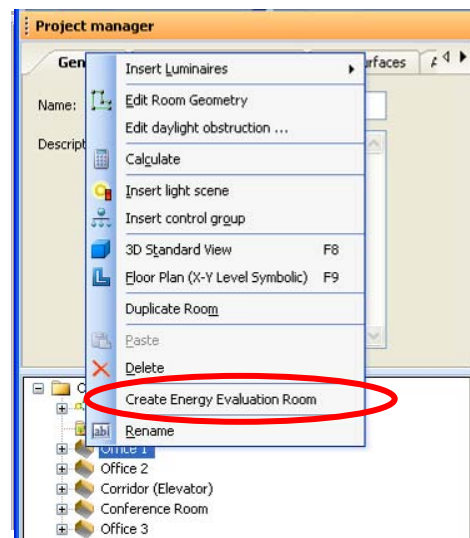

Fig. 486 Create an energy evaluation room with a link to a DIALux room.

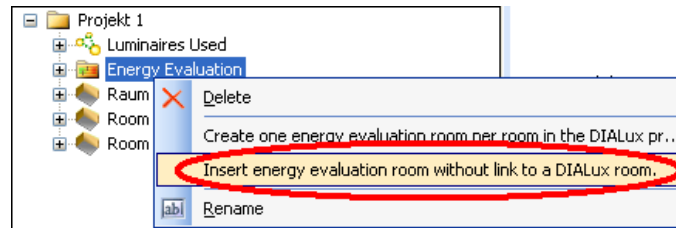

Fig. 487 Create an energy evaluation room without a link to a DIALux room

In the first case, an energy evaluation room is created that is linked to the corresponding DIALux room. In the second case, an energy evaluation room is created that is not linked to any DIALux room.

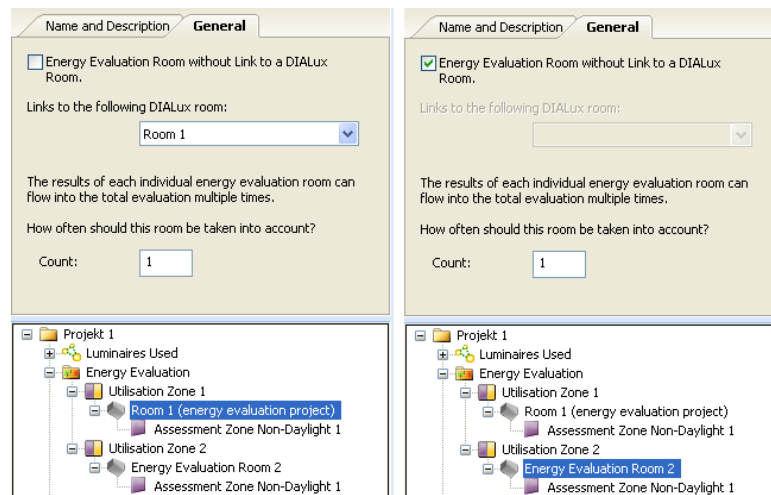

Fig. 488 Energy evaluation rooms with and without link to DIALux rooms

The linking of energy evaluation rooms and DIALux rooms has many advantages. Many aspects of the started or completed light planning can be automatically transferred to the energy evaluation with such links. The complete geometry of the DIALux room is analyzed for the energy evaluation, and this does not only mean the ground area and height, but even the daylight relevant information like position and properties of windows and roof lights, the orientation (north alignment) and obstruction, etc. One of the most important steps during energy evaluation, the determination of daylight supplied assessment zones, happens completely automatically. All technical information about luminaires and lamps are transferred as well. You do not need to think about mapping of total power values of luminaires and associated parasitic power values to assessment zones or even use some table or rough calculation methods to get such power values. All lighting data is determined from the light planning and assigned to the energy evaluation.

And the advantages are not limited to the creation of energy evaluation rooms and their assessment zones. A comprehensive update mechanism makes sure that

changes to all relevant data of the light planning will be passed on to the energy evaluation as well. So the energy evaluation is always up to date and simultaneous planning is possible.

Nevertheless, for a lot of details it makes sense, to have them well designed before a link is created. That's because DIALux tries to initialise all of the parameters of the energy evaluation room and its assessment zones as well as possible, so that the user has to do as little adjustments as possible. And the better the starting position the better the initialisations.

There is another important reason to do as much preliminary work as possible. As said before there is an update mechanism between light planning and energy evaluation, that reacts on subsequent changes. This update mechanism not only changes properties of assessment zones, it also may create new assessment zones and delete old ones. The new zones are once again initialised as well as possible by DIALux, but must again be checked and adjusted where applicable by the user. The old zones are deleted making the time spent checking and adjusting their properties is wasted.

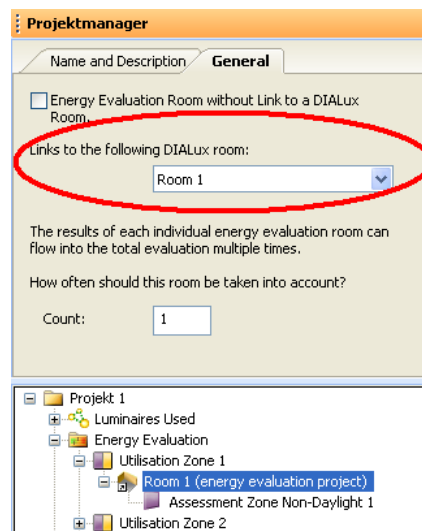

Fig. 489 Possibility to change the linked DIALux room for an energy evaluation room

Links between energy evaluation rooms and DIALux rooms can also be changed in the properties page.

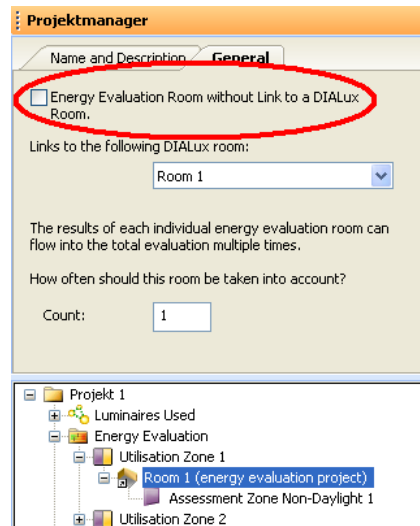

Fig. 490 Possibility to cancel the link of an energy evaluation room to a DIALux room

Caution: Each DIALux room can only be linked with one single energy evaluation room. As soon as there is a link between a DIALux room and an energy evaluation room, there can not be more. Therefore, there are only rooms in the selection list that are not linked to energy evaluation rooms.

And what makes an energy evaluation room without a link to a DIALux room different?

Because of lack of both geometric and lighting data information DIALux can't do any automatic subdivisions into assessment zones for such energy evaluation rooms, no statements concerning daylight are possible and there is no information about luminaires and lamps. All parameters for the energy evaluation have to be set manually by the user. In this process, the user is restricted to just editing the consumption values of the energy evaluation room directly or working on lots of parameters to calculate consumption values.

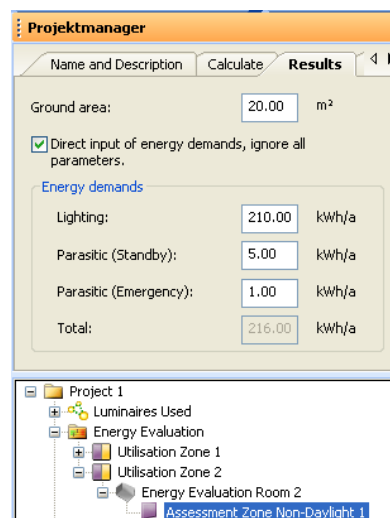

Fig. 491 Working on the assessment zone of an unlinked energy evaluation room

The possibilities of working with unlinked energy evaluation rooms in DIALux are relatively rudimentary right now. Each such room has exactly one assessment zone without daylight. More assessment zones can't be created, daylight provision can't be added. However, their main purpose is only to include rooms in the whole energy performance evaluation process, which have no light planning and whose energy consumption values are known from other sources.

In fact, you could do an energy performance evaluation in DIALux completely without linked rooms. But by doing so, you would abandon all advantages DIALux is offering for simultaneous light planning and energy evaluation. You would have to define and work on a lot of aspects that would be in place automatically for linked rooms. So our recommendation is to work with linked energy evaluation and DIALux rooms as far as possible.

Working on parameters

For each assessment zone you can adjust a lot of parameters, influencing the energy demands of that assessment zone. There are partly different parameters for the EN 15193 and the DIN 18599.

When using the DIN 18599, there are some parameters taken from the so called utilization profile of the super ordinate utilization zone. That can't be done in EN 15193, since there is no such profile.

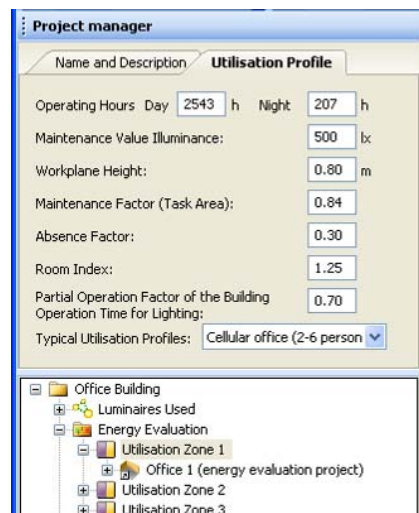

Fig. 492 Utilisation profile of an utilisation zone in a planning according to DIN 18599

Furthermore, there are some parameters only for daylight supplied assessment zones.

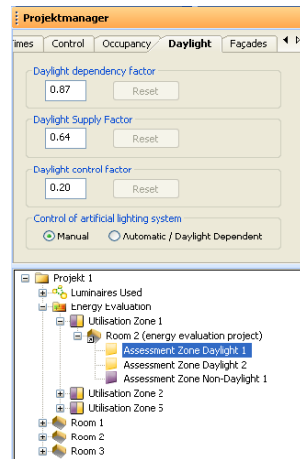

Fig. 493 One property page of a daylight supplied assessment zone
Some only for special daylight sources.

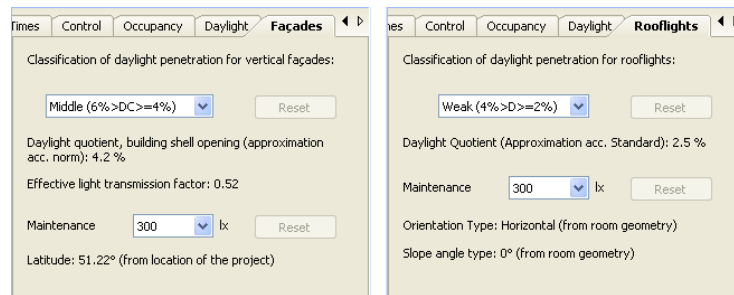

Fig. 494 Property pages for assessment zones, that are daylight supplied by windows respectively roof lights

Assessment zones of unlinked energy evaluation rooms have additional parameters, since direct input of energy consumption is possible.

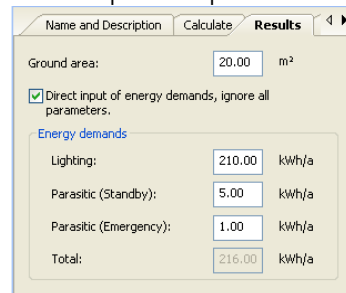

Fig. 495 Direct input of energy consumption values in unlinked energy evaluation rooms

Most parameters can be edited in the usual manner, others can only be read and some others can be edited normally and additionally are resettable to an internally calculated value.

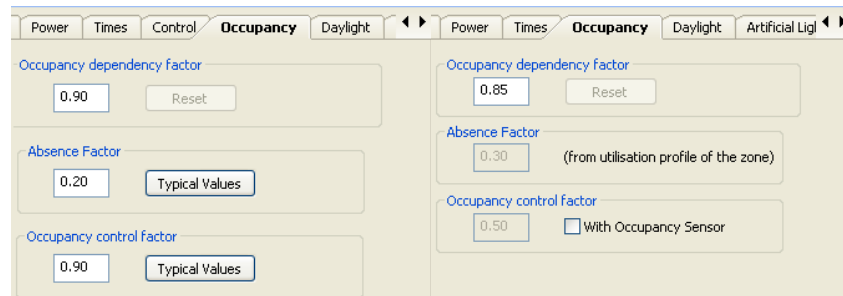

Fig. 496 Occupancy parameters of an assessment zone in EN 15193 (left) and in DIN 18599 (right)

Within an EN planning the parameters “Absence Factor” and “Occupancy Control Factor” can both be edited in the usual way. Both have even a supporting functionality to set them to typical values. The parameter “Occupancy Dependency Factor” results from these two parameters by expressions and formulas from the EN 15193. One can easily understand that by changing one of the first two parameters and watch the changes of the third one. There is only one calculated value of the third parameter that results from the other ones. Nevertheless, the third parameter can be edited in the usual way. There may be special circumstances or information that define this parameter differently. So when you edit such a parameter, this will be stated in the output. The documentation will include not only the edited value, used for the energy evaluation, but also the initially calculated value, resulting from the other parameters. In such cases, you are well advised, to state why you changed the calculated value in the description of the assessment zone. If you want to return to the calculated value, you can easily reset it by pressing the “Reset” button.

Within a DIN planning the “Absence Factor” is only readable, because it belongs to a utilization profile. The “Factor for Occupancy Control” is only readable as well, because it is only changed by the selection of “With Occupancy Sensor” yes or no. For the “Occupancy Dependency Factor” the same holds as with EN 15193.

There are a lot of relations and dependencies between parameters. They all have one thing in common: the compliance of the documentation, to explain and circumstantiate calculated energy demands.

Calculation and results

When the complete building is subdivided into utilization zones, all energy evaluation rooms are created, all assessment zones are determined and all parameters are adjusted, then it's time to calculate the energy demands and other energy characteristics. That's the moment when the real energy evaluation is done.

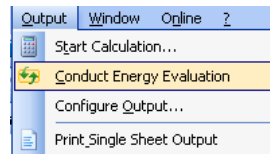

Fig. 497 Start of an energy evaluation in menu „Output“

You can start the energy evaluation either with “Conduct energy evaluation” in menu “Output” or with the icon of the same name.



Fig. 498 Start of an energy evaluation with the icon of the same name (second from left)

In both cases a complete energy evaluation for the whole energy evaluation project is done. There’s no selection of utilisation zones, energy evaluation rooms or assessment zones, as they are known from light planning calculations. That is why energy evaluation is very quick. It takes a lot less time than the user reading and editing a selection dialogue box.

As mentioned before, the real energy evaluation is done at the level of assessment zones. So when an evaluation is started, the energy demand for each assessment zone is calculated. Depending on the selected standard this may be “only” the total energy used for lighting or additionally the energy consumption used for illumination and the luminaire parasitic energy consumption. In each case annual consumption values are calculated. And that’s it, almost.

All other characteristics can be derived from these values. Monthly values can be obtained with the help of redistribution factors; values for energy evaluation rooms are nothing else than sums of values of their contained assessment zones, values for utilization zones nothing other than sums of values of their contained energy evaluation rooms, and so on. Even the Lighting Energy Numeric Indicator (LENI) from EN 15193 is nothing more than an area weighted value.

For assessment zones that are add to another assessment zone or to the super ordinate utilization zone, things are different. Such zones are not calculated independently.

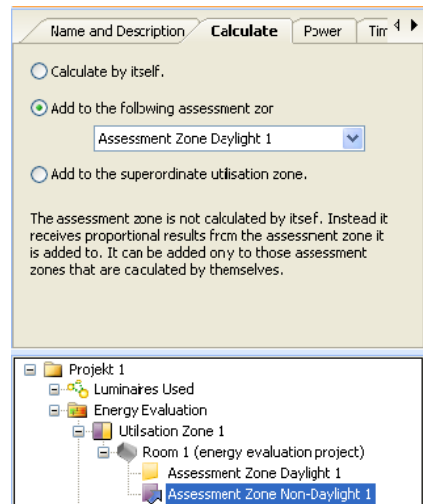

Fig. 499 An assessment zone that is added to another assessment zone

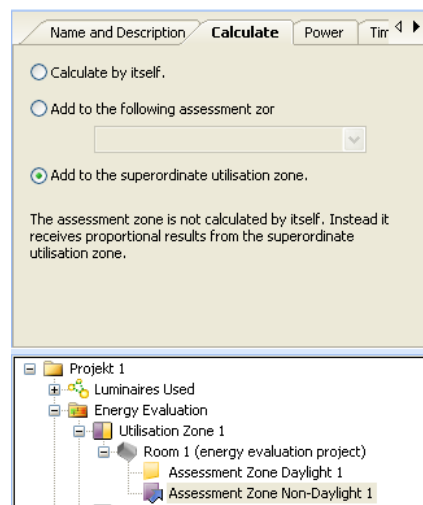

Fig. 500 An assessment zone that is added to the super ordinate utilisation zone

When an assessment zone is added to another zone or to the super ordinate utilization zone, then this zone is no longer calculated independently, that is on the basis of its parameters. Instead, the results of the other assessment zone respectively the results of the super ordinate utilization zone are allocated to the dependent assessment zone.

Such dependent assessment zones get their results as soon as the independent assessment zones are calculated. Results are simply allocated area weighted.

There are two main constraints concerning adding of assessment zones to others: First, you can only add to such assessment zones that are independently calculated. Second, each utilization zone needs at least one assessment zone that is independently calculated.

Documentation of energy evaluation results

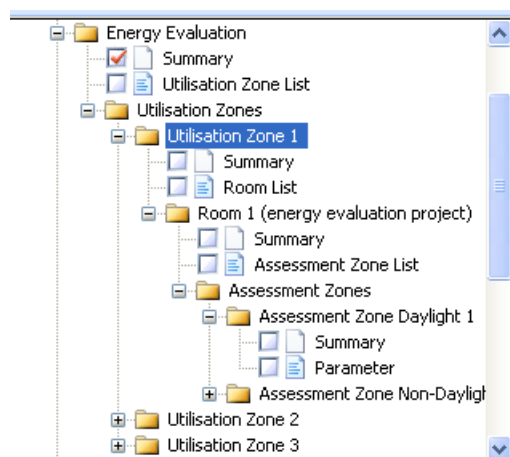

Fig. 501 Outputs for an energy evaluation

There are several outputs for an energy evaluation, to show the calculated energy demands for different objects.

The calculated total energy demands for lighting and other energetic characteristics can be shown for the complete energy evaluation project, for each contained utilization zone, each energy evaluation room and for each assessment zone. A subdivision in monthly values is also possible for each object.

Energy Evaluation / Summary							
Energy Evaluation According to Following Standard: EN 15193							
Location: London, Eng, Longitude: -0.10°, Latitude: 51.50°							
Results							
Total Energy Lighting: 10068.05 kWh/a							
LENI: 40.98 kWh/(a · m²)							
Total Energy Visual Task: 10068.05 kWh/a							
Total Energy Parasitic (Total): 0.00 kWh/a							
Total Energy Parasitic (Standby): 0.00 kWh/a							
Total Energy Parasitic (Loading the Emergency Lighting): 0.00 kWh/a							
Total Area: 245.71 m²							
Monthly Results							
Month	[kWh]	Lighting [kWh/m²]		Visual Task [kWh/m²]	[kWh]	Parasitic [kWh/m²]	
Jan	921.99	3.75	3.75	921.99	3.75	0.00	0.00
Feb	870.20	3.54	3.54	870.20	3.54	0.00	0.00
Mar	829.28	3.38	3.38	829.28	3.38	0.00	0.00
Apr	790.11	3.22	3.22	790.11	3.22	0.00	0.00
May	769.78	3.13	3.13	769.78	3.13	0.00	0.00
Jun	772.42	3.14	3.14	772.42	3.14	0.00	0.00
Jul	776.00	3.16	3.16	776.00	3.16	0.00	0.00
Aug	782.75	3.19	3.19	782.75	3.19	0.00	0.00
Sep	811.76	3.30	3.30	811.76	3.30	0.00	0.00
Oct	854.44	3.48	3.48	854.44	3.48	0.00	0.00
Nov	944.22	3.84	3.84	944.22	3.84	0.00	0.00
Dec	944.22	3.84	3.84	944.22	3.84	0.00	0.00
List of the Participating Utilisation Zones:							
• Utilisation Zone 1							
• Utilisation Zone 2							
• Utilisation Zone 3							
• Utilisation Zone 4							
• Utilisation Zone 5							

Fig. 502 Output for the complete energy evaluation project with all important characteristics

Of course, the user has the possibility to select which details are shown on each output page.

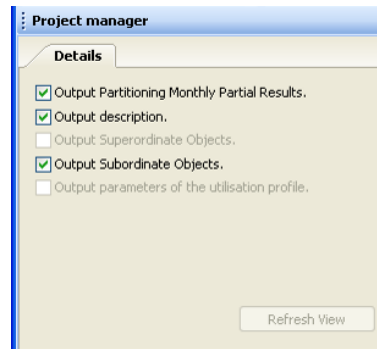



Fig. 503 Property page of the above output page

The output of all involved parameters is most important, because all energy performance standards demand such documentations.

Assessment Zone Daylight 1 / Parameter

Energy Evaluation According to Following Standard: EN 15193

Accompanying Project: Energy Evaluation
 Accompanying Utilisation Zone: Utilisation Zone 1
 Accompanying Energy Evaluation Room: Office 1 (energy evaluation project)



Parameter	Value
Total installed lighting power [W]	914
Parasitic power of controls with lamps off [W]	0
Emergency lighting charging power [W]	0
Daylight Time Usage [h]	2250
Non-Daylight Time Usage [h]	250
Emergency lighting charge time [h]	8760
Constant illuminance factor	1.00
Constant Illuminance Controllable	/
Maintenance factor	0.67
Occupancy dependency factor	0.90
Absence Factor	0.20
Occupancy control factor	0.90
Daylight Source	Rooflight
Daylight dependency factor	0.83
Daylight control factor	0.20
Control of artificial lighting system	Manual
Daylight Supply Factor	0.85
Maintenance Value of the Illuminance [lx]	300
Classification of daylight penetration	Weak (4%>D>=2%)
Mean Daylight Factor for Rooflights	3.7
Orientation	Horizontal
Slope angle [°]	0

Fig. 504 Parameter output for an assessment zone

Attention should be paid to using descriptions for assessment zones and other energy evaluation objects. These descriptions should not be too long, but should frequently be used. With precise comments you can explain the selection of one or more parameters. Particularly with regard to manually adjustments to automatically calculated values such explanations are in fact mandatory.

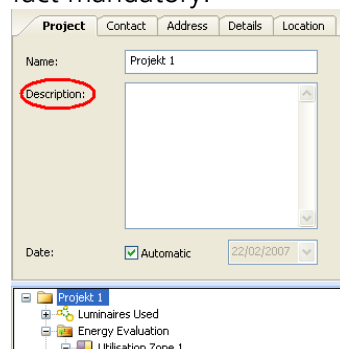

Fig. 505 Input of a description for an assessment zone

Making videos in DIALux

To create a video with DIALux you have to define the camera path. First open the lighting design in the 3D window then use the command "File -> Export -> Save 3D video...". Now a camera path appears in the CAD window.

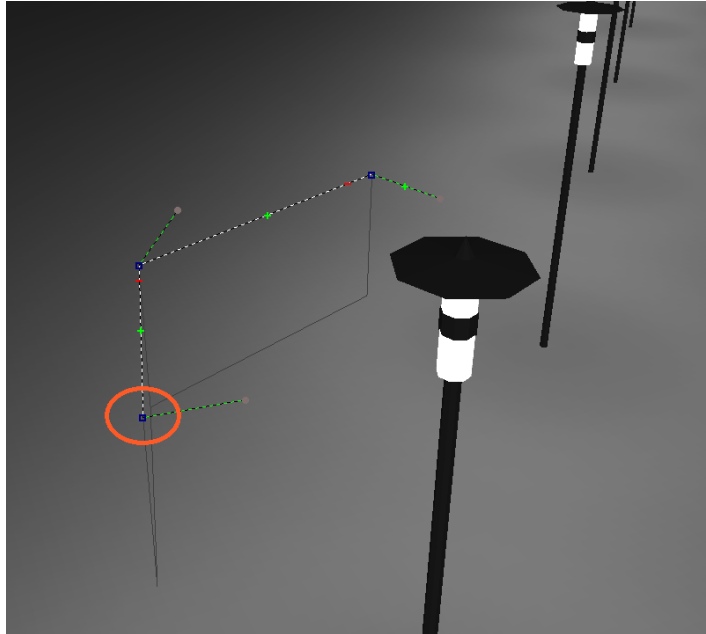

Fig. 506 Inserting a camera path in the 3D view

At the beginning, the end and at all inserted points of the path, the camera position in X and Y direction can be defined by left click and moving the mouse. The Z position can be changed by left click and holding down the control (CTRL) key.

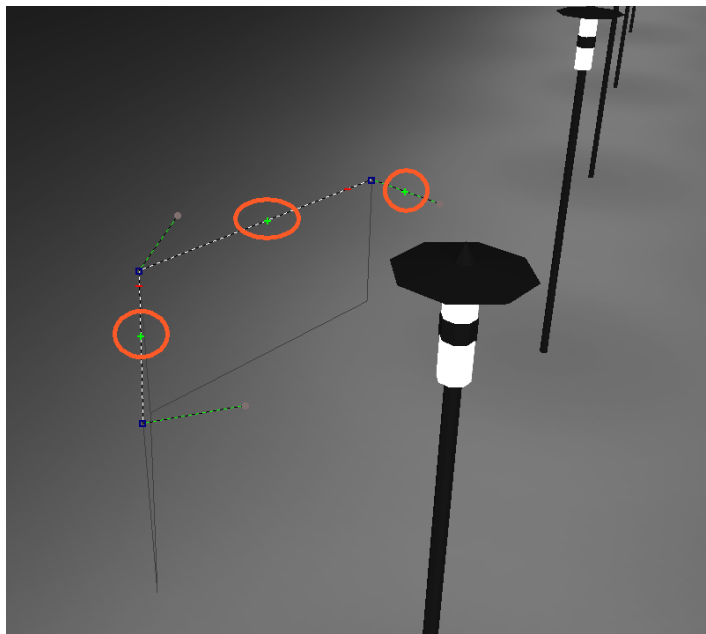

Fig. 507 Inserting additional camera positions along the path

Near to the end points and in the middle between two points there are green "+" symbols. By clicking on these symbols, a new point is inserted into the camera path. If the red "-" symbol is clicked, the associated point is deleted.

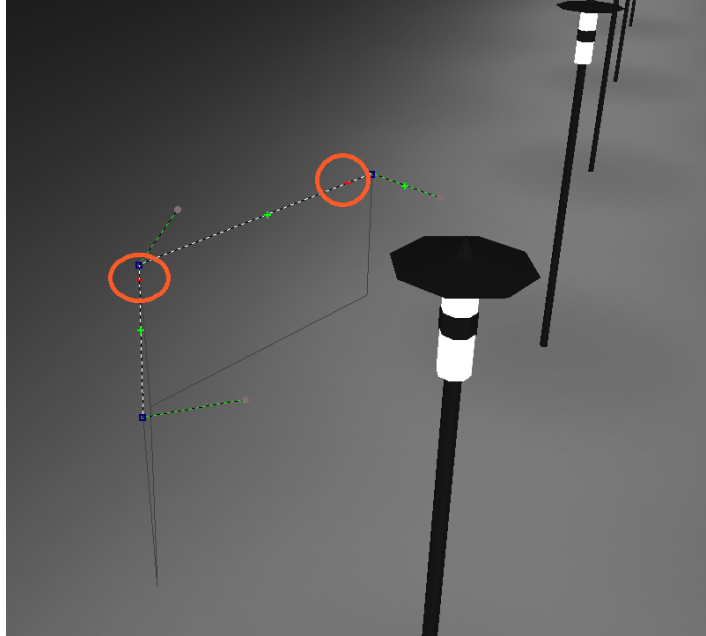

Fig. 508 Deleting camera positions

At all the points there are thin green lines drawn. These lines are defining the "viewing direction" of the camera. The small ball at the end of these lines can be moved with the mouse. To move into the Z direction hold down the control key.

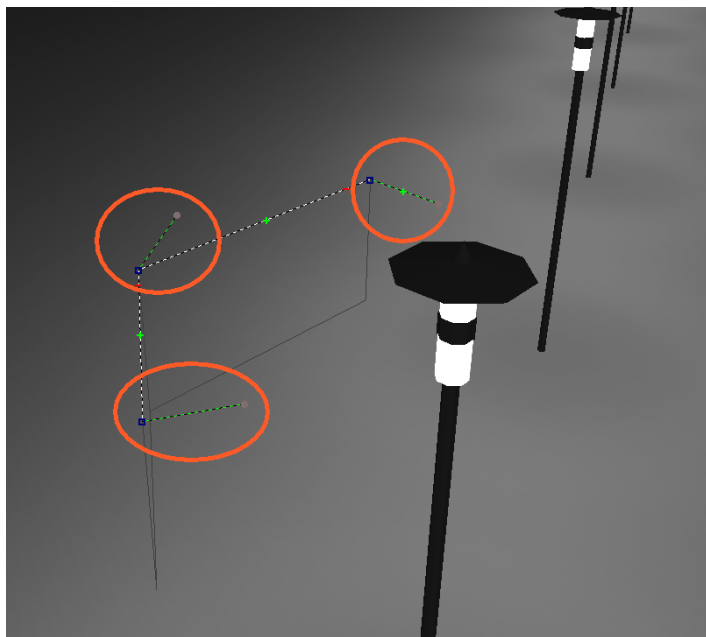

Fig. 509 Defining the camera viewing direction

The camera is moving along the path from point one to point two. It is turned during the movement according to the viewing directions in point one and two. If you want to have more rotations on the way from point one to point two, you have to insert more points directly on the path only changing the viewing direction and not the position of the path.

The camera is not following strictly the path. The path is converged to the edges. That makes the video smoother and there is no judder effect.

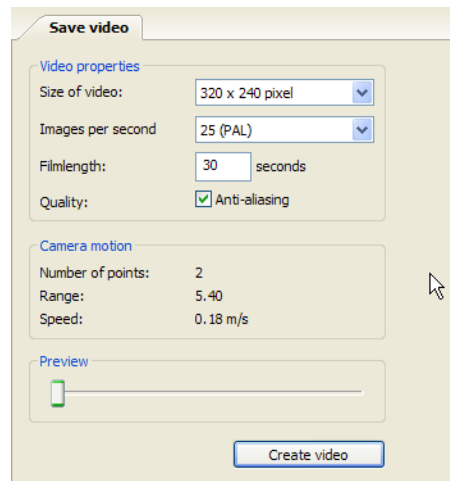

Fig. 510 Settings of the video

Besides the camera path and the camera viewing direction, also the video size the number of frames per second and the duration can be defined. The size defines the number of pixels in the X and Y direction on the screen. The higher the resolution, the more space is required to save the video. If you want to prepare a presentation for a TV (DVD or S-VCD) you should select a standard resolution. In Europe the PAL format is common; in the US the NTSC format is used normally. Also the frame rate is defined in the standard format. The camera speed is defined by the film length, the frame rate and the length of the camera path. The speed along the camera path is constant. If anti-aliasing is selected, the quality of the video will be better but this function needs also some calculation time. In the field "camera motion" you can see a summary of the camera path and speed.

Moving the slider "Preview" brings the 3D CAD view into the position of the camera along the path. So you can check the resulting video before you have created it. If the DIALux project becomes bigger a good graphic card is absolutely necessary. We recommend a Nvidia graphic card with a memory of at least 128MB. If you are working in MESA mode and the DIALux project is

complex (a lot of objects, a large area ...) the 3D CAD will soon start to judder.

Clicking on "Create video" will open a Save As dialog. The location and the filename have to be selected here. After that a standard windows dialog appears where the user can select the video codec to compress the movie.

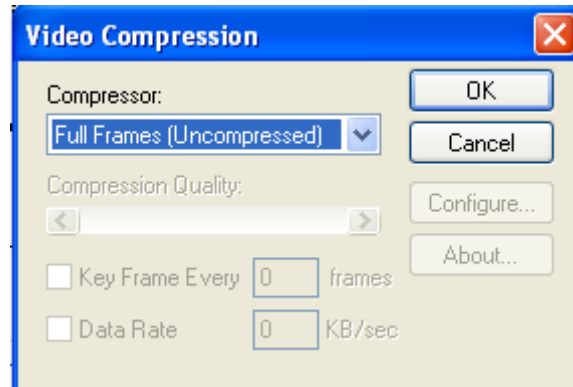

Fig. 511 Windows dialog for the video compression settings

In the drop down list all the codecs installed on the computer will be listed. These codecs are not installed by DIALux. The quality of the codec is responsible for the quality of the video. The better a codec is, the smaller the size of the file will be and the higher the quality of the video will be. Some of the codecs are free of charge. The codec has to be installed on the computer that creates the movie and on the computer that plays the movie. Microsoft XP already includes several codecs. These are available on all the XP machines if they were not deselected during the installation of the operating system. Some codecs are available from the internet. For example from here: www.divx.com or here: <http://www.divx-digest.com/software/xvid.html>. The last link leads to an open source project. The official site is here: <http://www.xvid.org>. Some of the codecs are offering a wide range of settings. Please click on settings to define the settings for the creation of the video. DIAL can not offer any support for the usage of a codec. NOTE a wrong codec or the selection of "uncompressed" full pictures will create a very large file size for the video. Start to test your codecs with small videos to find out which one and which settings are the best.

Important:
You can open the separate
POV-Ray help with "F1"
while POV-Ray is running.

Raytracer

For raytracing DIALux uses the external programme *POV-Ray*. If you want to have more detailed information about POV-Ray and the possible settings you can use the "F1"-key to open the POV-Ray help.

Background

DIALux automatically copies POV-Ray onto the PC. The software will be installed when the user for the first time starts to calculate a photorealistic image. The setup installs the standard version of POV-Ray 3.6. This software is freeware and available at www.povray.org. Additionally DIALux installs an adapted version of the *povengine.exe* into the DIALux directory. The major difference between the DIALux version and the original version of POV-Ray is that the DIALux version can handle real photometry of luminaires. The measured light distribution of a luminaire is used to define the distribution of light. The original version can only handle ideal light sources like spot and ambient light. Whenever the DIALux user wants to edit the POV-Ray files, it is important to use the *pvengine.exe* in the DIALux directory e.g.

"C:\Program Files\DIALux\pvengine.exe". Otherwise the *.pov file can not be interpreted. You can continue to work with POV-Ray to edit the scene generated with DIALux. All functions of POV-Ray are available. For further editing you must use the program "pvengine.exe" that is stored in the directory "C:\Programs Files\DIALux\". You cannot use the original POV-Ray software.

POV-Ray Settings within DIALux

The most important settings for the raytracing with POV-Ray can be made in DIALux. For the standard use of the photorealistic visualisation these settings are adequate. Expert users can use all the features of POV-Ray by loading the *.pov file made with DIALux into the editor of POV-Ray.

Photo Realistic Images with Raytracing

Raytracing means that the light beams from your own point of view with respect to mirroring, transparency and roughness of surfaces are followed.

Basic Settings

The newest version of the Raytracer POV-Ray (3.6) is integrated in DIALux. This is substantially quicker and can choose the right brightness settings independently. For the visualizations with POV-Ray the spectral distributions of the lamps and the colour filter as well as the dimming level for the control groups are handed over

automatically. In the menu file *Export* you find the option *Raytracing with POV-Ray* which opens a dialogue where the usually recommended settings are selected. In the quick preference tab you can define the basic settings for your first applications. Experienced users might change options for *Indirect Calculation*, *Brightness Preferences* and *Image Preferences*.

Quick preferences

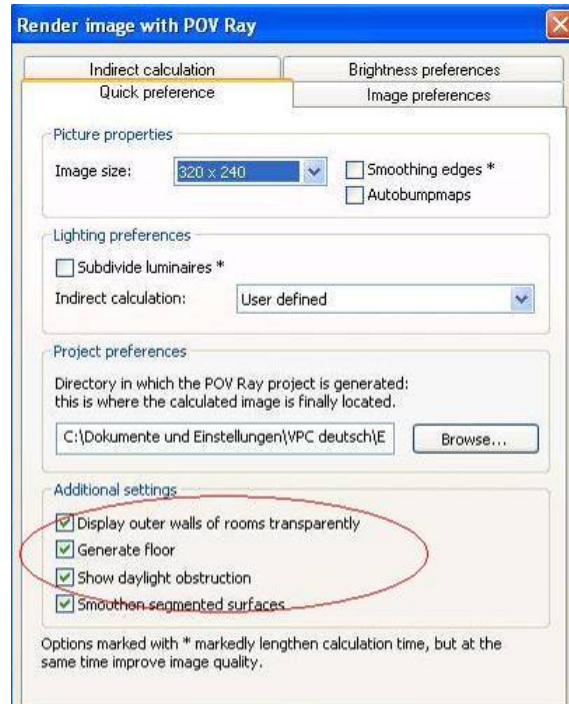

Fig. 512 Basic settings for Raytracing

In the *quick preferences* tab there are the following settings:

- *Picture properties:*
Here you can define the size of the generated picture in pixels (length × height). The larger the number of pixels, the larger is the final result. In addition, a large picture extends the calculation time.
- *Smoothing edges (Anti-aliasing):*
This feature improves the transitions at edges, e.g. from walls. This should be activated if textures with lines are used, like tiles, bricks or pavement. This setting uses a lot of calculation power so it should not be used for preview pictures. Not only textures are smoothed, also the edges of the geometry will be straightened. A higher degree of Anti-aliasing can be selected in the POV-Ray editor. See advanced settings.

Additional settings are possible in the *Quick preference* tab

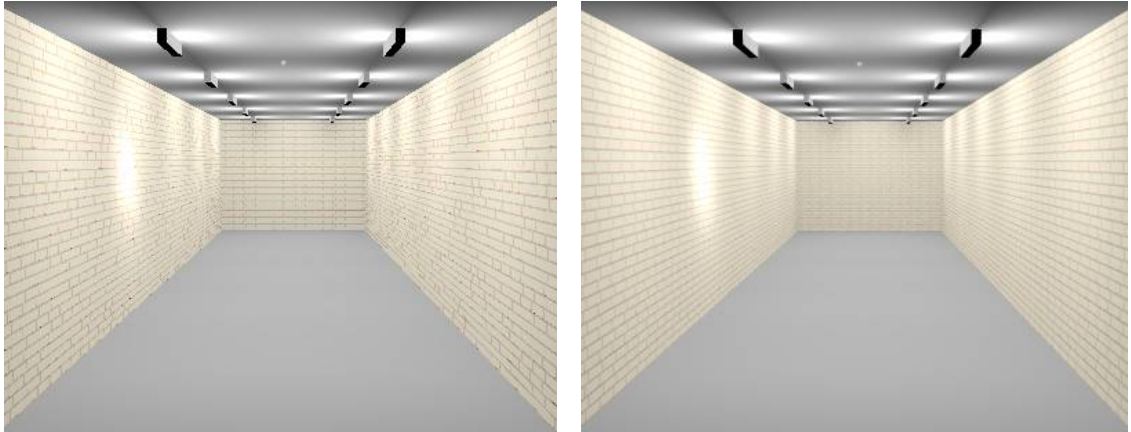

Fig. 513 Smoothing edges with POV-Ray

- *Autobumpmaps:*
 If textures are used which have a surface texture, e.g. wood or tiles, you can produce a better 3D view with the activation *Autobumpmaps*. They should be activated, if the light-dark information of the texture is identically with the high-low structure. E.g. water, bricks, wood. The bump map texture will be calculated from the grey values of the image. Within POV-Ray also there are independent bump maps that can be placed.
- *Lighting preferences:*
 With *Subdivide luminaires* you can specify whether the influence of each individual luminaire or all luminaires should be calculated together. The *Subdivide luminaires* setting generates a better result, however the calculation time extends. Without this option, the light rays are starting only in the middle of the light emitting surface. If a long luminaire is placed near to surface, the resulting image seems unrealistic. If this option is switched on, for each pixel, depending on the distance to the light source, the luminaire is subdivided into small luminous parts. Of course, this increases the calculation time.
 With *Indirect calculation* you can specify the influence of the indirect lighting on the result. The higher you select the part that indirect lighting plays, the longer the calculation time becomes. This option starts an elementary radiosity. Without this option, those objects which are not directly hit by rays are invisible. The higher the accuracy that is chosen, the longer the calculation takes but the quality increases. For exterior scenes sometimes it could be better to skip the indirect calculation. For a first preview, the indirect calculation should be switched off or "standard" should be selected. If directional lighting (mainly spots) is used, high to very high indirect calculation should be selected. For

diffuse, uniform illumination standard settings are adequate. This setting defines the number of rays used, for the calculation of the indirect light on each pixel. The more rays there are, the more correct the results are.

- *Project preferences:*
After POV-Ray completed its work, by default the rendered image (bitmap *.bmp) is stored in the directory - as standard preference in:
"C:\Program Files\DIALux\Raytracer\Room 1\...bmp".
- Additional preferences are possible. You can display outer walls of rooms transparently or daylight obstruction by using the checkboxes.

Image preferences

This defines the size of the picture in pixel. Any size can be selected. The aspect ratio is 4:3. This ratio is correct for projectors, most monitors and TV screens. Modern TVs and laptops can have ratios of 16:9 or 16:10. To define such a ratio see advanced settings. For a first picture you should always start with a small picture like 640 x 480.

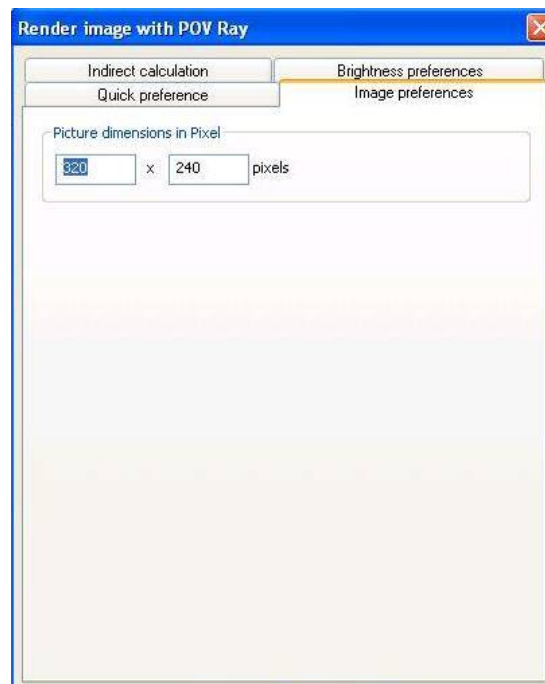

Fig. 514 POV Ray – Image preferences

Indirect calculation

In addition to the settings of "indirect calculation" of the quick preferences, in this dialog the indirect calculation can be defined in a more detailed way.

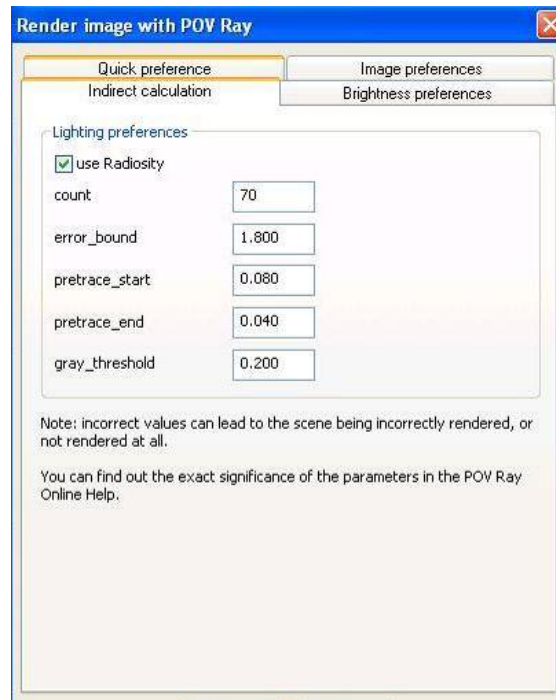

Fig. 515 POV Ray – Indirect calculation

The checkbox *Use Radiosity* switches the indirect calculation on and off.

- *Count*
The integer number of rays that are sent out whenever a new radiosity value has to be calculated is given by count. A value of 35 is the default, the maximum is 1600. When this value is too low, the light level will tend to look a little bit blotchy, as if the surfaces you're looking at were slightly warped. If this is not important to your scene (as in the case that you have a bump map or if you have a strong texture) then by all means use a lower number.
- *Error bound*
The error bound float value is one of the two main speed/quality tuning values (the other is of course the number of rays shot). In an ideal world, this would be the only value needed. It is intended to mean the fraction of errors tolerated. For example, if it were set to 1 the algorithm would not calculate a new value until the error on the last one was estimated at as high as 100%. Ignoring the error introduced by rotation for the moment, on flat surfaces this is equal to the fraction of the reuse distance, which in turn is the distance to the closest item hit. If you have an old sample on the floor 10 inches from a wall, an error bound of 0.5 will get you a new sample at a distance of about 5 inches from the wall. The default value of 1.8 is good for a smooth general lighting effect. Using lower values is more

accurate, but requires a higher count. You can use values even lower than 0.1 but both render time and memory use can become extremely high then.

- *Pretrace*
To control the radiosity pre-trace gathering step, use the keywords `pretrace_start` and `pretrace_end`. Each of these is followed by a decimal value between 0.0 and 1.0 which specifies the size of the blocks in the mosaic preview as a percentage of the image size. The defaults are 0.08 for `pretrace_start` and 0.04 for `pretrace_end`.
- *Gray threshold*
Diffusely interreflected light is a function of the objects around the point in question. Since this is recursively defined to millions of levels of recursion, in any real life scene, every point is illuminated at least in part by every other part of the scene. Since we can't afford to compute this, if we only do one bounce, the calculated ambient light is very strongly affected by the colours of the objects near it. This is known as colour bleed and it really happens but not as much as this calculation method would have you believe. The `gray_threshold` float value grays it down a little, to make your scene more believable. A value of 6 means: calculate the ambient value as 60% of the equivalent gray value calculated, plus 40% of the actual value calculated. At 0%, this feature does nothing. At 100%, you always get white/gray ambient light, with no hue. The following pictures show a spot light (white) directed to a green wall. The first picture has a gray threshold value of 0, the second of 0.5 and the last a value of 1.

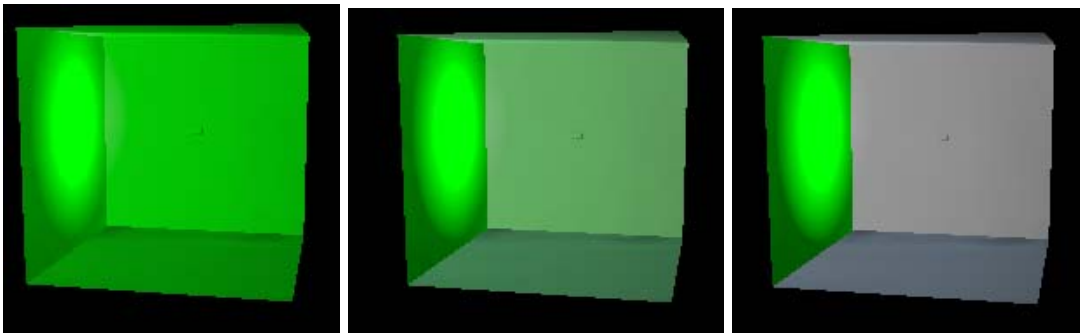

Fig. 516 Indirect calculation

Brightness preferences

In the *Brightness preferences* tab you can define, whether the scene tends to be rather dark or bright. Rule of thumb: the more luminaires that exist in the project,

the brighter they becomes as does the scene. It would help to test it. In addition to the quick settings, the brightness of the picture can be manipulated freely. If there are too dark areas in an image, decrease the low_value slightly downwards. This will make more details visible were it has been too dark. If parts of the image seems to be overexposed (the ceiling in a room with only indirect light), modify this value upwards, to make more details visible.

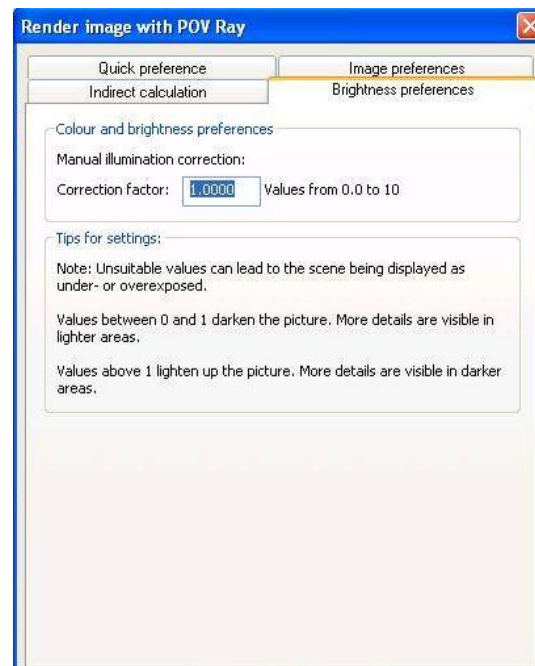

Fig. 517 POV Ray – Brightness preferences

Now the new version of the Raytracers (POV-Ray 3.6) allows the conversion of the light colours from the control groups, so that the rendered image is shown in colour.

Raytracing-Options for Surfaces

You can assign certain options to all surfaces of the room, the room elements or the furniture. Just select the surfaces and use the Property Page to adjust the values. You may select several surfaces using the *Shift*-key or the *Ctrl*-key. The option *Autobumpmaps* assigns an additional structure like for example some ripple to the texture.

Glass surfaces should have 15% reflection and 30% transparency

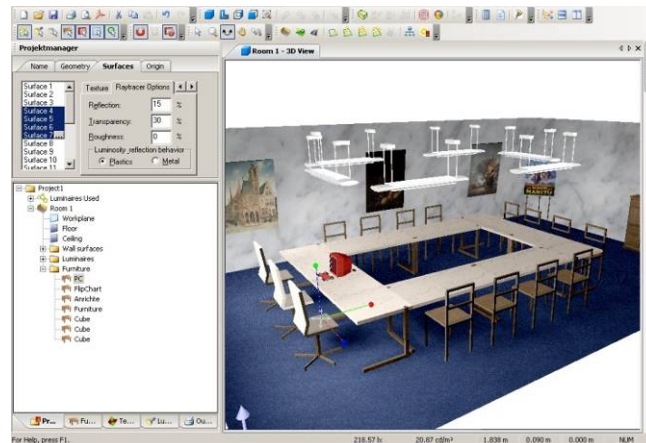

Fig. 518 Raytracing options modify the surfaces

The amount of reflection should be 5 – 10 % for floors and 10 – 15 % for glass. The transparency of glass should be around 30 %.

3-D Standard View for Raytracing

The Raytracing is based on the 3D view of your room or scene, where you can define the point of view, the perspective and the display window of the image.

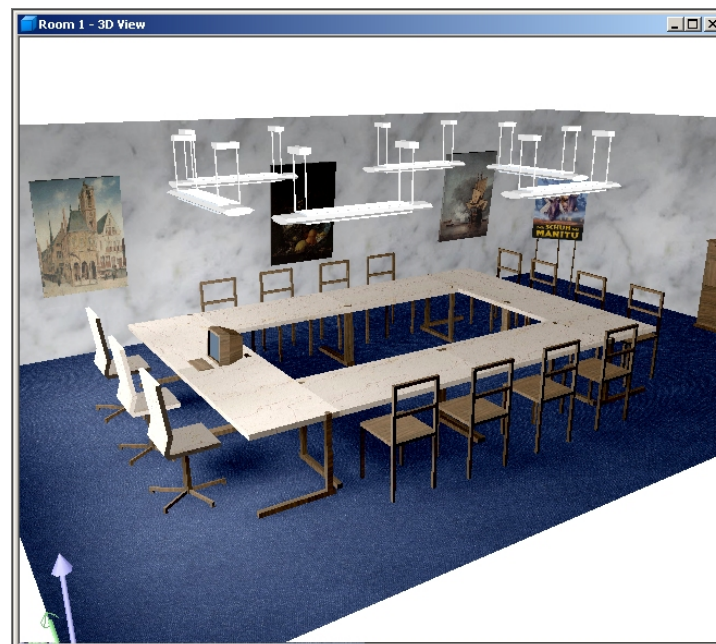

Fig. 519 3D view for the rendering

Starting POV-Ray

After you have adjusted the 3D view you can start POV-Ray from the menu *File* → *Export* → *Calculate CAD view with POV-Ray* or via Raytracer icon.

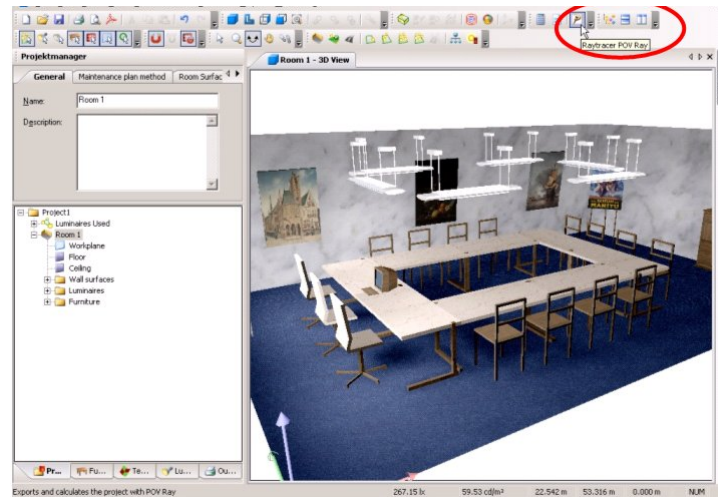

Fig. 520 Start the rendering

If the POV-Ray software is not yet installed, the installation is initiated now. The necessary files have been copied during the installation of DIALux.

If you have further questions you can use the POV-Ray help program, you can find it in the folder at "C:\Program Files\POV-Ray for Windows v3.6" or you can find the information at "<http://www.povray.org>".



Fig. 521 The rendered image

The output of the rendering is a bmp-file that you can print, import into other software or use with an image processing program.

Manipulation of the POV file and editing in POV-Ray

Start of the adapted POV-Ray Version

POV-Ray is freeware, available at www.povray.org. DIAL changed POV-Ray to adapt it to the needs of calculation with "real" luminaires. The POV files created by DIALux can only be modified by the POV-Ray version installed by DIALux. If the user tries to open these files with the regular POV-Ray, an error message will occur. To start the DIAL POV-Ray version, open the PVENGINE.EXE file in your DIALux directory e.g. C:\Program Files\DIALux\ and by a double click.

Smoothing edges

The Anti-aliasing function can be set in DIALux and with more parameters in POV-Ray. To edit a POV file you have to start the POV-Ray program first and then load the *.pov file created by DIALux. The following pictures are showing the same scene without smoothing edges, with the setting switched on in DIALux and with a higher level defined in POV-Ray. This is normally only necessary for small, detailed textures in big distances. Calculation time increases with the level of Anti-aliasing.

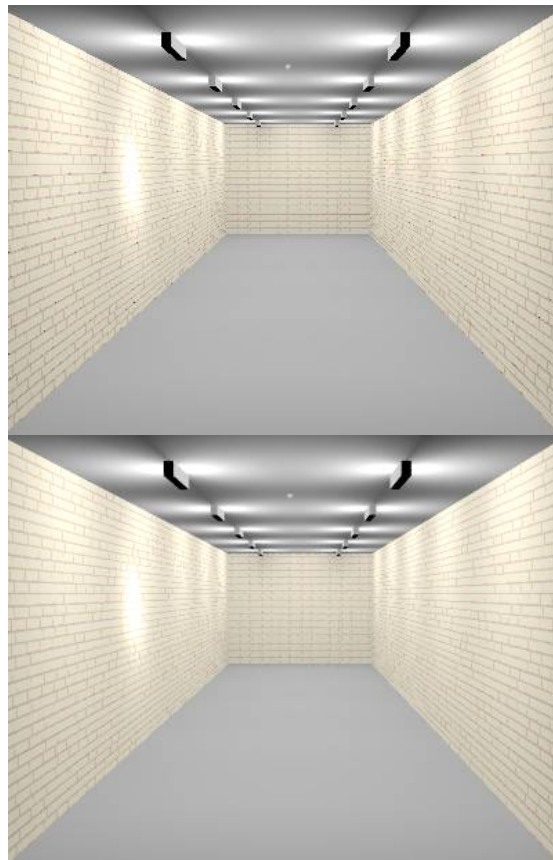



Fig. 522 Smoothing edges

After loading the POV file into the editor, the user can enter additional values for different parameters directly into the edit field in the top middle of the screen. The command for Anti-aliasing is +a followed by a number without a blank e.g. "+a0.001". The lower this value is, the higher the smoothing is.

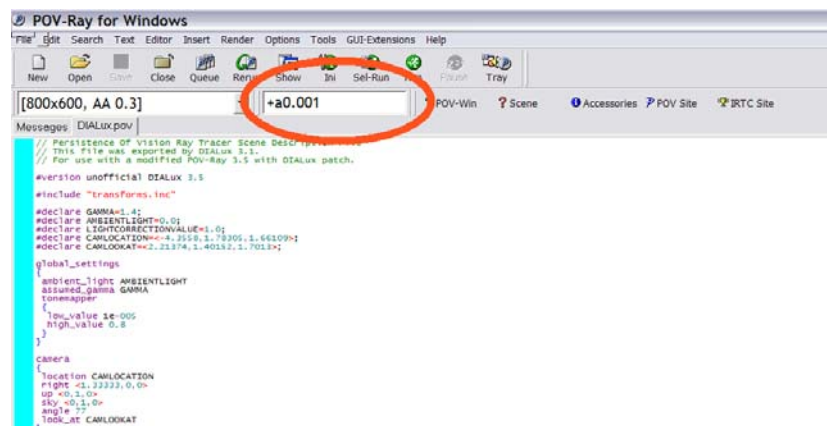

Fig. 523 POV-Ray for Windows

When the POV-Ray editor is started the user can always open the help by pressing F1 to get information for any command.

Picture ratio

Images created by DIALux are always in a ratio of 4:3. This is for the most presentation techniques a good value (TV, projector, monitor,...). Modern laptops or TVs have another ratio e.g. 16:9 and 16:10. After loading the POV file the user can search for the camera command in the text. The search command is one of the drop down menus at the top of the window. In the menu "search" you can select "find" and enter "camera". Below "camera" there is a command for the "right vector" of the used camera. There is written: <1.3333,0,0>. 1.3333 is the ratio 4:3. To achieve a ratio of 16:9 enter there <1.7777> or 16/9 (E.g. right <16/9,0,0>). It is important to define a correct picture size with the same ratio. The

following pictures of the same scene are made in 4:3 and 16:9 ratio. The 4:3 picture has a resolution of 800 by 600 pixel. If you want to keep the height of 600 pixel, you have to multiply the width with the desired ratio. In our example $600 \times 16/9 = 600 \times 1,7777 = 1066$.



Fig. 524 Picture ratio



Fig. 525 Manipulated picture size

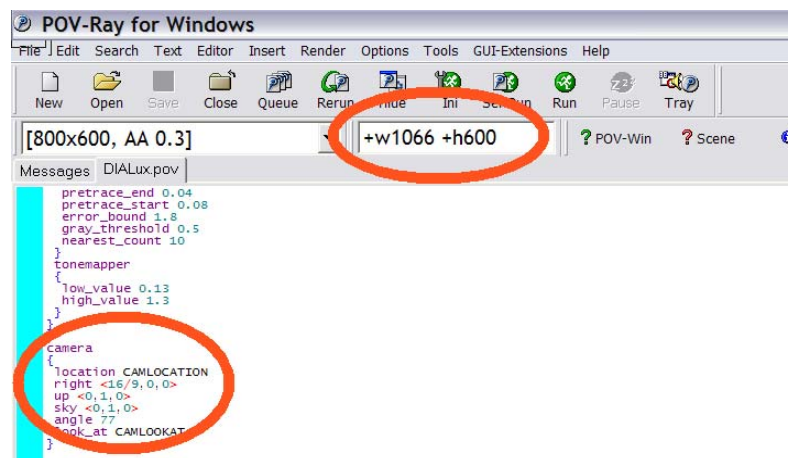

Fig. 526 Change picture size

You can manipulate the picture size by entering the desired size into the edit field with +w and +h directly followed by the numbers. w means width, h means height.

Camera

The camera definition describes the position, projection type and properties of the camera viewing the scene. Interesting types are spherical, cylinder and panoramic. In the POV-Ray help a number of camera types are explained. If none is specified, the perspective camera is the default. The perspective keyword specifies the default perspective camera which simulates the classic pinhole camera. The (horizontal) viewing angle is either determined by the ratio between the length of the direction vector and the length of the right vector or by the optional keyword angle, which is the preferred way. The viewing angle has to be larger than 0 degrees and smaller than 180 degrees. In the "camera" area of the POV file the settings for the camera can be changed.

```
camera
{
location CAMLOCATION // parameter for the
                    // position, is defined in the
                    // beginning of the file

right <16/9,0,0> // right vector of the
camera
up <0,1,0> // up vector of the camera
sky <0,1,0> // Vector for the sky
angle 77 // viewing angle
look_at CAMLOOKAT // viewing direction of the
                    camera
}
```

The primary purpose of the up and right vectors is to tell POV-Ray the relative height and width of the view screen. In the default perspective camera, these two vectors also define the initial plane of the view screen before moving it with the look_at or rotate vectors. The length of the right vector (together with the direction vector) may also be used to control the (horizontal) field of view with some types of projection. The look_at modifier changes both the up and right vectors. The angle calculation depends on the right vector.

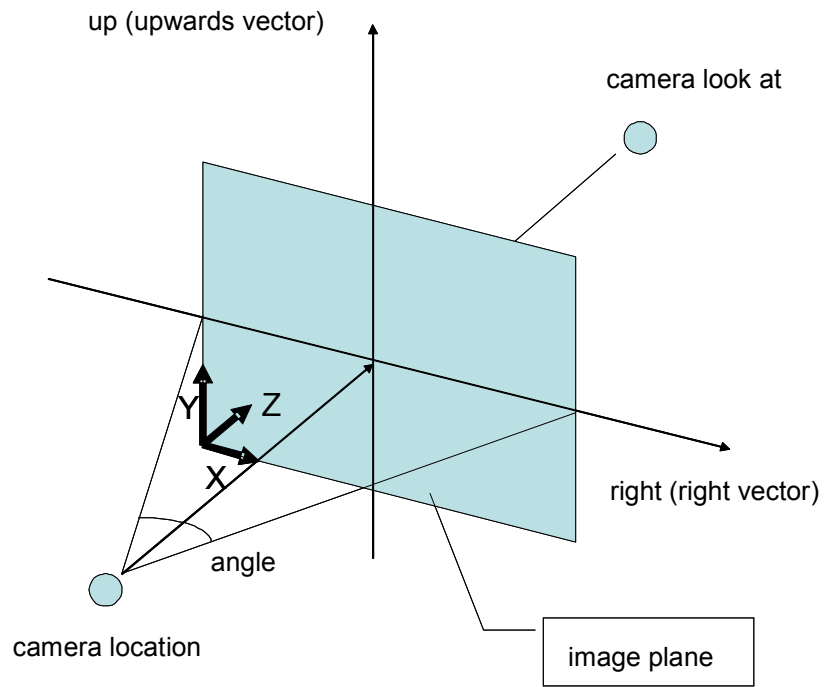

Fig. 527 Camera look and location

This picture shows the definition of the field of view. The blue plane is the image plane. DIALux exports those values as they are defined in the 3D view of the CAD. Depending on the camera type used, those values can differ. See POV-Ray help for more details.

To create a "round view" the camera type "cylinder" is useful. Especially in exterior scenes interesting views can be created. To define such a view the user has to enter the command "cylinder 1" in the area of camera. Use 180° for the angle. It is important to select a correct image size. If you want to have a picture of 500 to 120 the picture ratio has to be 4.2666. The following image is calculated with a 180 degree viewing angle and a cylindrical camera.

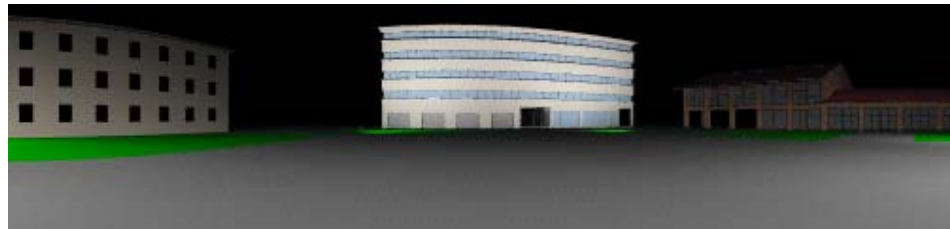

Fig. 528 Exterior scene visualisation

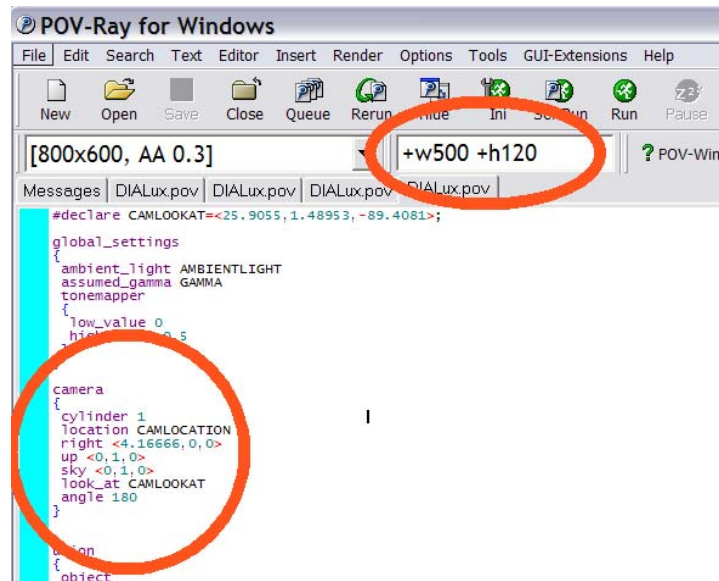

Fig. 529 Settings camera location

Animation

Animation with Keyframes

You can create videos in DIALux with selecting Menu -> File -> Export -> Save 3D Video". You have to define a camera path and several other parameter (see Making videos in DIALux). If you create a PovRay visualisation after defining the camera path, most of the work for making a PovRay video is done. Load the created *.pov file into the PovRay editor. Make sure, that you use the pvenigne.exe in the DIALux subfolder. Look for the green lines in the pov file:

```
// Right click on next line and select "Copy xxx to  
Command-Line" to render animation  
// +KFIO +KFF249
```

As written in the first line, please make a right click on the line // +KFIO +KFF249. Depending on the setting of your animation the values for KFI and KFF can differ.

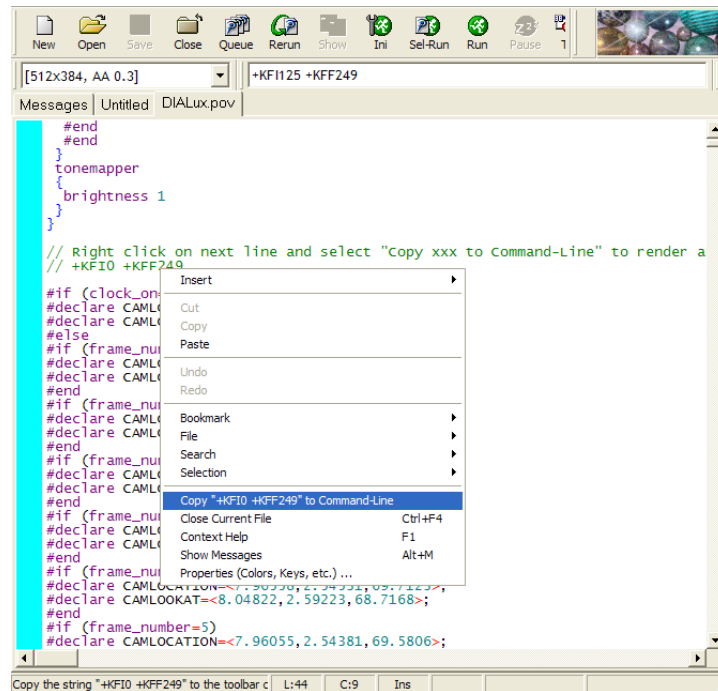

Fig. 530 Starting an animation in PovRay using key frames

Making a right click a context menu appears. Select the "Copy xxx to Command Line" command. This is now written into the command line in the top of the PovRay editor. Clicking on run starts the PovRay raytracing. PLEASE KEEP IN MIND: a 10 second movie with 25 FPS (frames per second) has 250 pictures to be calculated. If one picture takes a minute, you will wait 250 minutes or 4 hours and ten minutes

Animation with the clock parameter

With POV-Ray also animation of scenes can be created. Up to now only static images with fixed camera position and viewing direction have been made. The following settings are defining camera position and viewing direction:

```

#declare CAMLOCATION=<1.5,1.7,2.6>;
#declare CAMLOOKAT=<6.4,1.7,-7.6>;

```

It is important to know, that X, Y and Z are not the same directions as they are in DIALux. Y and Z are changed, compared with DIALux. With the following command lines you can prepare POV-Ray for creating animations.

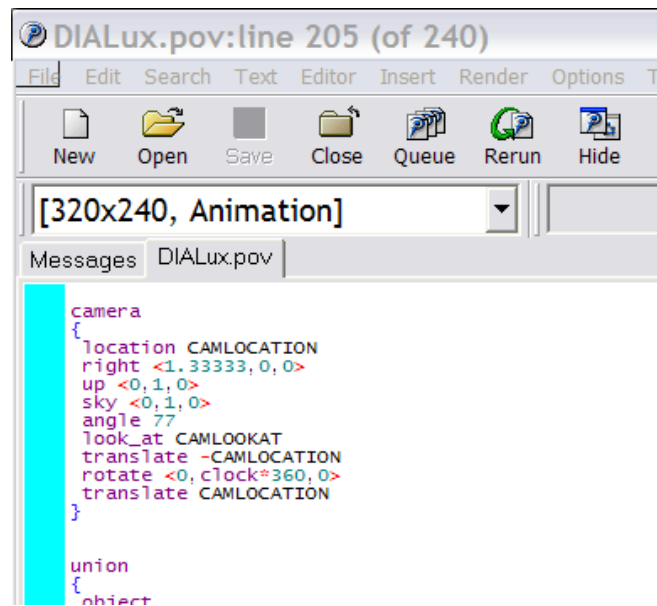

Fig. 531 Animation settings

The camera will be rotated around the upwards axis. Because of that, we will have a look around the room. Rotate $\langle 0, \text{clock} * 360, 0 \rangle$ defines the rotation around the up axis. Remember, Y and Z are exchanged, compared with DIALux. Clock is a counter which is going upwards from 0 to 1. The definition of the clock has to be done in the Ini file of POV-Ray. To do this open the Ini file by clicking on the icon. In this Ini file a section with the correct resolution, anti-aliasing and step width of the clock has to be added. Example:

[320x240, Animation]	Name
Width=320	resolution width
Height=240	resolution height
Antialias=Off	anti-alias switched off
Initial_Frame=1	Image to start with
Final_Frame=25	Image to stop with, defines the number of images
Initial_Clock=0.0	start value of clock
Final_Clock=1.0	stop value of clock

After changing the Ini file, POV-Ray has to be closed and restarted. After the restart of POV-Ray this section can be selected in the top left area of the editor.

Initial_Frame and Final_Frame define the number of pictures to be rendered. In our example there are 25 pictures. Initial_Clock and Final_Clock should be taken without changing. In Europe there are 25 frames per second in PAL format commonly. A 10 seconds lasting film needs 250 pictures (frames). In our example we create 25 pictures, coded as a PAL movie, it will last 1 second. In the POV file we have added the line rotate

<0,clock*360,0>. From "Initial_clock=0" up to "Initial_clock=1" the camera is turned around 360°. POV-Ray creates every $360/25=14.4$ degree a picture. The camera should be turned around its own centre. Therefore it is necessary to translate it into the origin before rotating, otherwise the camera will be rotated around the origin on a circular path. To achieve this you have to enter <translate -camlocation> then <rotate <0,clock*360,0>> then again <translate camlocation> .

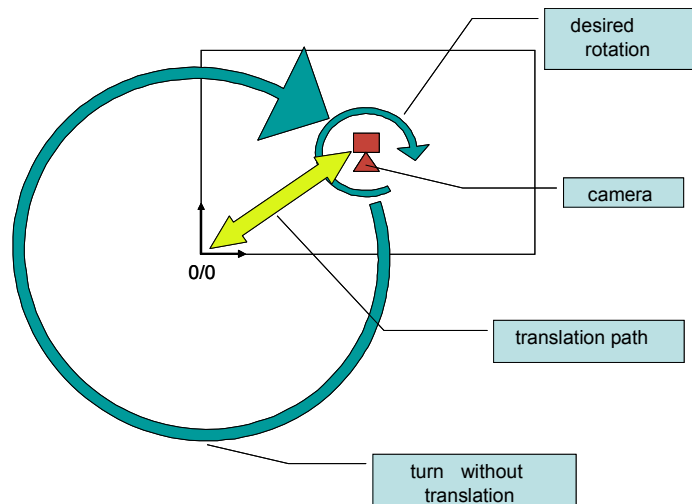

Fig. 532 Camera – Rotation and translation

Each picture will be calculated one after another after clicking on the "Run" icon. Each picture will be saved into the work directory with consecutive numbering. With any animation tool, pictures can be combined to a movie (*.avi, *.mpeg,...) The freeware tool VirtualDub can create such movies in a short time in high quality. <http://www.virtualdub.org/index>

Translation animation

You can define a camera path using clock. To do so, the Ini file and the POV file have to be changed. Instead of the camera rotation you can change the camera location using the clock parameter. In the following example we change the POV file of the first example. The Ini is already changed. The POV file will be changed by adding the clock variable to the X position of the camera location.

```
#declare GAMMA=1.4;
#declare AMBIENTLIGHT=0.0;
#declare LIGHTCORRECTIONVALUE=1.0;
#declare CAMLOCATION=<1.23+clock*11,1.15,3.11>;
#declare CAMLOOKAT=<12.4,1.5,-1.0>;
```

In DIALux the 3D view was turned in that way to enable the camera path to go through the whole room. In the beginning clock=0, that means the position X is 1.23m.

Clock will be counted up in 25 steps from 0 to 1 (value from the Ini file). The X position of the camera changes from 1.23m in the first step to $1.23\text{m} + 1/25 \times 11\text{m} = 1.67\text{m}$ in the second step. The last X position is $1.23\text{m} + 25/25 \times 11\text{m} = 12.23\text{m}$.

The clock variable can be used a number of times in one file. It can be used for translation and rotation in the same animation. So the camera moves along a path turning the viewing direction around its up axis. For example:

```
#declare GAMMA=1.4;
#declare AMBIENTLIGHT=0.0;
#declare LIGHTCORRECTIONVALUE=1.0;
#declare CAMLOCATION=<1.18+clock*11,1.15,3.13>;
#declare CAMLOOKAT=<12.4,1.56,-1.02>;
```

```
global_settings
{
  ambient_light AMBIENTLIGHT
  assumed_gamma GAMMA
```

```
  tonemapper
  {
    low_value 1e-005
    high_value 0.8
  }
}
```

```
camera
{
  location CAMLOCATION
  right <1.33333,0,0>
  up <0,1,0>
  sky <0,1,0>
  angle 77
  look_at CAMLOOKAT
  translate -CAMLOCATION
  rotate<0,180*clock,0>
  translate CAMLOCATION
}
```

In this example the rotation is reduced to 180 degree and it is added to the POV file which already includes the movement of the camera.

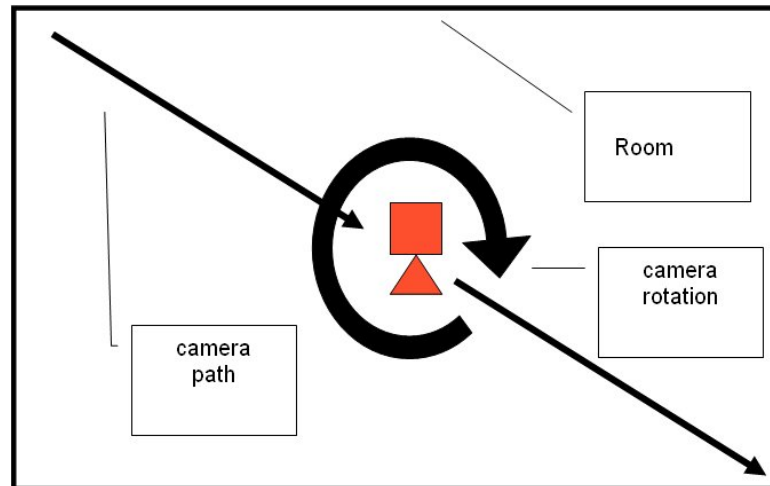

Fig. 533 Movement of the camera

Colour

POV-Ray can calculate coloured light. DIALux will export light colour information of a lightsource in version 3.2. Up to that time, you can create coloured light either by using a transparent, coloured filter glass in front of a luminaire or you can edit the RGB value of a luminaire in the POV file.

To add a "filter glass" in DIALux you have to place a small cube in front of the lightoutput of a luminaire. In the "Raytrace settings" of the geometry you have to define the transparency and the colour of the "filter". It is necessary to remove these filters before calculating with DIALux. DIALux does not yet calculate transparency.

To change the RGB value in the POV file you have to open the file and to find (menu search -> find) ldt_data. The underscore is important!

```
light_source
{
  <0,0,0>
  color <1,1,1>
  ldt_data
  {
    72, 72, 1 * LIGHTCORRECTIONVALUE,
```

color<1,1,1> means the RGB values for the light source are all 100%, means white light. If you change any of these parameters, (e.g. <1,0,1>) the resulting color will be according to the RGB values. This has to be done for each luminaire. It could be helpful to use the replace function (menu search -> replace...)

Further functions of POV-Ray

The following information is an excerpt from the POV-Ray online help you get when you press "F1" after POV-

Ray is started. Furthermore you will find additional information under www.povray.org. Here follows an abstract of the POV-Ray help.

4.2.3 Radiosity without conventional lighting

You can also leave out all light sources and have pure radiosity lighting. The situation then is similar to a cloudy day outside, when the light comes from no specific direction but from the whole sky.

The following 2 pictures show what changes with the scene used in part 1, when the light source is removed. (default radiosity, but `recursion_limit 1` and `error_bound 0.2`)

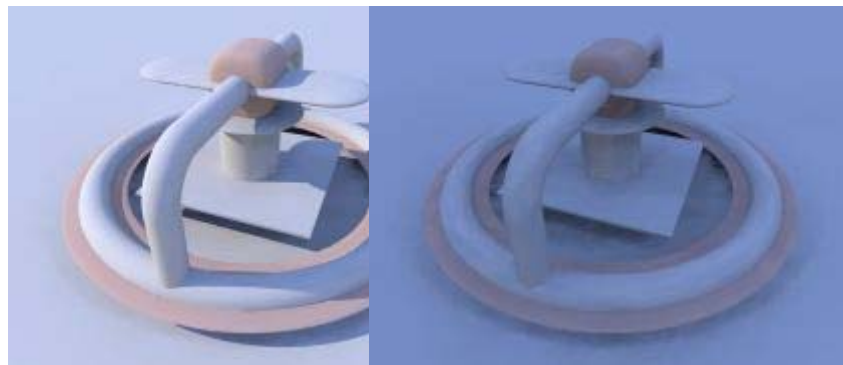

with light source

without light source

You can see that when the light source is removed the whole picture becomes very blue, because the scene is illuminated by a blue sky, while on a cloudy day, the colour of the sky should be somewhere between gray and white.

The following pictures show the sample scene used in this part with different settings for `recursion_limit` (everything else default settings).

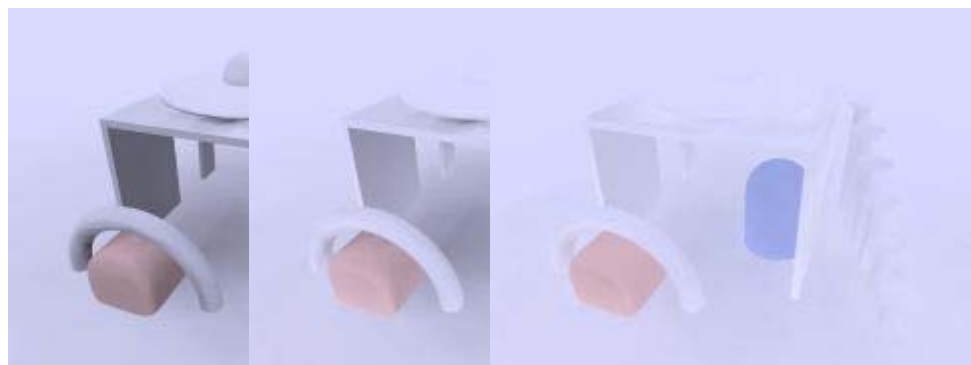

recursion_limit 1

recursion_limit 2

recursion_limit 3

This looks much worse than in the first part, because the default settings are mainly selected for use with conventional light sources.

The next three pictures show the effect of `error_bound`. (`recursion_limit` is 1 here) Without light sources, this is even more important than with good values, much depends on the scenery and the other settings, lower values do not necessarily lead to better results.

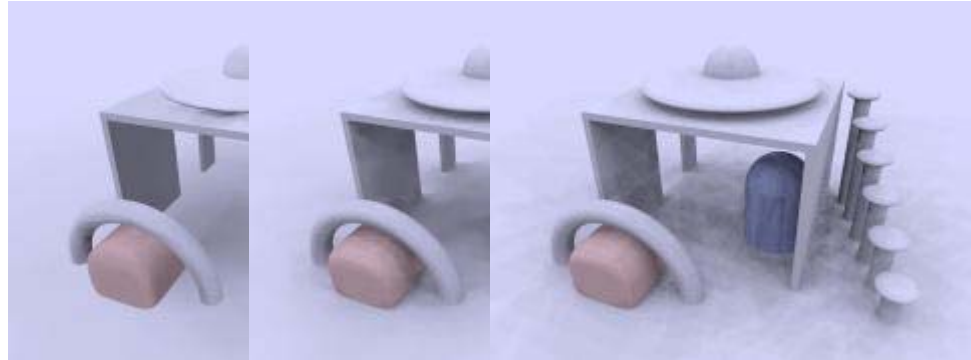

error_bound 1.8 error_bound 0.4 error_bound 0.02

If there are artefacts it often helps to increase `count`, it does affect quality in general and often helps in removing them (the following three pictures use `error_bound 0.02`).

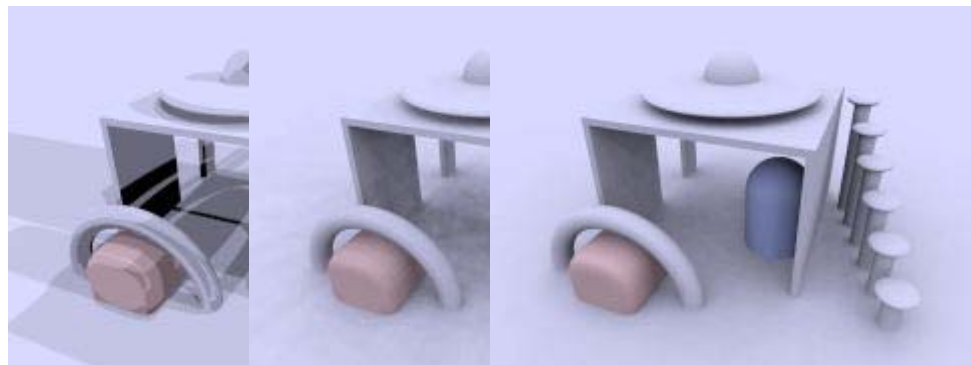

count 2 count 50 count 200

The next sequence shows the effect of `nearest_count`, the difference is not very strong, but larger values always lead to better results (maximum is 20). From now on all the pictures use `error_bound 0.2`

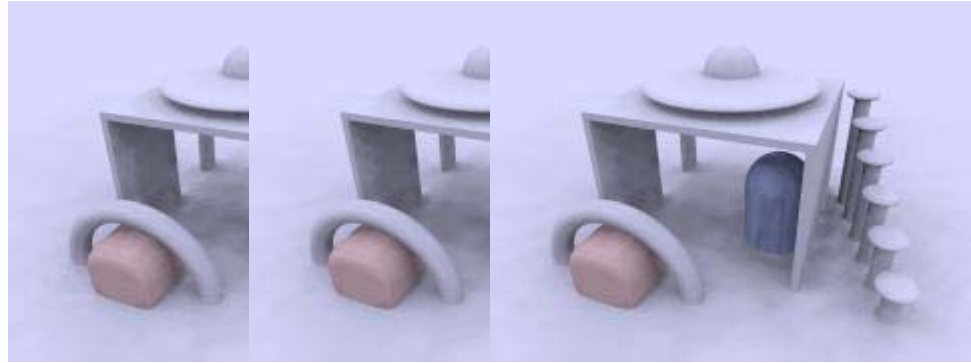

nearest_count 2 nearest_count 5 (default) nearest_count 10

The `minimum_reuse` is a geometric value related to the size of the render in pixel and affects whether previous radiosity calculations are reused at a new point. Lower values lead to more often and therefore more accurate calculations.

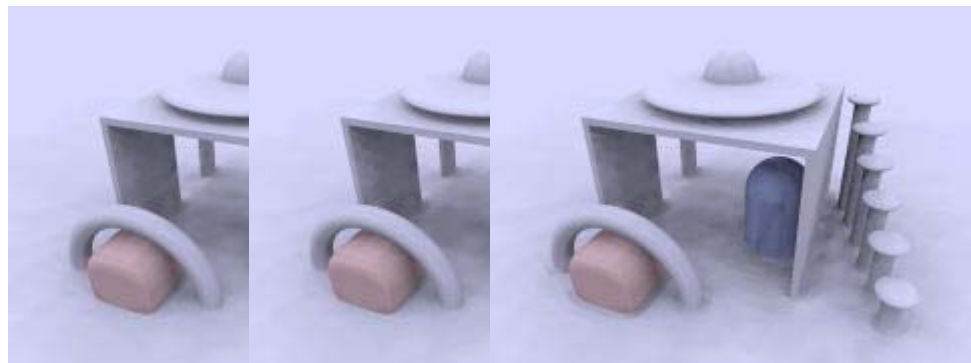

minimum_reuse 0.001 minimum_reuse 0.015 (default) minimum_reuse 0.1

In most cases it is not necessary to change the `low_error_factor`. This factor reduces the `error_bound` value during the final pretrace step. `pretrace_end` was lowered to 0.01 in these pictures, the second line shows the difference to default. Changing this value can sometimes help to remove persistent artefacts.

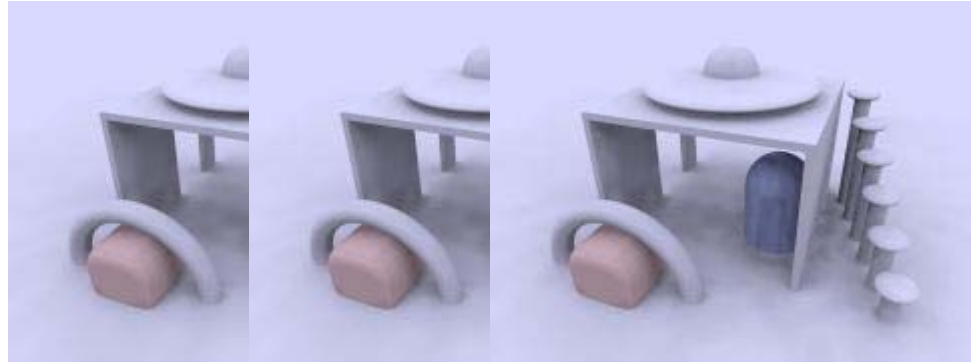

low_error_factor 0.01 *low_error_factor 0.5 (default)* *low_error_factor 1.0*



low_error_factor 0.01 *low_error_factor 1.0*

gray_threshold reduces the colour in the radiosity calculations. As mentioned above the blue sky affects the colour of the whole scene when radiosity is calculated. To reduce this colouring effect without affecting radiosity in general you can increase *gray_threshold*. 1.0 means no colour in radiosity at all.

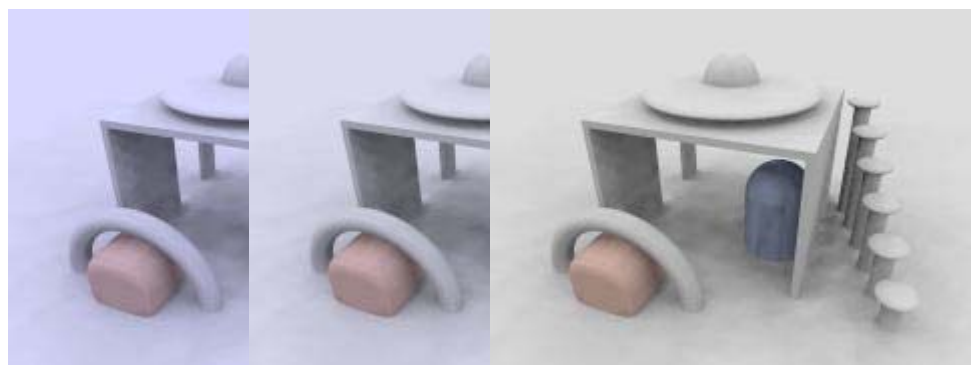

gray_threshold 0.0 *gray_threshold 0.5 (default)* *gray_threshold 1.0*

Another important parameter is *pretrace_end*. Together with *pretrace_start* it specifies the pretrace steps that are done. Lower values lead to more pretrace

steps and more accurate results but also to significantly slower rendering.

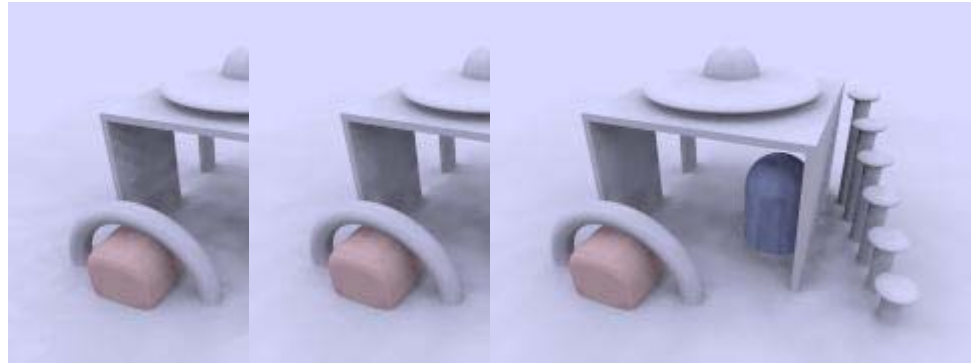

pretrace_end 0.2 pretrace_end 0.02 pretrace_end 0.004

It's worth experimenting with the things affecting radiosity to get some feeling for how things work. The next 3 images show some more experiments.



ambient 3 instead of ambient 0.5 instead of ambient 0 for one object ambient 0 for all objects sky: ambient 0 error_bound 0.04 recursion_limit 2

Finally you can strongly change the appearance of the whole scene with the sky's texture. The following pictures give some example.



yellow-blue gradient light-dark gradient light-dark gradient

from left to right from left to right from bottom to top

Really good results depend a lot on the unique situation and how the scene is meant to look. Here is a “higher quality” rendering of this particular scene, but the requirements can be considerably different in other situations.

```
global_settings {  
  radiosity {  
    pretrace_start 0.08  
    pretrace_end 0.01  
    count 500  
  
    nearest_count 10  
    error_bound 0.02  
    recursion_limit 1  
  
    low_error_factor 0.2  
    gray_threshold 0.0  
    minimum_reuse 0.015  
    brightness 1  
  
    adc_bailout 0.01/2  
  }  
}
```

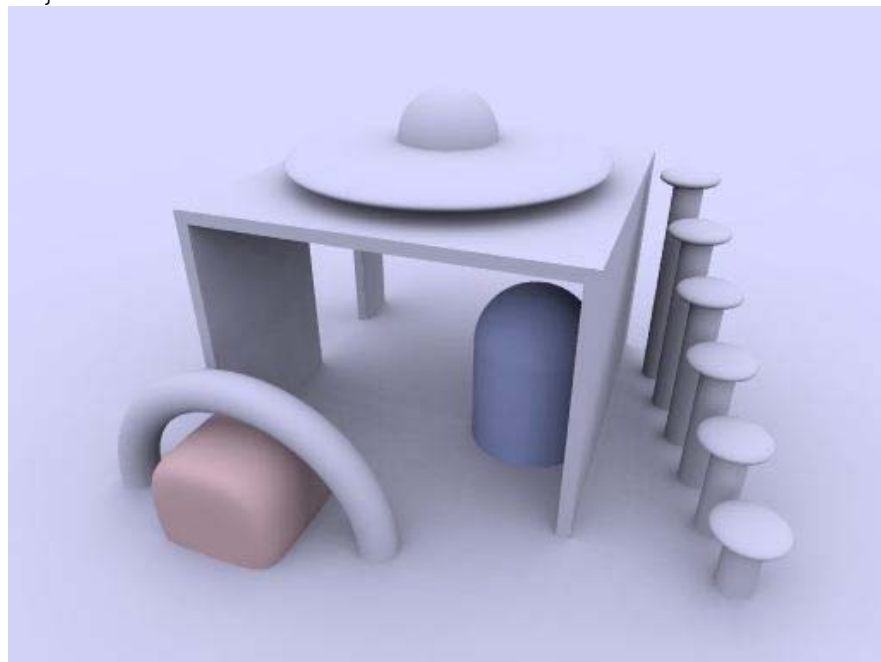

higher quality

List of figures

Fig. 1 DIALux Setup.....	12
Fig. 2 Selection of the components to be installed	13
Fig. 3 DIALux CD browser	13
Fig. 4 DIALux online menu	14
Fig. 5 Online update of luminaire catalogues	16
Fig. 6 DIALux Light Wizard – DIALux Light icon	19
Fig. 7 DIALux Light Wizard – Start	19
Fig. 8 DIALux Light Wizard – Project information.....	20
Fig. 9 DIALux Light Wizard – Data Input.....	20
Fig. 10 DIALux Light Wizard – Launch a PlugIn.....	21
Fig. 11 DIALux Light Wizard – User Database	21
Fig. 12 DIALux Light Wizard – Calculation	22
Fig. 13 DIALux Light Wizard – Calculated Result.....	22
Fig. 14 DIALux Light Wizard – Result Output.....	23
Fig. 15 DIALux Light Wizard – Output	23
Fig. 16 DIALux Light Wizard – End	24
Fig. 17 DIALux Startup Dialogue.....	25
Fig. 18 Launch DIALux Wizard.....	25
Fig. 19 Working with Wizards – Start.....	26
Fig. 20 Working with Wizards – Room Name, Room Form, Room Alignment	27
Fig. 21 Working with Wizards – Room Dimensions	27
Fig. 22 Working with Wizards – Reflection, Work plane, Maintenance Factor.....	28
Fig. 23 Working with Wizards – Luminaire Manufacturer Selection	29
Fig. 24 Working with Wizards – PlugIn / User Database.....	29
Fig. 25 Working with Wizards – Luminaire Selection	30
Fig. 26 Working with Wizards – Mounting height.....	30
Fig. 27 Working with Wizards – Calculate the number of luminaires.....	31
Fig. 28 Working with Wizards – Alignment of the luminaires	31
Fig. 29 Working with Wizards – Calculate result	32
Fig. 30 Working with Wizards – Visually represented result..	32
Fig. 31 Working with Wizards – Single Sheet Output	33
Fig. 32 DIALux user interface.....	34
Fig. 33 3D view of a room.....	35
Fig. 34 Ground plan view of a room.....	35
Fig. 35 Right mouse button.....	36
Fig. 36 3D CAD window context menu	36
Fig. 37 Ground plan view context menu	36
Fig. 38 Context menu of a selected object	37
Fig. 39 Project manager	38
Fig. 40 PlugIn-Tree – Luminaire selection.....	39
Fig. 41 The User Database.....	40
Fig. 42 Explorer context menu whilst DIALux 4.9 is running..	41
Fig. 43 Starting a lamp PlugIn in DIALux.....	42
Fig. 44 DIALux lamp demo database	42
Fig. 45 The Furniture tree.....	44
Fig. 46 The Colour tree	45
Fig. 47 Output Tab.....	46
Fig. 48 Output tree	46
Fig. 49 Save a 3D rendering as *.jpg file.....	47
Fig. 50 The Guide	47
Fig. 51 Display guide window	48
Fig. 52 Property Page of the selected room in the Inspector..	49

Fig. 53 Luminaire arrangement and its luminaires in the project manager.....	49
Fig. 54 Property Page "Position" of the selected luminaire arrangement	49
Fig. 55 Property Page of the luminaires within the selection.....	50
Fig. 56 Room context menu (right-click on room).....	51
Fig. 57 Room edit mode.....	51
Fig. 58 Insert a new corner.....	52
Fig. 59 Edit a ground element.....	52
Fig. 60 Create a polygonal "Task Area" above a desk.....	53
Fig. 61 Taking over the shape of a helpline for the room geometry.....	53
Fig. 62 Menu Settings	54
Fig. 63 General Options – Standard Values	55
Fig. 64 General Options – Global	56
Fig. 65 Automatic reminder to save data.....	56
Fig. 66 Start options.....	57
Fig. 67 Graphic mode	57
Fig. 68 General Options – Output	58
Fig. 69 General Options – Contact	59
Fig. 70 Menu Customise	59
Fig. 71 Reset user interface.....	60
Fig. 72 Create a new project.....	61
Fig. 73 Insert project details	61
Fig. 74 Insert Project data – Location.....	62
Fig. 75 Open a project in the startup dialogue	62
Fig. 76 Open a project in the menu.....	62
Fig. 77 Project preview.....	63
Fig. 78 Edit Rooms – Generate a new room	64
Fig. 79 Edit Rooms – Insert room coordinates.....	64
Fig. 80 Edit Rooms – Zoom to the overall view of the scene	64
Fig. 81 Edit Rooms – 3D view.....	65
Fig. 82 Edit room data – General.....	65
Fig. 83 Edit room data – Maintenance plan method.....	66
Fig. 84 Edit room data – Selection of a reference value for the maintenance factor	66
Fig. 85 Technical data of the placed luminaire.....	67
Fig. 86 Determination of the luminaire number of pieces.....	67
Fig. 87 Output – Maintenance plan.....	68
Fig. 88 Selection of the determination of the enlarged maintenance factor	69
Fig. 89 Technical settings of luminaires with different luminous emittances.....	69
Fig. 90 Determination of the number of required luminaires	70
Fig. 91 Property Page Maintenance factor	71
Fig. 92 User-defined maintenance factors	72
Fig. 93 Insert another arrangement in the same room.....	73
Fig. 94 Show maintenance factors in the CAD via menu	73
Fig. 95 Icon "Show maintenance factors in the CAD"	74
Fig. 96 Menu Edit – Edit Maintenance Factors.....	74
Fig. 97 Context menu of the luminaire arrangement - Edit Maintenance Factors	74
Fig. 98 View of the maintenance factors of individual luminaires in the CAD	75
Fig. 99 Export of the maintenance plan.....	75
Fig. 100 Edit room data – Room surfaces	76
Fig. 101 Edit room data - Alignment	76
Fig. 102 Properties of a wall – Name	77
Fig. 103 Properties of a wall – Material	77
Fig. 104 Inserting a standard element	78

Fig. 105 Edit rooms – Insert room element.....	79
Fig. 106 Edit rooms – Edit room element	80
Fig. 107 Edit rooms – DIALux room elements	80
Fig. 108 DIALux room elements – Vault	80
Fig. 109 DIALux room elements – Dome and half dome.....	81
Fig. 110 Edit rooms – Insert room elements via Property Page	81
Fig. 111 Drag and Drop of furniture.....	82
Fig. 112 Create furniture – Standard bodies.....	82
Fig. 113 Create furniture – Modify the dimensions.....	83
Fig. 114 Create furniture – Copy.....	83
Fig. 115 Create furniture – Combine.....	84
Fig. 116 Create furniture – Export furniture	84
Fig. 117 Create furniture – Saved furniture	85
Fig. 118 Import furniture files.....	85
Fig. 119 Importing 3D wizard.....	86
Fig. 120 Creating an extrusion volume.....	87
Fig. 121 Mask and unmask glass objects.....	87
Fig. 122 Examples for objects of glass (before and after using the Ray-Trace preview)	88
Fig. 123 Subtractions from a volume.....	89
Fig. 124 Resulting volume	89
Fig. 125 Selecting specific surfaces from a volume	90
Fig. 126 Drag & drop for windows and doors	90
Fig. 127 Context menu – decoration object	91
Fig. 128 Decoration object in the project tree	92
Fig. 129 Calculation dialogue.....	92
Fig. 130 Insert textures via Drag & Drop.....	93
Fig. 131 Edit textures on an object.....	94
Fig. 132 Delete textures	94
Fig. 133 Import textures into DIALux.....	95
Fig. 134 Opening the material dialogue of a surface	96
Fig. 135 Selection of the Raytrace preview	98
Fig. 136 Raytrace preview parameters.....	98
Fig. 137 Output of the Raytrace preview.....	99
Fig. 138 Duplicate rooms	100
Fig. 139 Launch luminaire tree.....	101
Fig. 140 Launch online catalogues	102
Fig. 141 Insert individual luminaires.....	103
Fig. 142 Luminaire selection dropdown list	103
Fig. 143 Mounting tab	104
Fig. 144 Modifying the technical data of luminaires	104
Fig. 145 Help rays for luminaires	105
Fig. 146 Luminaries with 3D LDC	105
Fig. 147 Mouse mode to define illumination point.....	106
Fig. 148 Selection of individual luminaires.....	106
Fig. 149 Align a spotlight to a picture	107
Fig. 150 Insert luminaire fields without wizard	107
Fig. 151 Manipulating a luminaire within an arrangement .	108
Fig. 152 Selecting the arrangement type of a luminaire field	109
Fig. 153 Effect of arrangement type and dimensioning type on the luminaire field dimensions.....	109
Fig. 154 Luminaire field insert frames depending on the arrangement type.....	110
Fig. 155 Luminaires used in the arrangement.....	110
Fig. 156 Rotating the arrangement and the luminaires.....	111
Fig. 157 Luminaire field position	111
Fig. 158 Scale a luminaire line.....	112
Fig. 159 Edit a luminaire line.....	112

Fig. 160 Aligning individual luminaires within an arrangement	113
Fig. 161 Selection filter for CAD selection	113
Fig. 162 Luminaire circle start and end angle	114
Fig. 163 Inserting floodlight illumination in a sports complex	115
Fig. 164 Settings options in the project manager	115
Fig. 165 Mirroring options for floodlight illumination	116
Fig. 166 Options for changing the illumination points	117
Fig. 167 Moving an illumination point manually.....	117
Fig. 168 Cancelling the symmetry of floodlight illumination	117
Fig. 169 Individually adjustable luminaire positions after cancelling the symmetry	118
Fig. 170 Transforming a single luminaire into an individual arrangement.	118
Fig. 171 Modify luminaire data – Corrections.....	119
Fig. 172 Modify luminaire data – Mounting height	119
Fig. 173 Selection of rotatable luminaire parts	119
Fig. 174 Turn the rotatable luminaire part by mouse pointer	120
Fig. 175 Align the rotatable luminaire part.....	120
Fig. 176 Symbol for luminaires with several articulated joints	120
Fig. 177 Context menu of the unrestricted luminaire arrangement	121
Fig. 178 Modify the new luminaire arrangement.....	121
Fig. 179 Remove from luminaire group	122
Fig. 180 Aligning luminaire arrangements – Context menu	122
Fig. 181 Set illumination point – Aligned luminaire field.....	123
Fig. 182 Selection of a direct planar lighting situation	124
Fig. 183 Alternative solution to insert a direct planar lighting situation	124
Fig. 184 Insertion of selected luminaries into the direct planar lighting situation	125
Fig. 185 Insertion of additional points to the lighting situation	125
Fig. 186 Changes in Mounting Height (1), Arrangement of luminaries (2) and Rotations of single luminaries (3) at vertical planar lighting solutions	126
Fig. 187 Editing the single axes – direct planar lighting	126
Fig. 188 Selection of a vertical planar lighting situation	127
Fig. 189 Alternative solution to insert a vertical planar lighting situation	127
Fig. 190 Insertion of selected luminaries into the vertical planar lighting solution	128
Fig. 191 Changes in Mounting Height (1), Arrangement of luminaries (2) and Rotations of single luminaries (3) at vertical planar lighting solutions	128
Fig. 192 Editing the single axes – vertical planar lighting	129
Fig. 193 Spectral light calculation.....	130
Fig. 194 Non spectral light calculation.....	131
Fig. 195 Light colours in the DIALux colour tree	132
Fig. 196 Colour information for a selected spectrum.....	132
Fig. 197 Colour rendering indices of the CIE test colours (CIE 13.3)	133
Fig. 198 Spectra and colour rendering properties of different light sources	133
Fig. 199 Drag and Drop of a spectrum onto a luminaire with rotatable elements.....	134

Fig. 200 Drag and drop of a filter / spectrum, while holding down the control key	135
Fig. 201 Drag and drop of a spectrum / filter on a rotatable element of a luminaire while holding down the shift key	135
Fig. 202 Spectrum of the lamp, the filter and the resulting radiation. Click on the triangle on the bottom right to get the Ra values.	136
Fig. 203 Technical information of colour filter	137
Fig. 204 Resulting spectrum of a luminaire with two times the same filter but different light sources	137
Fig. 205 All the spots are using the same colour filter, but have different light sources. From the left: Incandescent, Flourescent 830, D65, high pressure sodium, metal halide ceramic and metal halide quartz.....	138
Fig. 206 Four identical photos using different values for the white balance (Source: wikipedia, foto Thomas Steiner).....	138
Fig. 207 Adjusting the white balance	139
Fig. 208 Paste a control group via menu	141
Fig. 209 Paste a control group – Context menu of the room	141
Fig. 210 Paste a control group – Context menu in the CAD view	141
Fig. 211 Property Page of a control group.....	142
Fig. 212 Insert a light scene via menu.....	142
Fig. 213 Context menu of the room – Insert a light scene ..	143
Fig. 214 Context menu control group – Add to light scene	143
Fig. 215 Property Page of a light scene – Light scene	144
Fig. 216 Property Page of a light scene – Daylight factors...	144
Fig. 217 Property Page of a light scene – Dimming values ..	145
Fig. 218 Property Page of a control group – Dimming values	145
Fig. 219 Icons for showing dimming values and light scenes in CAD	145
Fig. 220 Viewable dimming values in CAD	146
Fig. 221 Dimming individual light outputs separately	147
Fig. 222 Duplicate light scene or control group.....	147
Fig. 223 Adjust brightness via menu.....	148
Fig. 224 Adjust brightness – CAD window	148
Fig. 225 Brightness control for 3D rendering.....	149
Fig. 226 Extended settings	149
Fig. 227 Export of light scenes	149
Fig. 228 Types of emergency lighting.....	150
Fig. 229 Emergency lighting scene	151
Fig. 230 Property Page of emergency lighting	151
Fig. 231 Output – Emergency lighting data sheet.....	152
Fig. 232 Emergency lighting – Modify escape route	153
Fig. 233 Emergency lighting – Insert escape route lighting .	153
Fig. 234 Escape route lighting.....	154
Fig. 235 Escape route lighting – Visualisation	154
Fig. 236 Open area lighting.....	155
Fig. 237 Insert open area lighting.....	155
Fig. 238 Properties of the open area luminaire arrangement	156
Fig. 239 Calculation dialogue – Without furniture.....	156
Fig. 240 Emergency luminaires in the CAD view.....	157
Fig. 241 Emergency lighting – Inspector.....	157
Fig. 242 Emergency lighting data sheet.....	158

Fig. 243 Specify dimming values of the control group	160
Fig. 244 Select the location	161
Fig. 245 North alignment	161
Fig. 246 Edit daylight factors	162
Fig. 247 Daylight factors	162
Fig. 248 Output – Value chart of the workplane	163
Fig. 249 Obstruction in CAD view	164
Fig. 250 Sun and shadow visualisation	164
Fig. 251 Calculation dialogue	165
Fig. 252 Evaluating a staircase from the upper storey	166
Fig. 253 Toolbar for switching between modes	166
Fig. 254 Change perspective and focal distance of the camera	167
Fig. 255 Show calculation results in 3D view	168
Fig. 256 Save a 3D view as *.jpg-file	168
Fig. 257 Open the 3D rendering	169
Fig. 258 Copy the 3D rendering into another software	169
Fig. 259 False colour – Illuminances	170
Fig. 260 False colour – Luminance	170
Fig. 261 Views toolbar	171
Fig. 262 Working in various views	171
Fig. 263 Multiple view arrangement	171
Fig. 264 Closing CAD windows	172
Fig. 265 Save camera view via context menu	172
Fig. 266 Save camera view via menu	173
Fig. 267 Redo camera view – Redo positions	173
Fig. 268 Changing into the wireframe mode	174
Fig. 269 Graphically modifying the object height	175
Fig. 270 Dragging an object by its corners and automatic rotation	176
Fig. 271 Fading out objects	177
Fig. 272 Fading in objects	177
Fig. 273 Pick grid settings – Display Grid	178
Fig. 274 Pick grid settings – Snap Grid	178
Fig. 275 Pick grid settings – Angle Pick	178
Fig. 276 Pick grid settings – Colours of the Pick grids	179
Fig. 277 Rotating objects	179
Fig. 278 Object context menu	180
Fig. 279 Combining Objects	180
Fig. 280 Specify the coordinate origin	181
Fig. 281 Coordinate origin which was moved outside the cube	182
Fig. 282 Resetting the rotation of the origin of an object or furniture	182
Fig. 283 Editing surfaces	183
Fig. 284 Calculating grid and furniture surface output	183
Fig. 285 Selecting a single surface with the mouse	184
Fig. 286 The tape measure icon	185
Fig. 287 The tape measure function in the ground plan view	185
Fig. 288 The tape measure function in the 3D view	185
Fig. 289 Fixed grid with a spacing of 0.5m in X and Y direction	186
Fig. 290 Automatically by the walls generated temporary help lines	186
Fig. 291 Automatically by an object generated temporary help lines	187
Fig. 292 Creating helping areas in the ruler	187

Fig. 293 In the left sketch the object is moved on its origin, on the right it is moved on the bounding box. In the second case the rotation is adjusted.	188
Fig. 294 Icons to insert help lines	188
Fig. 295 Further editing of a help line.....	189
Fig. 296 Icons to switch on and off the snap to help lines ..	189
Fig. 297 Inserting a help line	189
Fig. 298 Display help lines	190
Fig. 299 Insert a poly line, stop the mode with a right click	190
Fig. 300 Move the complete poly line by holding down the ALT key	191
Fig. 301 A closed spline help line. In the start and end point are draggers to change the line	191
Fig. 302 Move the complete poly line by holding down the ALT key	192
Fig. 303 Copy along a help line with the mouse.....	192
Fig. 304 Mouse symbol to select a help line for copying.....	192
Fig. 305 Copying in the standard setting with placing objects in the vertex	193
Fig. 306 Copying along a help line with fixed distance	193
Fig. 307 Insert a help grid	194
Fig. 308 Defining a help grid.....	194
Fig. 309 Snap points on the help.....	194
Fig. 310 Copy along a line with the mouse	195
Fig. 311 Copy along a line with the inspector	196
Fig. 312 Context menu CAD – Align and distribute.....	196
Fig. 313 Menu Edit – Align and distribute	197
Fig. 314 Align and distribute – centred in space	197
Fig. 315 Inserting calculation surfaces or task areas.....	198
Fig. 316 Transparent calculation surfaces	198
Fig. 317 Different types of illuminance	199
Fig. 318 Property Page of calculation surface – Selection of the types of illuminance	199
Fig. 319 Edit work area and surrounding area.....	200
Fig. 320 Inserting a calculation grid via the project manager	201
Fig. 321 Inserting a calculation grid via the menu.....	202
Fig. 322 Types of calculation grids.....	202
Fig. 323 Converting the calculation grid.....	203
Fig. 324 Editing grid points	203
Fig. 325 Changing individual grid points by using coordinates	204
Fig. 326 Selecting scaling options.....	204
Fig. 327 Step-by-step procedure for merging calculation grids	205
Fig. 328 Methods for defining calculation points.....	206
Fig. 329 Aligning the grid points to the edges of the axes..	207
Fig. 330 Inspector “Calculation grid” for radial calculation grids.....	207
Fig. 331 Creating a measuring grid	208
Fig. 332 Pre-setting the calculation of the calculation grid..	209
Fig. 333 Setting limit values for gradients.....	209
Fig. 334 Changing an output option - Display values	210
Fig. 335 Procedure and values in real time calculation.....	211
Fig. 336 Camera-oriented luminous intensity – selection and settings	211
Fig. 337 CAD output of camera-oriented luminous intensity	212
Fig. 338 Displaying isolines in CAD.....	212
Fig. 339 Selecting an isoline profile	213

Fig. 340 Calculation points.....	213
Fig. 341 Insert UGR objects into a room.....	215
Fig. 342 Viewing direction of an UGR observer	215
Fig. 343 Startup dialogue	216
Fig. 344 Start DIALux 4.9 with a new exterior scene.....	216
Fig. 345 Insert a ground element from the furniture tree via "Drag & Drop"	217
Fig. 346 A ground element	217
Fig. 347 Calculate results of a surface	218
Fig. 348 Illumination of a facade with a calculation surface in front of it	219
Fig. 349 Property page of the GR Observer	219
Fig. 350 Luminous flux that is taken into account for the ULR value	221
Fig. 351 Luminous intensity calculation point.....	221
Fig. 352 Property page for the outputs of the luminous intensity calculation point.....	221
Fig. 353 Calculation surface Street-valuation field.....	222
Fig. 354 Simple Street-valuation field in an exterior scene ..	223
Fig. 355 Complex Street-valuation field in an exterior scene	223
Fig. 356 Startup dialogue DIALux – New street project.....	224
Fig. 357 Insert Standard Street via menu	224
Fig. 358 Insert Standard Street via "The Guide"	225
Fig. 359 Planning with standards for road lighting	225
Fig. 360 American standard of C0-plane.....	226
Fig. 361 European standard of C0-plane.....	226
Fig. 362 IES-file import.....	226
Fig. 363 LDC rotation.....	227
Fig. 364 Insert a new standard street	227
Fig. 365 luminance conditions.....	228
Fig. 366 maintenance plan method.....	228
Fig. 367 Insert and arrange the street elements.....	229
Fig. 368 Insert street elements via menu	229
Fig. 369 Insert street elements via context menu.....	230
Fig. 370 Properties of a roadway – General.....	230
Fig. 371 Properties of a roadway – Street coating	231
Fig. 372 Properties of a roadway – Observer	231
Fig. 373 Properties of a roadway – Surfaces	232
Fig. 374 Insert valuation field via context menu.....	232
Fig. 375 Common valuation field	233
Fig. 376 Calculation Grid	233
Fig. 377 Calculation Grid – Illuminance Class	234
Fig. 378 Additional lightning classes.....	234
Fig. 379 Method selection.....	236
Fig. 380 Insert street arrangement via "The Guide"	236
Fig. 381 Insert street arrangement via menu	237
Fig. 382 Insert street arrangement via right mouse button .	237
Fig. 383 Insert Street Arrangement – Luminaire	238
Fig. 384 Insert Street Arrangement – Boom properties and pole arrangement	238
Fig. 385 Insert Street Arrangement – Arrangement.....	239
Fig. 386 Street arrangement – Optimise arrangement.....	239
Fig. 387 Calculation field in the ground plan view.....	240
Fig. 388 3D visualisation of the street	240
Fig. 389 2D visualisation of the street	241
Fig. 390 Insert street into exterior scene.....	241
Fig. 391 Street in an exterior scene	242
Fig. 392 DIALux wizards – Quick street-planning wizard.....	242
Fig. 393 Wizards via Menu.....	242
Fig. 394 Startup dialogue for street light wizard.....	243

Fig. 395 Street profile	243
Fig. 396 Valuation Fields and Illumination Classes	244
Fig. 397 Valuation Fields and Illumination Classes	244
Fig. 398 Limit values for the optimisation	245
Fig. 399 Substitute list.....	245
Fig. 400 Luminaire selection.....	246
Fig. 401 Variable arrangement parameters.....	247
Fig. 402 Positioning suggestions	247
Fig. 403 CSV Export	248
Fig. 404 Saving all adjusted parameters	248
Fig. 405 Final dialogue	249
Fig. 406 Wizard Optimised street light arrangement	250
Fig. 407 Context menu luminaire arrangement.....	250
Fig. 408 "The Guide" of optimised luminaire arrangement	251
Fig. 409 Load value settings.....	251
Fig. 410 Start Illumination Conditions Wizard	252
Fig. 411 Illumination Conditions Wizard – Welcome dialogue	252
Fig. 412 Illumination Conditions Wizard – Typical Speed....	253
Fig. 413 Illumination Conditions Wizard – Main Users and Other Users	253
Fig. 414 Illumination Conditions Wizard – Final dialogue....	254
Fig. 415 Start Illumination Class Wizard	254
Fig. 416 Illumination Class Wizard – Welcome dialogue	255
Fig. 417 Illumination Class Wizard – Typical Speed.....	255
Fig. 418 Illumination Class Wizard – Main Users and Other Users	256
Fig. 419 Illumination Class Wizard – Main Weather Type ...	256
Fig. 420 Illumination Class Wizard – Interchanges	257
Fig. 421 Illumination Class Wizard – Traffic Flow of Motorised Vehicles.....	257
Fig. 422 Illumination Class Wizard – Conflict Zone	258
Fig. 423 Illumination Class Wizard – Complexity of Field of Vision	258
Fig. 424 Illumination Class Wizard – Degree of Navigational Difficulty.....	259
Fig. 425 Illumination Class Wizard – Brightness of Surroundings.....	259
Fig. 426 Illumination Class Wizard – Final dialogue	260
Fig. 427 Importing your own R-table.....	260
Fig. 428 Selecting an R- table and inserting this in DIALux .	261
Fig. 429 Inserting a sports complex via the guide	262
Fig. 430 Inserting a sports complex via the menu	263
Fig. 431 Selecting a sports complex.....	263
Fig. 432 Opening the project manager for editing a sports complex	264
Fig. 433 Inserting sports field elements	264
Fig. 434 Start flood light table.....	265
Fig. 435 flood light table for sport complex.....	265
Fig. 436 Inserting a pole position with the Inspector	266
Fig. 437 Aligning a TV camera	267
Fig. 438 Example of outputs for a sports complex	268
Fig. 439 Output settings	269
Fig. 440 Output header line	269
Fig. 441 Global settings	270
Fig. 442 Monitor output of a big table	271
Fig. 443 Print preview generation status	272
Fig. 444 Print preview	272
Fig. 445 Limit result output.....	273
Fig. 446 Output settings	273

Fig. 447 3D CAD at the top left (for editing purposes) and 3D rendering (as output) at the bottom right....	274
Fig. 448 Output of a light scene.....	274
Fig. 449 Settings of luminaire data sheet	275
Fig. 450 Luminance diagram for evaluation of omni directional glare control.....	276
Fig. 451 Light intensity table	276
Fig. 452 Property page output exterior scene	277
Fig. 453 Creating standard outputs.....	277
Fig. 454 Export the output to a PDF-file	278
Fig. 455 Export the output table to a file or copy it into the clipboard	279
Fig. 456 Export the output graphic to a file or copy it into the clipboard	279
Fig. 457 Export of output graphics to other programmes... ..	280
Fig. 458 DWG / DXF Import options	281
Fig. 459 DWG / DXF settings.....	282
Fig. 460 Move the dwg / dxf-origin with mouse and context menu	282
Fig. 461 Drag the corners to align the room with the drawing	283
Fig. 462 Insert doors, windows, furniture.....	283
Fig. 463 Using 2D projection of dwg / dxf in 3D view.....	284
Fig. 464 3D view with DXF background	284
Fig. 465 General settings for the DWG/DXF export	285
Fig. 466 Object selection	285
Fig. 467 Selection of the current layers and designations ...	286
Fig. 468 Options for the export.....	286
Fig. 469 Settings for the luminaire export	287
Fig. 470 Definition of the luminaires' legend.....	288
Fig. 471 DWG and DXF export - Isolines.....	288
Fig. 472 Export of the value chart in dxf and dwg.....	289
Fig. 473 Importing gbXML	290
Fig. 474 Room overview in the project manager of agbXML file	291
Fig. 475 Insertion of an energy evaluation project into a DIALux project via menu "Paste" and via the context menu of the DIALux project.....	293
Fig. 476 Energy evaluation project in project tree.....	294
Fig. 477 Transfer of all DIALux-rooms into the energy evaluation project.....	294
Fig. 478 Transfer of one single DIALux room into the energy evaluation project.....	295
Fig. 479 Multi-consideration of one energy evaluation room during the evaluation of the complete energy performance project.....	295
Fig. 480 Multiple energy evaluation rooms and there utilisation zones	296
Fig. 481 An energy evaluation room with a selection of utilisation zones, to which it can be moved .	296
Fig. 482 Energy evaluation room in project tree with its assessment zones	296
Fig. 483 Display of assessment zones in CAD-windows (second icon from the left)	297
Fig. 484 Display of assessment zones of an energy evaluation room in 3D-view.....	297
Fig. 485 Energy evaluations in The Guide.....	298
Fig. 486 Create an energy evaluation room with a link to a DIALux room.	298

Fig. 487 Create an energy evaluation room without a link to a DIALux room	299
Fig. 488 Energy evaluation rooms with and without link to DIALux rooms.....	299
Fig. 489 Possibility to change the linked DIALux room for an energy evaluation room.....	300
Fig. 490 Possibility to cancel the link of an energy evaluation room to a DIALux room.....	301
Fig. 491 Working on the assessment zone of an unlinked energy evaluation room.....	301
Fig. 492 Utilisation profile of an utilisation zone in a planning according to DIN 18599	302
Fig. 493 One property page of a daylight supplied assessment zone.....	303
Fig. 494 Property pages for assessment zones, that are daylight supplied by windows respectively roof lights	303
Fig. 495 Direct input of energy consumption values in unlinked energy evaluation rooms	303
Fig. 496 Occupancy parameters of an assessment zone in EN 15193 (left) and in DIN 18599 (right).....	304
Fig. 497 Start of an energy evaluation in menu „Output“ ..	305
Fig. 498 Start of an energy evaluation with the icon of the same name (second from left)	305
Fig. 499 An assessment zone that is added to another assessment zone.....	306
Fig. 500 An assessment zone that is added to the super ordinate utilisation zone	306
Fig. 501 Outputs for an energy evaluation	307
Fig. 502 Output for the complete energy evaluation project with all important characteristics	307
Fig. 503 Property page of the above output page	308
Fig. 504 Parameter output for an assessment zone	308
Fig. 505 Input of a description for an assessment zone	308
Fig. 506 Inserting a camera path in the 3D view.....	309
Fig. 507 Inserting additional camera positions along the path	309
Fig. 508 Deleting camera positions.....	310
Fig. 509 Defining the camera viewing direction.....	310
Fig. 510 Settings of the video.....	311
Fig. 511 Windows dialog for the video compression settings	312
Fig. 512 Basic settings for Raytracing	314
Fig. 513 Smoothing edges with POV-Ray	315
Fig. 514 POV Ray – Image preferences	316
Fig. 515 POV Ray – Indirect calculation.....	317
Fig. 516 Indirect calculation	318
Fig. 517 POV Ray – Brightness preferences.....	319
Fig. 518 Raytracing options modify the surfaces.....	320
Fig. 519 3D view for the rendering.....	320
Fig. 520 Start the rendering	321
Fig. 521 The rendered image	321
Fig. 522 Smoothing edges	323
Fig. 523 POV-Ray for Windows	323
Fig. 524 Picture ratio.....	324
Fig. 525 Manipulated picture size.....	324
Fig. 526 Change picture size	324
Fig. 527 Camera look and location.....	326
Fig. 528 Exterior scene visualisation.....	326
Fig. 529 Settings camera location.....	327
Fig. 530 Starting an animation in PovRay using key frames .	328

Fig. 531 Animation settings	329
Fig. 532 Camera – Rotation and translation	330
Fig. 533 Movement of the camera	332

Index

*.jpg	168
3D rendering.....	46
save as picture	46
alignment	159
alignment of luminaires	106
angle of radiation	275
Angle Pick.....	179
arrangement.....	110
bicycle lane	228
<i>Boom</i>	238
brightness.....	148
CO plane	105
calculating grid	182
calculation	46
calculation grid	241, 259, 274
calculation results.....	183
calculation surface	
Surrounding area	200
Calculation surface	
work area	200
CIBSE TM14.....	41
context menu.....	36
Control Groups.....	140
coordinate arrows.....	57
coordinate origin.....	179
daylight.....	144
daylight calculation	61, 160
<i>Daylight factors</i>	144
daylight obstruction	159
Delete Coordinates	52
DIALux Light Control	149
dimming values.....	140
DVD or S-VCD.....	311
DWG and DXF	
DWG or DXF Import.....	281
DXF.....	281
Edit Calculation Surface	50
Edit Ground Element.....	50
Edit Room Geometry.....	50
End Angle	113
Eulumdat	40, 41
export	
output graphics.....	279
furniture	
save furniture	180
<i>furniture tree</i>	44, 52
gamma = 0°.....	105
grass strip	232
ground element	52, 216, 217
hemispherical illuminance	235
horizontal illuminance	235
IES	41
illumination class.....	244
illumination class wizard	244
illumination point.....	106
image processing software.....	169

insert a point.....	51
<i>Insert Coordinates</i>	52
interchanges.....	256
LEO.....	70
Light distribution curve.....	105
Light Scenes.....	140
LTLi.....	41
luminaire	
outside of a room.....	52
<i>Luminaire Centre</i>	110
Luminaire Selection.....	39, 40
luminaire tree.....	102
luminance diagram.....	275
luminous intensity.....	106
luxmeter.....	167
maintenance factor.....	243
maintenance factors.....	65
maintenance plan method.....	65
maintenance value.....	67, 104
material.....	182
median.....	232
monitor output.....	271
<i>mounting height</i>	103
new value.....	104
Not installed PlugIns.....	40
observers.....	231
Obstruction.....	163
omni directional glare control.....	275
Optimisation.....	239
<i>Outer Edge</i>	110
output	
combinations of output types.....	277
multiple output simultaneously.....	46
screen.....	46
output selection.....	46
parking lane.....	228, 232
PDF.....	278
photometric requirements.....	234, 243
pick grid.....	177
<i>Pole</i>	238
print output.....	271
print preview.....	272
project tree.....	39, 104
Project tree.....	34
Project Tree.....	38
properties.....	48
Quick Street Planning Wizard.....	225, 242
<i>reflection factor</i>	49, 182
rendering.....	273
Result Output.....	217
right mouse button.....	36
roadway.....	227, 254
selection filter.....	108
semicylindrical illuminance.....	235
sidewalk.....	228
sky models.....	159
sky point azimuth.....	159
sky point height.....	159
solar azimuth.....	159
solar height.....	159

Start Angle.....	113
<i>Street Element</i>	229
street luminaires.....	237
streets.....	224
sunlight.....	164
surface name	183
<i>Symmetrical</i>	110
tables.....	271
<i>Tarmac</i>	230
task area	52
Task area	
DIN 5035 T7	200
EN 12464.....	200
technical data of the luminaires	104
Technical Report of the European committee for standardisation CEN/TR 13201-1.....	228
texture	
rotate a texture	94
textures	
file formats	94
Import textures	95
Tool tips for calculation results	167
Training	3
UGR.....	214
UGR table	214
viewing direction.....	215
uniformity.....	243
Upward Light Ratio	220
user interface.....	34
valuation field	236, 244
<i>vaults</i>	80
vertical illuminance.....	235
video.....	309
views	171
www.dial.de	
Updates	3

Appendix A Keyboard Short Cuts

General

Online help	F1
Display Guide-window	F4

Edit

Rename	F2
Cut	Ctrl+X
Copy	Ctrl+C
Paste	Ctrl+V
New	Ctrl+N
Open	Ctrl+O
Save	Ctrl+S
Print	Ctrl+P
Undo	Ctrl+Z
Redo	Ctrl+Y
Delete	Del

View/CAD window

3D Standard view	F8
Floor plan (X-Y level symbolic)	F9
Front view (X-Z level)	F10
Side view (Y-Z level)	F11
Wireframe display	Ctrl+W
Help rays for luminaires	Ctrl-R
Show isolines in CAD	Ctrl-I
Show false colours in CAD	Ctrl-F
Zoom in	Ctrl+'+'
Zoom out	Ctrl+'-'
Measure distance	Ctrl+M
Cancel selection	Ctrl+Q
Ignore raster	Left mouse button + "Shift"
Roam scene up, down, left, right	Left mouse button + "Ctrl"
Change view	Left mouse button + "Shift"
Change perspective	Perspective mode via left mouse button + "Ctrl"

Furniture

Rotate mode/ change scaling	"TAB" key
Move origin	Left mouse button + "Alt"
Move in z-direction	Left mouse button + "Ctrl"
Change working plane in 3D	Left mouse button + "Space"
Mark several surfaces	Left mouse button + "Ctrl"

Colours/Textures

Change a surface	Left mouse button + "Shift"
------------------	-----------------------------

Filter

for a luminaire
for all luminaires

Left mouse button + "Shift"
Left mouse button + "Ctrl"

Help lines

End
Move whole lines

"Esc"
Left mouse button + "Alt"

Camera

Save position 1
Save position 2
Save position 3
Save position 4
Save position 5
Save position 6
Save position 7
Save position 8
Save position 9
Save position 10
Redo position 1
Redo position 2
Redo position 3
Redo position 4
Redo position 5
Redo position 6
Redo position 7
Redo position 8
Redo position 9
Redo position 10

Ctrl+1
Ctrl +2
Ctrl +3
Ctrl+4
Ctrl+5
Ctrl+6
Ctrl+7
Ctrl+8
Ctrl+9
Ctrl+0
Alt+1
Alt+2
Alt+3
Alt+4
Alt+5
Alt+6
Alt+7
Alt+8
Alt+9
Alt+0